

2021 Catálogo General • General Catalogue

GRES ARAGÓN

SOLUTIONS FOR LIVING

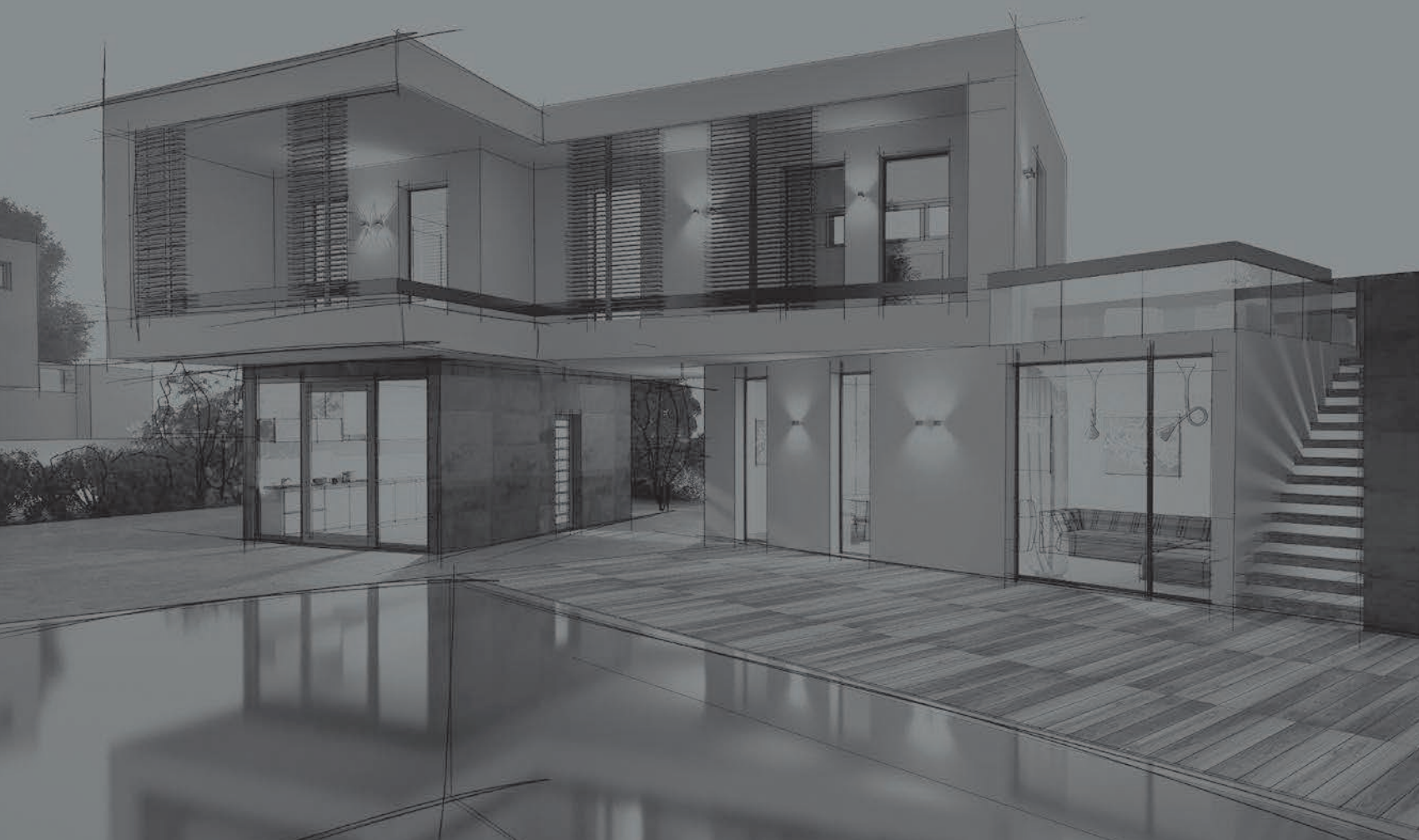

EXTERIORES EXTERIORS **INTERIORES** INTERIORS **PISCINAS** POOLS **FACHADAS** FAÇADES **ESCALERAS** STAIRS

GRES ARAGÓN

SOLUTIONS FOR LIVING

Cuando en 1944 nace la empresa familiar **Gres Aragón**, nada hacía suponer que 75 años más tarde, lo que era un taller de alfarería, se habría convertido en una empresa que produce más de 1.000 referencias de gres natural y porcelánico, vendidas en un centenar de países, y está presente, con su buen hacer tanto, en la piscina de una residencia privada como en la fachada cerámica de un edificio inteligente.

Fruto del esfuerzo, la innovación y las inversiones realizadas a lo largo de la historia, **Gres Aragón** ha desarrollado una gran gama de productos diferenciados en función de su tipología, así, encontramos, además de la marca **Gres Aragón**, **Acepool**, la línea de piscinas e instalaciones deportivas, **Faveker**, división que desarrolla las fachadas ventiladas y **Bioklinker**, tecnología de vanguardia para el pavimento industrial antibacteriano.

When the family-run company **Gres Aragón** was first founded in 1944, no one could possibly imagine that 75 years later, that original potter's workshop would have turned into a company which produces over 1,000 natural-look stoneware and porcelain tile models, sold in over one hundred different countries or that, thanks to its skilful efforts, its products would be found in places as wide-ranging as swimming pools in private homes or on the façades of smart buildings.

As a result of the effort, innovation and investments made throughout history, **Gres Aragón** has developed a wide range of differentiated products depending on their type, so we find, in addition to the **Gres Aragón** brand, **Acepool**, the pool and sports facilities line, **Faveker**, a division that develops ventilated facades and **Bioklinker**, avant-garde technology for antibacterial industrial flooring.

ACEPOOL
WELLNESS CERAMICS - GRES ARAGÓN

FAVEKER
ARCHITECTURAL CERAMICS

BIOKLINKER
TECHNOLOGY BY GRES ARAGÓN

ST
YLE

A WAY OF THINKING AND THE ART OF LIVING (AND A HOME)



Índice

Index

4	Introducción Introduction	158	Línea técnica - ACEPOOL ACEPOOL - Technical range
6	Declaración Ambiental de Producto Environmental Product Declaration	160	Piscinas privadas
		174	Piscinas deportivas
		182	Coronación
12	Pavimentos porcelánicos Porcelain floor tiles	200	Realizaciones ACEPOOL ACEPOOL Projects
16	Urban	202	Bioklinker
26	Tibet	204	Pavimento industrial - ACIKER PLUS ACIKER - Industrial floor tiles
36	Marble	212	Área contract - FAVEKER FAVEKER - Contract area
42	Ordesa	216	Realizaciones Projects
52	Ocean	224	Información técnica Technical information
60	Ítaca		
70	Pavimentos esmaltados y naturales Glazed and Natural floor tiles		
74	Mytho		
80	Esmaltados Classic		
86	Columbia		
92	Antic		
98	Stone		
104	Retro/Alcázar		
110	Orión		
116	Capri		
122	Tiras/Strips		
126	Natural		
136	Natural Classic		
142	Quarry		
148	Cotto		
154	Jasper		

Como a ti, Just like you...

En Gres Aragón nos gusta que el aire libre entre en nuestro hogar.

At Gres Aragón, we enjoy the home's indoor and outdoor areas.

Por eso nuestros suelos y revestimientos puedes usarlos en el interior y en el exterior de tu casa. Están elaborados con arcillas selectas cocidas a más de 1.200°C y son perfectos tanto para andar descalzo en pleno verano como para resistir las heladas del invierno. Son pavimentos y revestimientos cerámicos manufacturados mediante extrusión o prensado, eligiendo la mejor tecnología en cada caso.

That is why our wall and floor tiles can be used both inside and outside the home. Because they are made of carefully selected clays fired at over 1200°C, they are equally suitable for walking on barefoot in the summer months or for withstanding hard winter frosts. Our wall and floor tiles are either extruded or pressed, using the very best technology in each case.

GRES ARAGÓN

SOLUTIONS FOR LIVING

En Gres Aragón nos gustan los colores y la variedad de formas y estilos.

Esmaltamos nuestro gres y ampliamos la paleta de tonos para cada una de nuestras más de 1.000 referencias, y creamos piezas de acabado, especiales, que aportan soluciones arquitectónicas y de las que logran redondear un ambiente, añadiendo ese plus de calidad, elegancia y confort que solo nosotros ofrecemos.

At Gres Aragón, we love colours and varying shapes and styles.

We glaze our stoneware tiles, adding new colours to the available colour spectrums of our over 1,000 tile models. We also manufacture special tile pieces so as to provide tile-laying and building solutions and to help finish off settings with that extra touch of quality, elegance and comfort only synonymous with Gres Aragón.



En Gres Aragón también nos gustan los retos.

Creamos fachadas y acabados para los edificios más modernos e históricos. Nos enorgullece trabajar con arquitectos tan prestigiosos como Rafael Moneo a través de nuestra filial Faveker. Y lo mejor es que los materiales, las técnicas y el equipo de profesionales, trabajan con el mismo nivel de calidad y compromiso ya sea para que se instale pavimento hidráulico en tu hogar o para restaurar la cúpula de una basílica barroca.

At Gres Aragón, we also enjoy a good challenge.

We help to create façades and finishes for buildings ranging from the most modern to the most historical. We are proud to work with architects as eminent as Rafael Moneo through our subsidiary Faveker. And best of all, our materials, techniques, and team of professionals always stand out for their unwavering quality and commitment, whether the project in question involves an encaustic cement floor for your home or the restoration of a Baroque basilica's dome.





En Gres Aragón nos gusta ofrecer seguridad, higiene, durabilidad y resistencia con nuestros materiales.

Por eso nuestros pavimentos, escaleras, terrazas y piscinas tienen alta resistencia al tránsito, son antibacterianos, impermeables y antideslizantes. Están hechos para durar.

At Gres Aragón, we guarantee hygiene, safety, durability and a high resistance.

Floors, stairs, terraces and swimming pools clad in our products stand out for their high resistance to traffic, imperviousness, anti-bacterial properties and non-slip grip. Our products are made to last.



¡En Gres Aragón nos gusta que disfrutes bañándote!

Ofrecemos productos y sistemas cerámicos para piscinas de interior y exterior, deportivas, instalaciones wellness y balnearias. Gracias a nuestro amor por el detalle y al exclusivo catálogo de piezas especiales de acabado, nos adaptamos a las necesidades técnicas de cada proyecto y las preferencias de nuestros clientes.

At Gres Aragón, we are glad you enjoy a good swim!

We make ceramic tile products and systems for indoor and outdoor pools and sports pools, in addition to wellbeing facilities and spas. Thanks to our passion for detail and our exclusive range of special tile pieces, we have products able to meet all possible preferences and the technical needs of each and every project.

En Gres Aragón también cuidamos de la Tierra y de nuestra tierra.

Porque estamos comprometidos mediante:

- Una gestión sostenible de nuestros productos.
- La generación de 0 residuos.
- La fijación de la población rural.
- Compartir la riqueza en nuestro entorno.



At Gres Aragón, we also care for the planet and the local environment.

Because we are committed to:

- Sustainable management of our products.
- Zero waste.
- Conserving the rural population.
- Sharing our wealth locally.

Y, sobre todo, en Gres Aragón nos gustan los desafíos, cada nuevo proyecto, cada nuevo cliente, es una oportunidad para adaptarnos a sus necesidades y... sus sueños.

And, above all, at Gres Aragón, we love to be faced with new challenges. Each new project and each new client is an opportunity to demonstrate our ability to meet their needs and to make their dreams come true.

GRES ARAGÓN: CONSCIENTEMENTE SOSTENIBLES



Los productos cerámicos de Gres Aragón forman parte de la vida cotidiana de miles de personas, integrados en las construcciones en las que viven y trabajan. Son materiales de origen natural, seguros, duraderos, versátiles y económicos. Estas características son los pilares de su sostenibilidad medioambiental, económica y social. Y, para demostrar su máximo respeto al entorno, Gres Aragón ha obtenido la **Declaración Ambiental de Producto (DAP)**, certificada por AENOR de los materiales cerámicos extruidos (formato 25x25cm. y 33x33 cm.) en todo su ciclo de vida.

LAS 10 RAZONES QUE NOS HACEN SOSTENIBLES:

1.- ORIGEN NATURAL

Los productos cerámicos de Gres Aragón son 100% naturales, puesto que se fabrican básicamente a partir de arcilla, agua y fuego. Las baldosas se someten a un proceso de cocción que supera los 1.000 grados centígrados, temperatura a la que los compuestos orgánicos presentes se descomponen.

2.- PROCESO RESPONSABLE

Las fábricas de productos cerámicos de Gres Aragón en la comarca turolense del Bajo Aragón se sitúan junto a las canteras de arcilla, lo que minimiza los impactos del transporte de las materias primas a la planta. Su ubicación en zonas rurales contribuye a fijar la población y a vertebrar el territorio, proporcionando empleo estable y dinamizando económica y socialmente estas áreas.

Trabajamos en el ecodiseño de embalajes de cartón para reducir el impacto de impresión de tintas y aligerar el peso.

3.- FABRICACIÓN EFICIENTE

Gracias a las fuertes inversiones llevadas a cabo para reducir el consumo de energía y rebajar las emisiones, a través del uso mayoritario de gas natural se logra un proceso productivo más eficiente, al que también contribuyen el bajo consumo de agua y el escaso desperdicio de material cerámico. En Gres Aragón, las aguas residuales generadas en la limpieza de las líneas de esmaltado se reintroducen como agua de amasado en el proceso de extrusión, por lo que no se producen vertidos: reciclamos el 100% del agua en el propio proceso productivo consiguiendo VERTIDO CERO.

Además, los residuos cerámicos generados en la producción se aprovechan como materia prima, lo que da como resultado unos productos cerámicos con hasta el 32% de contenido reciclado en la gama de klinker y de hasta el 45% en gres porcelánico y fachadas Faveker®

4.- EFICIENCIA ENERGÉTICA

Trabajamos en la mejora continua en eficiencia energética: reutilizamos continuamente inversiones para reducir consumos energéticos, destacando inversiones en el horno de cocción para reducir el consumo de gas natural en la fabricación de klinker, renovación de horno de rodillos porcelánico de máxima eficiencia energética, aprovechamiento de calor de hornos en procesos de secado, migración de luminarias a tecnología LED, renovación de flota de vehículos de diésel a eléctricos (carretillas para movimentación producto acabado y vehículos LGV para movimentación de producto intermedio) En nuestra gama de fachadas ventiladas de Faveker®, las piezas cerámicas contribuyen al aislamiento de la temperatura de la envolvente del edificio, incrementando el confort del usuario en su interior. Por ello, son soluciones constructivas óptimas para el diseño de Edificios de Energía de consumo Casi Nulo (EECN).

5.- SEGURIDAD

Las soluciones constructivas cerámicas de Gres Aragón no arden, por lo que no producen llamas, humos ni gases tóxicos. Las fachadas y cubiertas cerámicas dan lugar a envolventes con un excelente nivel de protección frente a fenómenos meteorológicos extremos. Asimismo, las baldosas cerámicas son antideslizantes y productos propios como Bioklinker®, aplicables a pavimentos y fachadas, tienen un efecto antibacteriano esencial en espacios que exigen un extra de seguridad e higiene, como los relacionados con la alimentación o la sanidad, además de ser un producto eficaz contra olores y manchas. Además, recientemente hemos ampliado la gama antibacteriana a pavimentos porcelánicos y fachadas digitales.

6.- SALUD

Gracias a su porosidad, los productos cerámicos de Gres Aragón tienen un excelente comportamiento frente a la humedad, absorbiéndola cuando es alta y liberándola cuando el ambiente es más seco. Tampoco emiten compuestos orgánicos volátiles (COV), gas radón ni otras sustancias tóxicas, por lo que son el material perfecto para que la vivienda goce de una calidad del aire interior saludable.

7.- DURABILIDAD

Los materiales cerámicos de Gres Aragón tienen una vida útil larga que se traduce en un ahorro económico para los propietarios de las viviendas en concepto de renovación y de mantenimiento. Además, presentan una propiedad única: embellecen con el paso del tiempo.

8.- INNOVACIÓN Y VANGUARDIA

El catálogo de Gres Aragón ofrece a los arquitectos y diseñadores infinidad de soluciones creativas en cuanto a texturas, colores, formas y volúmenes, gracias a la tecnología de inyección digital KLINKJET que permite trasladar todo tipo de diseños a la cerámica. Esta versatilidad hace posible adaptarse a los nuevos requisitos, técnicas y métodos constructivos del siglo XXI.

9.- CONSERVACIÓN DEL PATRIMONIO

Los productos cerámicos de Gres Aragón no se deterioran con el paso del tiempo y se caracterizan por sus altas prestaciones técnicas a un precio de mercado muy asequible, lo que los convierte en sostenibles también desde el punto de vista económico.

10.- ECONOMÍA CIRCULAR

La Lista Europea de Residuos (LER) clasifica a los residuos de construcción y demolición cerámicos como inertes y no peligrosos, por lo que son altamente reciclables en diferentes usos, como material de relleno y estabilización de carreteras, áridos para hormigón y morteros, tierra batida en pistas de tenis, sustrato de plantas o elemento de cobertura para agricultura. Del mismo modo, al no alterar la calidad del agua, permiten aprovechar la lluvia mediante sistemas de drenaje para recogerla, almacenarla y poder usarla de nuevo.

Gres Aragón ceramic tiles are part of the daily life of thousands of people, integrated into the buildings where they live and work. They are natural origin materials, safe, durable, versatile and economical. These characteristics are the pillars of its environmental, economic and social sustainability. And, to demonstrate its maximum respect for the environment, Gres Aragón has obtained the Environmental Product Declaration (DAP), certified by AENOR for extruded ceramic materials (25x25cm. and 33x33 cm. format) throughout their life cycle.

THE 10 REASONS THAT MAKE US SUSTAINABLE:

1.- NATURAL ORIGIN

Gres Aragón ceramic products are 100% natural, since they are basically made from clay, water and fire. The tiles are manufactured by a tunnel kiln process that exceeds 1,000 °C, a temperature at which the present organic compounds, decompose.

2.- RESPONSIBLE PROCESS

Gres Aragón tile factories in Bajo Aragón area (Teruel – Spain), are located next to the clay quarries, which minimizes the impacts of the transport of raw materials to the plant. Its location in rural areas contributes to establishing the population and structuring the territory, providing stable employment and dynamiting these areas economically and socially.

We work on the eco-design of cardboard packaging to reduce the impact of printing inks and lighten the weight.

3.- EFFICIENT MANUFACTURING

Thanks to the big investments carried out to reduce energy consumption and reduce emissions, a more efficient production process is achieved through the majority use of natural gas, added to low water consumption and low material waste that also contribute to this achievement. At Gres Aragón, the wastewater generated in the cleaning of the glazing lines is reintroduced as mixing water in the extrusion process, so there is no waste: we recycle 100% of the water in the production process itself achieving zero dumping of wastewater.

In addition, ceramic waste generated in production is re-used as raw material, which results in ceramic products with up to 32% recycled content in the klinker range and up to 45% in porcelain tiles and Faveker® façades.

4.- ENERGY EFFICIENCY

We work on continuous energy efficiency improvements: we make investments to reduce energy consumption, and it should be noted the optimizing of the furnace in order to reduce gas consumption during the klinker production process, we also carried out the renovation of a porcelain roller kiln with maximum energy efficiency, the use of heat from tunnel kilns in drying processes, migration of lighting to LED technology, renovation of the fleet of diesel to electric vehicles (trucks for handling finished product and LGV vehicles for moving product intermediate).

In our ventilated façades' range Faveker®, our tiles contribute to the insulation of the temperature of the building envelope, increasing the comfort of the people who lives in. Therefore, they are optimal constructive solutions for the design of Net Zero Energy Building (NZEB).

5.- SECURITY

Gres Aragón ceramic tiles do not burn, so they do not produce flames, fumes or toxic gases. The ceramic façades and covers provide an excellent level of protection against extreme meteorological phenomena. Likewise, ceramic tiles are non-slip and products with technology Bioklinker®, applicable to floors and facades, have an essential antibacterial effect in spaces that require extra safety and hygiene, such as those related to food or health, in addition to being an effective product against odours and stains. In addition, we have recently expanded the antibacterial range to porcelain tiles and digital façades.

6.- HEALTH

Thanks to their porosity, Gres Aragón ceramic products have an excellent behaviour against humidity, absorbing it when it is high and releasing it when the environment is drier. They also do not emit volatile organic compounds (VOCs), radon gas, or other toxic substances, making them the perfect material for a home to enjoy healthy indoor air quality.

7.- DURABILITY

Gres Aragón ceramic materials have a long useful life that bring economic savings for homeowners in terms of renovation and maintenance. In addition, they have a unique property: they beautify over time.

8.- INNOVATION AND VANGUARD

Gres Aragón catalogue offers architects and designers an infinity of creative solutions in terms of textures, colours, shapes and volumes, thanks to the digital injection technology KLINKJET that allows all kind of designs to be transferred to ceramics. This versatility makes it possible to adapt to the new requirements, techniques and construction methods of the 21st century.

9.- CONSERVATION OF HERITAGE

Gres Aragón tiles do not deteriorate over time and are characterized by their high technical performance at a very affordable market price, which makes them also sustainable from an economic point of view.

10.- CIRCULAR ECONOMY

The European Waste List (EWL) classifies ceramic construction and demolition waste as inert and non-hazardous, so it is highly recyclable in different uses, such as filling material and road stabilization, aggregates for concrete and mortars, beaten earth in tennis courts, plant substrate or covering element for agriculture. In the same way, by not altering the quality of the water, they allow to take advantage of the rain through drainage systems to collect it, store it and be able to use it again.

Declaración Ambiental de Producto (DAP) certificada por Aenor y con reconocimiento europeo.



Environmental Product Declaration (EPD) certified by AENOR with European recognition.

Las DAP son documentos que ofrecen información clave sobre el comportamiento ambiental de los productos a lo largo de su ciclo de vida. Se basan en la norma UNE-EN ISO 14025, que establece los principios y especifica los procedimientos para desarrollar dichas declaraciones. En el caso de los productos de construcción, se basan también en la norma UNE-EN 15804 que establece las reglas de categoría de producto básicas específicas para estos materiales.

The EPD are documents that provide key information on the environmental performance of products throughout their life cycle. They are based on the UNE-EN ISO 14025, which establishes the principles and specifies the procedures for developing such statements. In the case of construction products, these documents are also based on the UNE-EN 15804, which establishes the basic specific rules of product category for these materials.



COLECCIONES
COLLECTIONS

URBAN

TIBET

MARBLE

ORDESA

OCEAN

ITACA

MYTHO

ESM. CLASSIC

COLUMBIA

Tabla para la búsqueda de colecciones según estilo y/o espacios.

Table for the search of collections according to style and/or spaces.

	ESTILOS STYLES						ESPACIOS SPACES		
	URBAN	TIBET	MARBLE	ORDESA	OCEAN	ITACA	MYTHO	ESM. CLASSIC	COLUMBIA
MADERAS Wood				● pg.42					
PIEDRAS NATURALES Natural Stone		● pg.26	● pg.36			● pg.60			● pg. 86
CEMENTOS Concrete	● pg.16								
CLÁSICO RÚSTICO Classical Rustic							● pg.74	● pg.80	
ACUÁTICO Aquatic					● pg.52				
HIDRÁULICO Hydraulic									
FACHADA Façade							● pg.76	● pg.82	
ESCALERAS Stairs	● pg.21	● pg.31	● pg.41	● pg.47		● pg.65	● pg.79	● pg.85	● pg.91
TERRAZAS Terraces	● pg.18	● pg.28	● pg.38	● pg.44		● pg.62		● pg.82	● pg. 88
PORCHES Porches	● pg.18	● pg.28	● pg.38	● pg.44		● pg.62		● pg.82	● pg. 88
INTERIOR (Desde CTE Clase 0-1) Indoor (From CTE Class 0-1)	● pg.18	● pg.28	● pg.38	● pg.44	● pg.54		● pg.76		
EXTERIOR (Desde CTE Clase 2-3) Outdoor (From CTE Class 2-3)	● pg.18	● pg.28	● pg.38	● pg.44	● pg.54	● pg.62		● pg.82	● pg. 88
PISCINA PÚBLICA RECREATIVA Y PRIVADA Public recreational and private pool	● pg. 162-167 184-185 197	● pg. 162-167 184-185 197		● pg. 162-167 184-185 197	● pg. 162-167 184-185 197	● pg. 162-167 184-185 197			● pg. 172-173 186-187 196
PISCINA DEPORTIVA Sports pool									
INDUSTRIA Industry									

ESMALTADOS Glazed tiles / NATURALES Unglazed tiles											CORONACIONES Edgings tiles		BIO-KLINKER
ANTIC	STONE	RETRO/ ALCAZAR	ORIÓN	CAPRI	TIRAS	NATURAL	NAT. CLASSIC	QUARRY	COTTO	JASPER	GA SPA	FINLANDÉS	ACIKER
				●									
				pg. 116									
	●		●										
	pg.98		pg.110										
●						●	●	●	●	●			
pg.92						pg.126	pg.136	pg.142	pg.148	pg.154			
		●											
		pg.104											
			●	●	●	●			●				
			pg.112	pg.118	pg.122	pg.128			pg.150				
●	●		●	●		●	●		●	●			
pg.97	pg.103		pg.115	pg.121		pg.131	pg.141		pg.152	pg.159			
	●		●	●		●	●	●	●	●			
	pg.100		pg.112	pg.118		pg.128	pg.138	pg.144	pg.150	pg.156			
	●		●	●		●	●	●	●	●			
	pg.100		pg.112	pg.118		pg.128	pg.138	pg.144	pg.150	pg.156			
●		●											
pg.94		pg.106-109											
	●		●	●	●	●	●	●	●	●			
	pg.100		pg.112	pg.118	pg.122	pg.128	pg.138	pg.144	pg.150	pg.156			
			●	●		●			●				
			pg.172-173 186-187 196	pg.172-173 186-187 196		pg.172-173 186-187 196			pg.172-173 186-187 196				
											●	●	
											pg.190	pg.192	
													●
													pg.204

Descripción del catálogo

Catalogue description

Imagen representativa de modelo y color
Model and color representative image

Identificativo serie
Serie identifier



URBAN

PORCELÁNICO PORCELAIN TILES

Colores / Colors

Blanco

Gris

Beige

Caoba

Grafito

Los colores son indicativos.
Colors are just indicative.

	PORCELÁNICO PORCELAIN	
	ESMALTADO GLAZED	
	Características dimensionales Dimension tolerance	<1% / <0,8% máx 2 mm
	Absorción de agua Water absorption	E<0,5%
	Coeff. Dilatación térmica lineal Linear thermal expansion coefficient	5,8x10 ⁻⁶ /°C
	Resistencia a la flexión Breaking strength	>40N/mm ²
	Resistencia a la abrasión superficial Resistance to surface abrasion	Antideslizante / Anti slip Gris, Beige, Blanco PEI 4 Caoba, Grafito PEI 2
	Resistencia a las manchas Resistance to stains	clase 5 class 5
	Péndulo (CTE) Not required out of Spain	Antideslizante clase 3 Anti slip class 3
	A pie descalzo Barefoot slip resistance	Liso / Smooth A
	A pie calzado Slip resistance with footwear	Antideslizante / Anti slip R11 Liso / Smooth RB
	Resistencia al cuarteo Chipping resistance	si/yes
	Resistencia a la helada Frost resistance	✓
	Resistencia al choque térmico Resistance to thermal shock	✓
	Resistencia química Chemical resistance	✓
	Destonificado Shade variation	V2 ligero light

16 PAVIMENTOS FLOOR TILES

(cm) Formatos / Sizes

30x30

30x60

60x60

60x120



Urban Beige 60x60

Tamaños disponibles
Available sizes

Características técnicas
Technical information

Modelo representado en la fotografía
Model represented in photo

Fotografía de ambiente
Ambiance photo

Nombre producto

Product name

PELDAÑO REDONDEADO 30

ROUNDED STAIR-TREAD 30

Antideslizante · Anti slip
[297x330x14 mm]

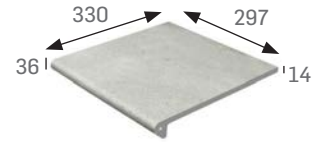

Cotas
Dimensions

Blanco Cod. 970031 [PZ287]
Gris Cod. 970032 [PZ287]
Beige Cod. 970033 [PZ287]
Caoba Cod. 970182 [PZ287]
Grafito Cod. 970092 [PZ287]

Color
Color

Código de
producto
Product code

Código de
precio
Price code

Cotas
Dimensions

URBAN

PORCELÁNICOS
PORCELAIN TILES

Colores / Colors

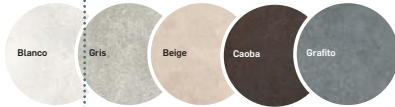

BASE 30x30 TILE 30x30

[297x297x10 mm]

Blanco Antideslizante / Anti slip Cod. 904237 (MC479)
Gris Antideslizante / Anti slip Cod. 904246 (MC479)
Beige Antideslizante / Anti slip Cod. 904239 (MC479)
Caoba Antideslizante / Anti slip Cod. 905634 (MC479)
Grafito Antideslizante / Anti slip Cod. 904763 (MC479)



BASE 30x60 TILE 30x60

[297x597x10 mm]

Blanco Antideslizante / Anti slip Cod. 904245 (MC479)
Gris Antideslizante / Anti slip Cod. 904246 (MC479)
Beige Antideslizante / Anti slip Cod. 904247 (MC479)
Caoba Antideslizante / Anti slip Cod. 905635 (MC479)
Grafito Antideslizante / Anti slip Cod. 904765 (MC479)
Blanco Liso / Smooth Cod. 904241 (MC479)
Gris Liso / Smooth Cod. 904242 (MC479)
Beige Liso / Smooth Cod. 904243 (MC479)
Caoba Liso / Smooth Cod. 905636 (MC479)
Grafito Liso / Smooth Cod. 904764 (MC479)



BASE 60x60 TILE 60x60

[597x597x10 mm]

Blanco Antideslizante / Anti slip Cod. 904253 (MC479)
Gris Antideslizante / Anti slip Cod. 904254 (MC479)
Beige Antideslizante / Anti slip Cod. 904255 (MC479)
Caoba Antideslizante / Anti slip Cod. 905637 (MC479)
Grafito Antideslizante / Anti slip Cod. 904767 (MC479)
Blanco Liso / Smooth Cod. 904249 (MC479)
Gris Liso / Smooth Cod. 904250 (MC479)
Beige Liso / Smooth Cod. 904251 (MC479)
Caoba Liso / Smooth Cod. 905638 (MC479)
Grafito Liso / Smooth Cod. 904768 (MC479)

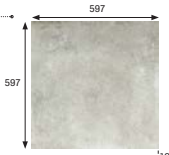

BASE 60x120" TILE 60x120"

[600x1200x10,4 mm]

Blanco ** Antideslizante / Anti slip Cod. 905234 (MC587)
Gris ** Antideslizante / Anti slip Cod. 905233 (MC587)
Beige ** Antideslizante / Anti slip Cod. 905236 (MC587)
Grafito ** Antideslizante / Anti slip Cod. 905235 (MC587)
Blanco Liso / Smooth Cod. 904723 (MC587)
Gris Liso / Smooth Cod. 904722 (MC587)
Beige ** Liso / Smooth Cod. 904873 (MC587)
Grafito ** Liso / Smooth Cod. 904874 (MC587)



** Producto disponible bajo pedido. Consultar plazos de entrega con fábrica.
** Product available under demand. Ask for delivery terms to factory.

18

PAVIMENTOS FLOOR TILES

	Espesor (mm) Thickness (mm)	U.M.*	U.M./Caja U.M./Box	U.M./Palet U.M./Pallet	Pzs./U.M. Pcs./U.M.	Pzs./Caja Pcs./Box	Kg./U.M. Kg./U.M.	Kg./Caja Kg./Box	Kg./Palet Kg./Pallet
Base 30x30 Tls 30x30	10	m ² /sqm	0,99	71,29	11,11	11	21,54	21,33	1536
Base 30x60 Tls 30x60	10	m ² /sqm	1,08	64,86	5,55	6	21,65	23,38	1403
Base 60x60 Tls 60x60	10	m ² /sqm	1,44	60,48	2,78	4	22,53	32,44	1362
Base 60x120 Tls 60x120	10,4	m ² /sqm	1,45	43,5	1,37	2	25,08	34,6	1017

* Unidad de Medida. Los artículos medidos en m² o m³ se sirven contando la junta normal entre piezas. Anchura recomendada de la junta de colocación: Consultar pág. 15.
* Unit of Measure. Items measured in sqm or m³ are delivered assuming average joint between pieces. Recommended joint width: See pg. 15.

Espesor
Thickness

Unidad de medida
Unit of measure

Datos de embalaje
Packing data

Nº página
Page number



Urban Grafito 60x60

19
PAVIMENTOS FLOOR TILES

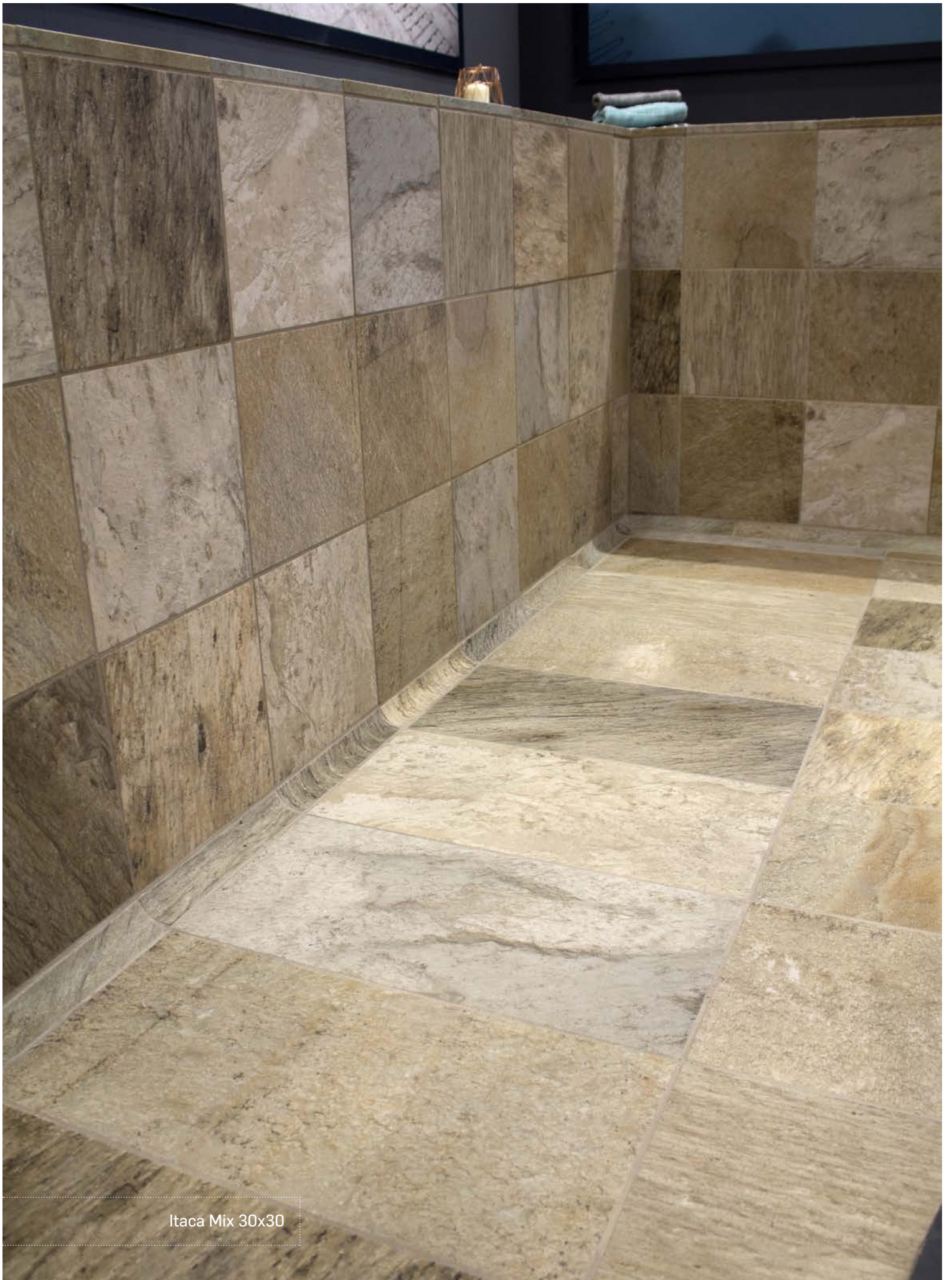

Itaca Mix 30x30

Porcelánicos

Porcelain Tiles



GRES PORCELÁNICO

En Gres Aragón hemos ido un paso más allá ofreciendo productos porcelánicos con excelentes prestaciones, así como con un índice de absorción de agua inferior.

El espesor de este tipo de productos es más ligero, entre 8 y 18 mm, sin embargo, sigue ofreciendo excelentes cualidades de dureza y antideslizamiento, entre otras. En todas las colecciones también se fabrican kits completos en los que se facilitan las baldosas acompañadas de peldaños, esquinas, rodapiés, zanquines, vierteaguas y pasamanos. Además, ofrecemos un acabado global con todas las piezas necesarias para la construcción de piscinas privadas.

PORCELAIN TILES

At Gres Aragón we have gone a step further by offering top-performing porcelain products and with a lower rate of water absorption.

These products are thinner — between 8 and 18 mm — but they still offer excellent hardness and anti-slip qualities, among others. In all ranges we include complete kits of tiles, steps, corners, skirtings, strings and handrails. We also offer all the necessary pieces for constructing private pools.



Según norma ISO 22196:2011 nuestra gama porcelánico tiene un índice de eficacia bactericida R>2, que equivale a una reducción del 99% de las bacterias.

According to ISO 22196: 2011 our porcelain range has a bactericidal efficacy index R> 2, which is equivalent to a 99% reduction in bacteria.



PORCELÁNICO / PORCELANIC TILES

Rejilla monocompact ranurada Monocompact grooved grid

En **rejillas porcelánicas** los agujeros siempre deben ir paralelos al vaso para una mayor resistencia, con canal de 250 mm. de ancho.

Install the **porcelanic grids** with the holes always parallel to the pool vessel to get a greater resistance, with a 250 mm. channel wide.

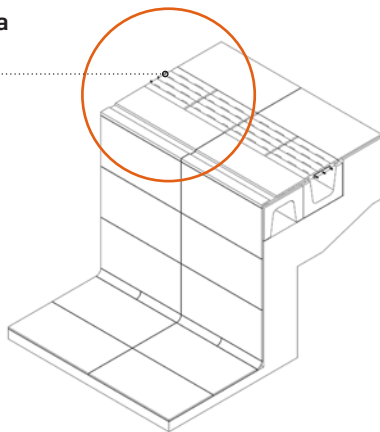

KLINKER

Rejilla cerámica monocompact Monocompact ceramic grid

En **rejillas klinker** los agujeros siempre deben ir perpendiculares al vaso para una mayor resistencia, con canal de 250 mm. de ancho.

Install the **klinker grids** with the holes always perpendicular to the pool vessel to get a greater resistance, with a 250 mm. channel wide.

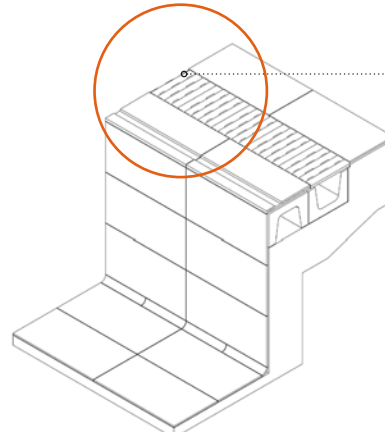

Colocación de pavimentos de las familias porcelánicas

Laying instructions for porcelain tiles families

Se seguirán las recomendaciones generales de preparación del soporte, colocación y limpieza, teniendo en cuenta las siguientes particularidades en el replanteo:

- Colocación de solo bases: la junta recomendada entre bases es de 3 mm , quedando la media nominal modulada a dicho ancho de junta.
- Colocación de bases combinadas con piezas especiales: la junta recomendada entre bases y entre piezas especiales es de 6 mm.

Take into account the following recommendations concerning the support preparation, laying and cleaning process:

- Laying instructions only basic tiles: we recommend to use a joint of 3 mm between tiles (taking into account that the nominal size should modulate with the joint width).
- Laying instructions of basic tiles combined with special pieces: we recommend to use a joint between basic tiles and between special pieces of 6 mm.

En los siguientes gráficos se muestra el modo recomendado de colocar bases y piezas especiales.

We show in the following graphs the recommended way to lay basic tiles and special pieces.

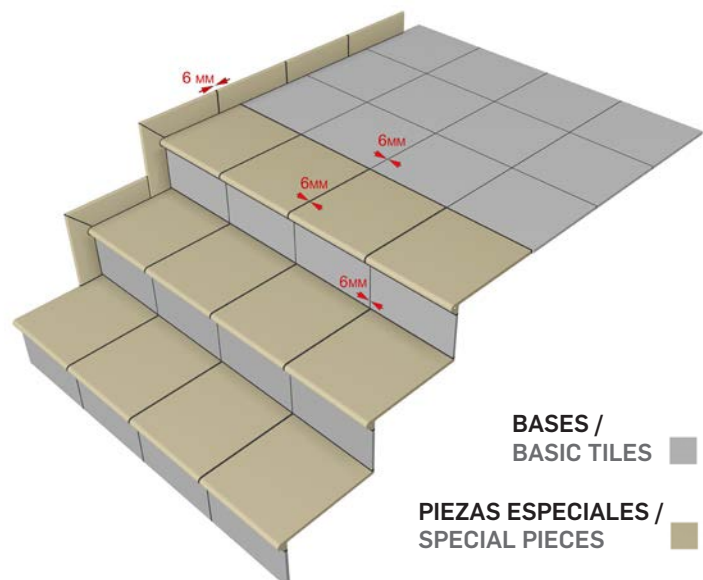

URBAN

PORCELÁNICOS PORCELAIN TILES

Colores / Colors



Blanco



Gris



Beige

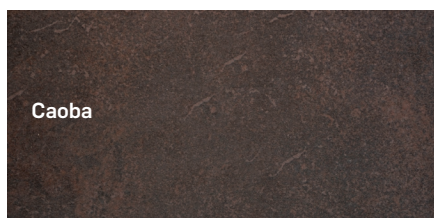

Caoba



Grafito

Los colores son indicativos.
Colors are just indicative.

(cm) Formatos / Sizes



30x30

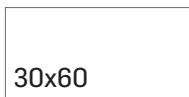



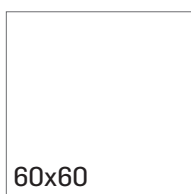



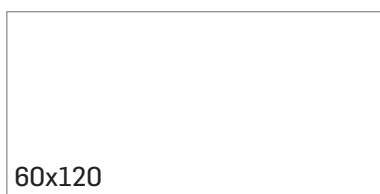









30x60



60x60



60x120

	PORCELÁNICO PORCELAIN	
	ESMALTADO GLAZED	
	Características dimensionales Dimension tolerance	<1% / <0,6% máx 2 mm
	Absorción de agua Water absorption	E≤0,5%
	Coef. Dilatación térmica lineal Linear thermal expansion coefficient	5,8x10 ⁻⁶ xC ⁻¹
	Resistencia a la flexión Breaking strength	>40N/mm ²
	Resistencia a la abrasión superficial Resistance to surface abrasion	Antideslizante / Anti slip Gris, Beige, Blanco PEI 4 Caoba PEI 3 , Grafito PEI 2 Liso / Smooth Gris, Beige, Blanco PEI 4 Caoba PEI 3 , Grafito PEI 2
	Resistencia a las manchas Resistance to stains	class 5 class 5
	Péndulo (CTE) Not required out of Spain	Antideslizante class 3 Anti slip class 3 Liso class 1 Smooth class 1
	A pie descalzo Barefoot slip resistance	Antideslizante / Anti slip C Liso / Smooth A
	A pie calzado Slip resistance with footwear	Antideslizante / Anti slip R11 Liso / Smooth R9
	Resistencia al cuarteo Crazing resistance	sí/yes
	Resistencia a la helada Frost resistance	✓
	Resistencia al choque térmico Resistance to thermal shock	✓
	Resistencia química Chemical resistance	✓
	Destonificado Shade variation	V2 ligero light
	Antibacteriano Antibacterian	R>2 Reducción antibacteriana >99 %



Urban Beige 60x60

URBAN

PORCELÁNICOS
PORCELAIN TILES



Colores / Colors

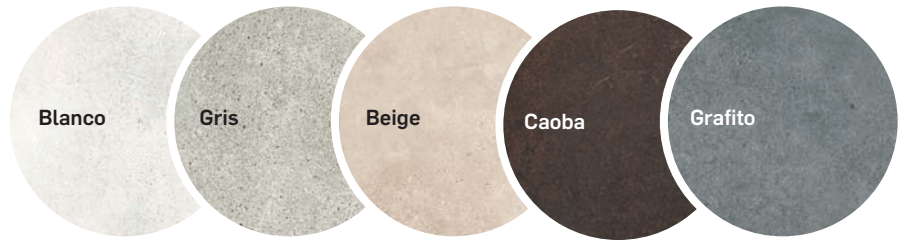

BASE 30x30 TILE 30x30

[297x297x10 mm]

Blanco Antideslizante / Anti slip Cod. 904237 [MC479]
Gris Antideslizante / Anti slip Cod. 904238 [MC479]
Beige Antideslizante / Anti slip Cod. 904239 [MC479]
Caoba Antideslizante / Anti slip Cod. 905634 [MC479]
Grafito Antideslizante / Anti slip Cod. 904763 [MC479]

Caoba Liso / Smooth Cod. 905776 [MC479]

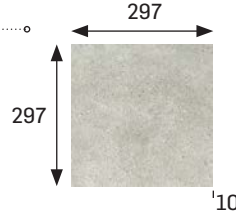

BASE 30x60 TILE 30x60

[297x597x10 mm]

Blanco Antideslizante / Anti slip Cod. 904245 [MC479]
Gris Antideslizante / Anti slip Cod. 904246 [MC479]
Beige Antideslizante / Anti slip Cod. 904247 [MC479]
Caoba Antideslizante / Anti slip Cod. 905635 [MC479]
Grafito Antideslizante / Anti slip Cod. 904765 [MC479]

Caoba Liso / Smooth Cod. 905636 [MC479]



BASE 60x60 TILE 60x60

[597x597x10 mm]

Blanco Antideslizante / Anti slip Cod. 904253 [MC479]
Gris Antideslizante / Anti slip Cod. 904254 [MC479]
Beige Antideslizante / Anti slip Cod. 904255 [MC479]
Caoba Antideslizante / Anti slip Cod. 905637 [MC479]
Grafito Antideslizante / Anti slip Cod. 904767 [MC479]

Blanco Liso / Smooth Cod. 904249 [MC479]
Gris Liso / Smooth Cod. 904250 [MC479]
Beige Liso / Smooth Cod. 904251 [MC479]
Caoba Liso / Smooth Cod. 905638 [MC479]
Grafito Liso / Smooth Cod. 904766 [MC479]

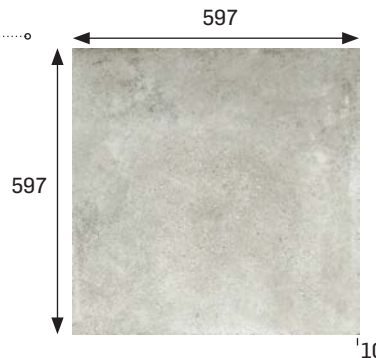

BASE 60x120** TILE 60x120**

[600x1200x10,4 mm]

Blanco ** Antideslizante / Anti slip Cod. 905234 [MC567]
Gris ** Antideslizante / Anti slip Cod. 905233 [MC567]
Beige ** Antideslizante / Anti slip Cod. 905236 [MC567]
Grafito ** Antideslizante / Anti slip Cod. 905235 [MC567]

Blanco Liso / Smooth Cod. 904723 [MC567]
Gris Liso / Smooth Cod. 904722 [MC567]
Beige ** Liso / Smooth Cod. 904873 [MC567]
Grafito ** Liso / Smooth Cod. 904874 [MC567]



** Producto disponible bajo pedido. Consultar plazos de entrega con fábrica
 ** Product available under demand. Ask for delivery terms to factory.

	Espesor (mm) Thickness (mm)	U.M.*	U.M./Caja U.M./Box	U.M./Palet U.M./Pallet	Pzs./U.M. Pcs./U.M.	Pzs./Caja Pcs./Box	Kg./U.M. Kg./U.M.	Kg./Caja Kg./Box	Kg./Palet Kg./Pallet
Base 30x30 Tile 30x30	10	m ² sqm	0,99	71,29	11,11	11	21,54	21,33	1536
Base 30x60 Tile 30x60	10	m ² sqm	1,08	64,86	5,55	6	21,65	23,38	1403
Base 60x60 Tile 60x60	10	m ² sqm	1,44	60,48	2,78	4	22,53	32,44	1362,5
Base 60x120 Tile 60x120	10,4	m ² sqm	1,45	43,5	1,37	2	25,08	34,6	1017

* Unidad de Medida. Los artículos medidos en m² o ml se sirven contando la junta normal entre piezas.
 * Unit of Measure. Items measured in sqm or lm are delivered assuming average joint between pieces.

Anchura recomendada de la junta de colocación: Consultar pág. 15.
 Recommended joint width: See pg. 15.



Urban Gris 60x60



Urban Grafito 60x60

URBAN

PORCELÁNICOS
PORCELAIN TILES



Colores / Colors

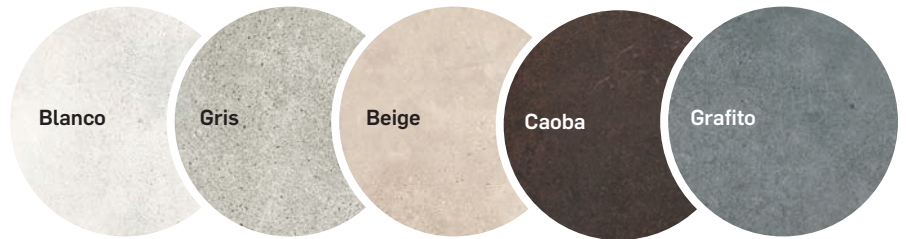

Urban Blanco 30x30, 30x60 y 60x60

	Espesor (mm) Thickness (mm)	U.M.*	U.M./Caja U.M./Box	U.M./Palet U.M./Pallet	Pzs./U.M. Pcs./U.M.	Pzs./Caja Pcs./Box	Kg./U.M. Kg./U.M.	Kg./Caja Kg./Box	Kg./Palet Kg./Pallet
Tabica 15x120 Riser 15x120	10,4	Pz. Pc.	6	264	1	6	4,24	25,4	1119
Peldaño redondeado 30 Rounded stair-tread 30	14	Pz. Pc.	4	256	1	4	3,1	12,6	806
Peldaño redondeado 120 Rounded stair-tread 120	14	Pz. Pc.	2	32	1	2	12,1	24,2	387,2
Peldaño recto 60 Straight stair-tread 60	14	Pz. Pc.	4	144	1	4	5,8	23,4	842
Peldaño recto 120 Straight stair-tread 120	14	Pz. Pc.	2	32	1	2	11,32	22,6	362,2
Tapa peldaño redonda dcha. Right rounded step cover	-	Pz. Pc.	10	**	1	10	0,17	1,7	**
Tapa peldaño redonda izda. Left rounded step cover	-	Pz. Pc.	10	**	1	10	0,17	1,7	**
Tapa peldaño recta Straight step cover	-	Pz. Pc.	10	**	1	10	0,17	1,7	**

* Unidad de Medida. Los artículos medidos en m² o ml se sirven contando la junta normal entre piezas.
* Unit of Measure. Items measured in sqm or lm are delivered assuming average joint between pieces.

** Consultar datos de embalaje con fábrica / ** Ask for packing information to the factory

Anchura recomendada de la junta de colocación: Consultar pág. 15.
Recommended joint width: See pg. 15.

Piezas especiales Special pieces

TABICA 15X120

RISER 15X120

Liso · Smooth
[147x1197x10,4 mm]

Blanco	Cod. 904706	[PZ220]
Gris	Cod. 904707	[PZ220]
Beige	Cod. 904708	[PZ220]
Caoba	Cod. 905639	[PZ220]
Grafito	Cod. 904768	[PZ220]

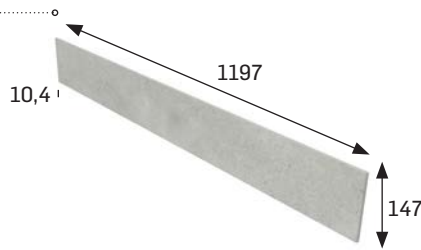

PELDAÑO REDONDEADO 30

ROUNDED STAIR-TREAD 30

Antideslizante · Anti slip
[297x330x14 mm]

Blanco	Cod. 970031	[PZ287]
Gris	Cod. 970032	[PZ287]
Beige	Cod. 970033	[PZ287]
Caoba	Cod. 970182	[PZ287]*
Grafito	Cod. 970092	[PZ287]

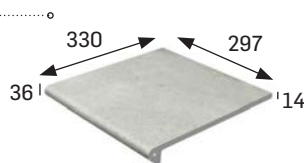

PELDAÑO REDONDEADO 120

ROUNDED STAIR-TREAD 120

Liso · Smooth
[1197x330x14 mm]

Blanco	Cod. 970035	[PZ724]
Gris	Cod. 970036	[PZ724]
Beige	Cod. 970037	[PZ724]
Caoba	Cod. 970183	[PZ724]
Grafito	Cod. 970170	[PZ724]

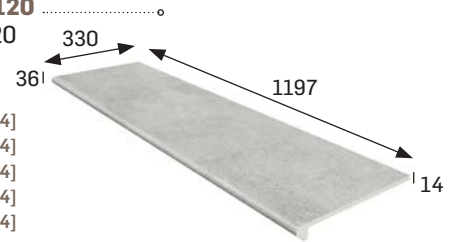

Liso · Smooth

Caoba	Cod. 970158	[PZ287]
--------------	-------------	---------

* Disponible bajo pedido. / Available on demand.

PELDAÑO RECTO 60

STRAIGHT STAIR-TREAD 60

Antideslizante · Anti slip
[597x315x14 mm]

Blanco	Cod. 970023	[PZ603]
Gris	Cod. 970024	[PZ603]
Beige	Cod. 970025	[PZ603]
Grafito	Cod. 970090	[PZ603]

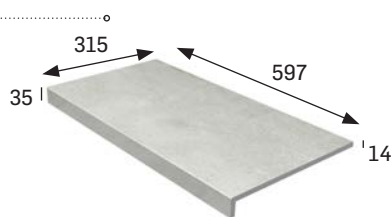

PELDAÑO RECTO 120

STRAIGHT STAIR-TREAD 120

Antideslizante · Anti slip
[1197x315x14 mm]

Blanco	Cod. 970095	[PZ724]
Gris	Cod. 970096	[PZ724]
Beige	Cod. 970097	[PZ724]
Grafito	Cod. 970091	[PZ724]

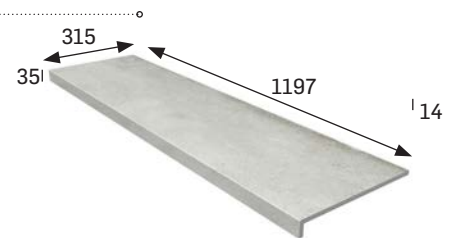

TAPA PELDAÑO REDONDA DCHA

RIGHT ROUNDED STEP COVER

[330x36 mm]

Blanco	Cod. 905239	[PZ190]
Gris	Cod. 905238	[PZ190]
Beige	Cod. 905241	[PZ190]
Caoba	Cod. 905642	[PZ190]
Grafito	Cod. 905240	[PZ190]

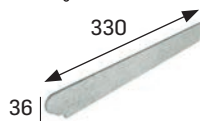

TAPA PELDAÑO REDONDA IZDA

LEFT ROUNDED STEP COVER

[330x36 mm]

Blanco	Cod. 905243	[PZ190]
Gris	Cod. 905242	[PZ190]
Beige	Cod. 905245	[PZ190]
Caoba	Cod. 905643	[PZ190]
Grafito	Cod. 905244	[PZ190]

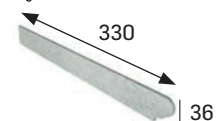

TAPA PELDAÑO RECTA

STRAIGHT STEP COVER

[315x35 mm]

Blanco	Cod. 905292	[PZ190]
Gris	Cod. 905291	[PZ190]
Beige	Cod. 905294	[PZ190]
Grafito	Cod. 905293	[PZ190]

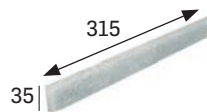

URBAN

PORCELÁNICOS
PORCELAIN TILES



Colores / Colors

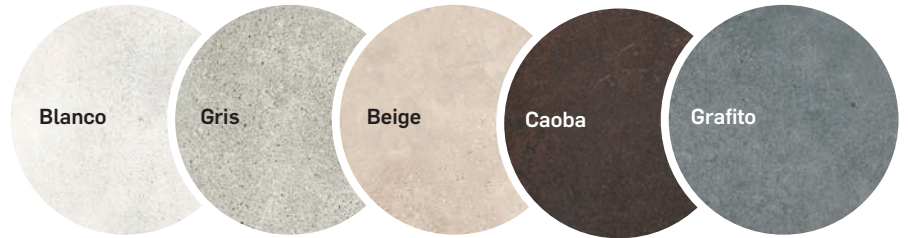

Urban Caoba 60x60

22

PAVIMENTOS FLOOR TILES

	Espeor (mm) Thickness (mm)	U.M.*	U.M./Caja U.M./Box	U.M./Palet U.M./Pallet	Pzs./U.M. Pcs./U.M.	Pzs./Caja Pcs./Box	Kg./U.M. Kg./U.M.	Kg./Caja Kg./Box	Kg./Palet Kg./Pallet
Rodapié 30 Skirting board 30	9,5	ml lm	10,21	367,57	3,33	34	1,74	17,6	650
Esquina redondeada Rounded stair-tread corner	14	Pz. Pc.	2	60	1	2	4,25	8,5	255
Zanquín redondeado izda. Rounded string left	9,5	Jg. set	5	300	2	10	0,85	4,25	255
Zanquín redondeado dcha. Rounded string right	9,5	Jg. set	5	300	2	10	0,85	4,25	255
Zanquín recto izda. Straight string left	9,5	Jg. set	5	300	2	10	0,85	4,25	255
Zanquín recto dcha. Straight string right	9,5	Jg. set	5	300	2	10	0,85	4,25	255

* Unidad de Medida. Los artículos medidos en m² o ml se sirven contando la junta normal entre piezas.
* Unit of Measure. Items measured in sqm or lm are delivered assuming average joint between pieces.

Anchura recomendada de la junta de colocación: Consultar pág. 15.
Recommended joint width: See pg. 15.

Piezas especiales Special pieces

ESQUINA REDONDEADA ROUNDED STAIR-TREAD CORNER

Antideslizante · Anti slip
[330x330x14 mm]

Blanco Cod. 904285 [PZ715]
Gris Cod. 904286 [PZ715]
Beige Cod. 904287 [PZ715]
Caoba Cod. 905647 [PZ715]*
Grafito Cod. 904774 [PZ715]

Liso · Smooth

Caoba Cod. 905777 [PZ715]

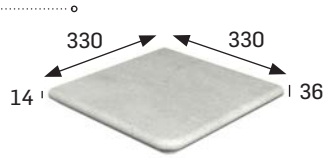

RODAPÍÉ 30 SKIRTING BOARD 30

Liso · Smooth
[297x80x9,5 mm]

Blanco Cod. 904305 [ML230]
Gris Cod. 904306 [ML230]
Beige Cod. 904307 [ML230]
Caoba Cod. 905646 [ML230]
Grafito Cod. 904779 [ML230]



* Disponible bajo pedido. / Available on demand.

ZANQUÍN REDONDEADO IZDA. ROUNDED STRING LEFT SIDE

Liso · Smooth
[293x80/273x9,5 mm]

Blanco Cod. 904289 [JG245]
Gris Cod. 904290 [JG245]
Beige Cod. 904291 [JG245]
Caoba Cod. 905644 [JG245]
Grafito Cod. 904775 [JG245]

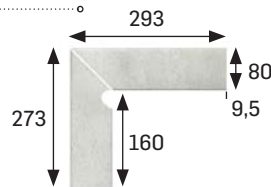

ZANQUÍN REDONDEADO DCHA. ROUNDED STRING RIGHT SIDE

Liso · Smooth
[293x80/273x9,5 mm]

Blanco Cod. 904293 [JG245]
Gris Cod. 904294 [JG245]
Beige Cod. 904295 [JG245]
Caoba Cod. 905645 [JG245]
Grafito Cod. 904776 [JG245]

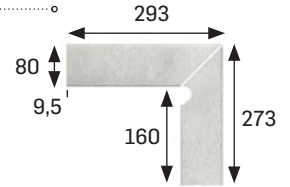

ZANQUÍN RECTO IZDA. STRAIGHT STRING LEFT SIDE

Liso · Smooth
[293x80/273x9,5 mm]

Blanco Cod. 904297 [JG245]
Gris Cod. 904298 [JG245]
Beige Cod. 904299 [JG245]
Grafito Cod. 904777 [JG245]

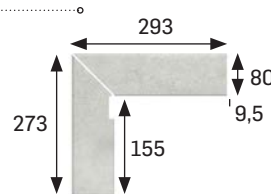

ZANQUÍN RECTO DCHA. STRAIGHT STRING RIGHT SIDE

Liso · Smooth
[293x80/273x9,5 mm]

Blanco Cod. 904301 [JG245]
Gris Cod. 904302 [JG245]
Beige Cod. 904303 [JG245]
Grafito Cod. 904778 [JG245]

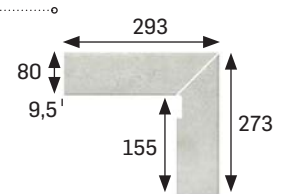

URBAN

PORCELÁNICOS
PORCELAIN TILES



Colores / Colors

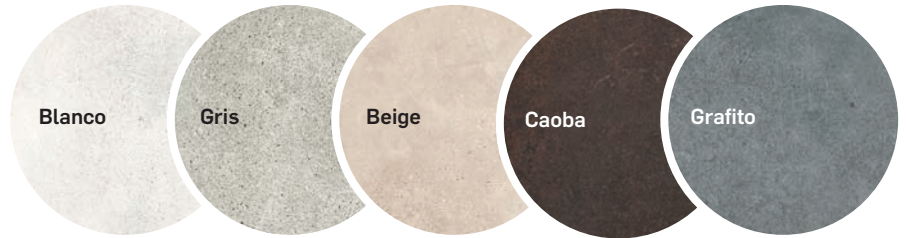

Urban Gris multiformato

		Espesor (mm) Thickness (mm)	U.M.*	U.M./Caja U.M./Box	U.M./Palet U.M./Pallet	Pzs./U.M. Pcs./U.M.	Pzs./Caja Pcs./Box	Kg./U.M.	Kg./Caja Kg./Box	Kg./Palet Kg./Pallet
Borde desbordante 60 Overflowing edge 60		25	Pz. Pc.	2	60	1	2	9,028	18,056	563
Esq. int. borde desbordante Overflowing internal edge		25	Jg. Set	2	-	2	4	7	14	-
Esq. ext. borde desbordante Overflowing external edge		25	Jg. Set	2	-	2	4	7	14	-
Rejilla monocompact ranurada Monocompact grooved grid		25	Pz. Pc.	5	315	1	5	4,2	20,8	1310
Esquina rejilla Corner grid		25	Set Set	1	-	1	2	7,96	7,96	-
Rejilla flexible ranurada Grooved Flexible grid		25	Pz. Pc.	1	30	1	1	12,7	12,7	381
Canaleta Overflow channel		30	Pz. Pc.	4	288	1	4	2,5	10,2	734
Cantonera External radial tile		-	Pz. Pc.	42	1512	1	42	0,34	14,5	522
Rinconera Internal radial tile		-	Pz. Pc.	35	1260	1	35	0,41	14,2	511
Esq. exterior cantonera External mitre		-	Pz. Pc.	4	-	1	4	0,33	1,3	-
Esq. interior rinconera Internal mitre		-	Pz. Pc.	4	-	1	4	0,33	1,3	-
Escocia cantonera exterior Round external mitre		-	Pz. Pc.	24	-	1	24	0,1	1,9	-
Escocia rinconera interior Round internal mitre		-	Pz. Pc.	24	-	1	24	0,1	1,9	-

* Unidad de Medida. Los artículos medidos en m² o ml se sirven contando la junta normal entre piezas.
* Unit of Measure. Items measured in sqm or lm are delivered assuming average joint between pieces.

Anchura recomendada de la junta de colocación: Consultar pág. 15.
Recommended joint width: See pg. 15.

Piezas especiales Special pieces

BORDE DESBORDANTE 60

OVERFLOWING EDGE 60

Antideslizante · Anti slip
[597x325x25 mm]

Blanco Cod. 904313 [PZ650]
Gris Cod. 904314 [PZ650]
Beige Cod. 904315 [PZ650]
Grafito Cod. 904781 [PZ650]

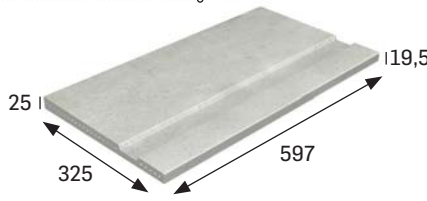

ESQ. INT. BORDE DESBORDANTE

OVERFLOWING INTERNAL EDGE

Antideslizante · Anti slip
[325x444x119 mm]

Blanco Cod. 904317 [JG762]
Gris Cod. 904318 [JG762]
Beige Cod. 904319 [JG762]
Grafito Cod. 904782 [JG762]

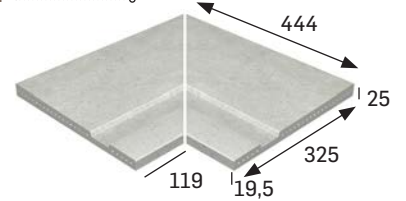

ESQ. EXT. BORDE DESBORDANTE

OVERFLOWING EXTERNAL EDGE

Antideslizante · Anti slip
[325x418x93 mm]

Blanco Cod. 904321 [JG762]
Gris Cod. 904322 [JG762]
Beige Cod. 904323 [JG762]
Grafito Cod. 904783 [JG762]

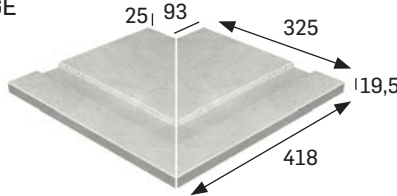

REJILLA MONOCOMPACT RANURADA

MONOCOMPACT GROOVED GRID

Antideslizante / Anti slip **
[291x244x25 mm]

Blanco Cod. 905056 [PZ595]
Gris Cod. 904909 [PZ595]
Beige Cod. 905058 [PZ595]
Grafito Cod. 905059 [PZ595]

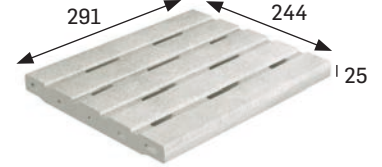

** En rejillas, los agujeros siempre deben ir paralelos al vaso para su mayor resistencia, con canal de 250 mm de ancho.

** Install the grids with the holes always parallel to the pool vessel to get a greater resistance, with a channel 250 mm wide

ESQUINA REJILLA

CORNER GRID

Antideslizante · Anti slip
[388x244x25 x144 mm]

Blanco Cod. 905052 [JG761]
Gris Cod. 905053 [JG761]
Beige Cod. 905054 [JG761]
Grafito Cod. 905055 [JG761]

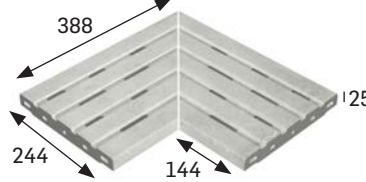

REJILLA FLEXIBLE RANURADA

GROOVED FLEXIBLE GRID *

Antideslizante · Anti slip
[245x25 x52 mm]

Blanco Cod. 905048 [ML780]
Gris Cod. 905049 [ML780]
Beige Cod. 905050 [ML780]
Grafito Cod. 905051 [ML780]

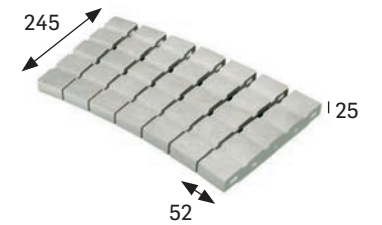

* Disponible bajo pedido. / Available on demand.
Ver/See pg. 14.

CANALETA*

OVERFLOW CHANNEL

Antideslizante · Anti slip
[297x244x30 mm]

Blanco Cod. 904337 [PZ382]
Gris Cod. 904338 [PZ382]
Beige Cod. 904339 [PZ382]
Grafito Cod. 904787 [PZ382]

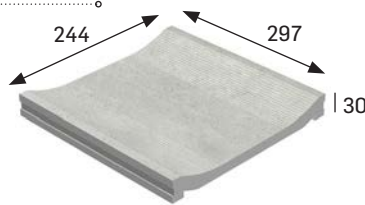

* Disponible Canaleta con desagüe.

* Overflow channel with drainage available.

CANTONERA

EXTERNAL RADIAL TILE

Antideslizante · Anti slip
[297x42 mm]

Blanco Cod. 904345 [PZ123]
Gris Cod. 904346 [PZ123]
Beige Cod. 904347 [PZ123]
Grafito Cod. 904790 [PZ123]



RINCONERA

INTERNAL RADIAL TILE

Antideslizante · Anti slip
[297x42 mm]

Blanco Cod. 904341 [PZ123]
Gris Cod. 904342 [PZ123]
Beige Cod. 904343 [PZ123]
Grafito Cod. 904789 [PZ123]



ESQ. EXT. CANTONERA

EXTERNAL MITRE

Antideslizante · Anti slip
[75x75 mm]

Blanco Cod. 904357 [PZ355]
Gris Cod. 904358 [PZ355]
Beige Cod. 904359 [PZ355]
Grafito Cod. 904794 [PZ355]

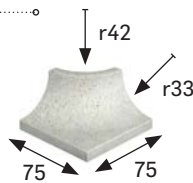

ESQ. INT. RINCONERA

INTERNAL MITRE

Antideslizante · Anti slip
[75x75 mm]

Blanco Cod. 904361 [PZ355]
Gris Cod. 904362 [PZ355]
Beige Cod. 904363 [PZ355]
Grafito Cod. 904793 [PZ355]

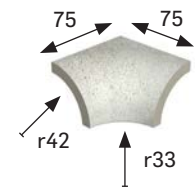

ESCOCIA CANTONERA EXTERIOR

ROUND EXTERNAL MITRE

Antideslizante · Anti slip

Blanco Cod. 904353 [PZ280]
Gris Cod. 904354 [PZ280]
Beige Cod. 904355 [PZ280]
Grafito Cod. 904792 [PZ280]



ESCOCIA RINCONERA INTERIOR

ROUND INTERNAL MITRE

Antideslizante · Anti slip

Blanco Cod. 904349 [PZ280]
Gris Cod. 904350 [PZ280]
Beige Cod. 904351 [PZ280]
Grafito Cod. 904791 [PZ280]

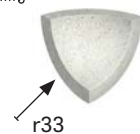

TIBET

PORCELÁNICOS PORCELAIN TILES



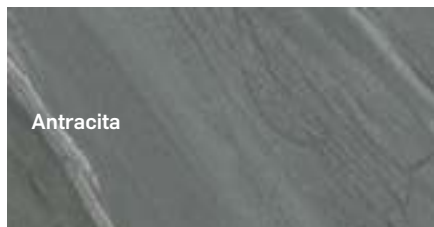





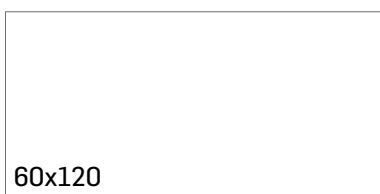
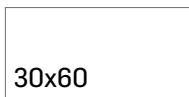







Colores / Colors



Los colores son indicativos.
Colors are just indicative.

(cm) Formatos / Sizes



	PORCELÁNICO PORCELAIN	
	ESMALTADO GLAZED	
	Características dimensionales Dimension tolerance	<1% / <0,6% máx 2 mm.
	Absorción de agua Water absorption	E≤0,5%
	Coef. Dilatación térmica lineal Linear thermal expansion coefficient	5,8x10 ⁻⁶ xC ⁻¹
	Resistencia a la flexión Breaking strength	>40N/mm ²
	Resistencia a la abrasión superficial Resistance to surface abrasion	Antideslizante / Anti slip <i>Gris, Beige, Blanco</i> PEI 4 <i>Antracita</i> PEI 3 Liso / Smooth <i>Gris, Beige, Blanco</i> PEI 4 <i>Antracita</i> PEI 3
	Resistencia a las manchas Resistance to stains	clase 5 class 5
	Péndulo (CTE) Not required out of Spain	Antideslizante clase 3 Anti slip class 3 Liso clase 1 Smooth class 1
	A pie descalzo Barefoot slip resistance	Antideslizante / Anti slip C Liso / Smooth A
	A pie calzado Slip resistance with footwear	Antideslizante / Anti slip R11 Liso / Smooth R9
	Resistencia al cuarteo Crazing resistance	sí/yes
	Resistencia a la helada Frost resistance	✓
	Resistencia al choque térmico Resistance to thermal shock	✓
	Resistencia química Chemical resistance	✓
	Destonificado Shade variation	V3 moderado mild
	Antibacteriano Antibacterian	R>2 Reducción antibacteriana >99 %



Tibet Blanco 60x120

TIBET

PORCELÁNICOS
PORCELAIN TILES



Colores / Colors

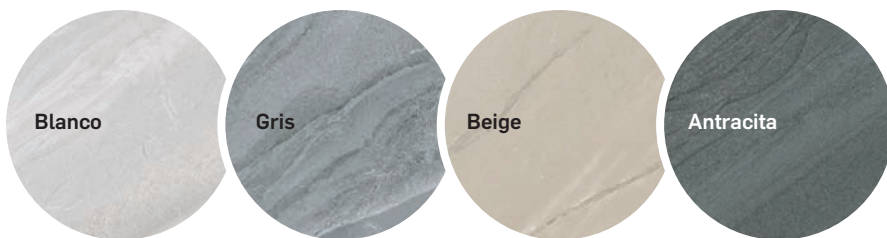

BASE 30x30 TILE 30x30

[297x297x10 mm]

Blanco Antideslizante / Anti slip Cod. 904911 [MC479]
Gris Antideslizante / Anti slip Cod. 904912 [MC479]
Beige Antideslizante / Anti slip Cod. 904913 [MC479]
Antracita Antideslizante / Anti slip Cod. 904914 [MC479]

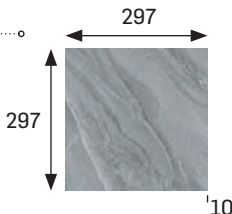

BASE 30x60 TILE 30x60

[297x597x10 mm]

Blanco Antideslizante / Anti slip Cod. 904919 [MC479]
Gris Antideslizante / Anti slip Cod. 904920 [MC479]
Beige Antideslizante / Anti slip Cod. 904921 [MC479]
Antracita Antideslizante / Anti slip Cod. 904922 [MC479]

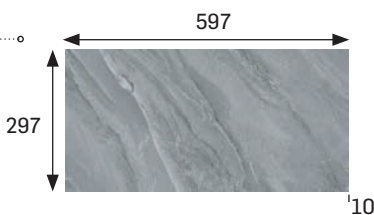

BASE 60x120** TILE 60x120**

[600x1200x10,4 mm]

Blanco Antideslizante / Anti slip Cod. 905247 [MC567]
Gris Antideslizante / Anti slip Cod. 905246 [MC567]
Beige Antideslizante / Anti slip Cod. 905248 [MC567]
Antracita Antideslizante / Anti slip Cod. 905249 [MC567]

Blanco Liso / Smooth Cod. 904931 [MC567]
Gris Liso / Smooth Cod. 904932 [MC567]
Beige Liso / Smooth Cod. 904933 [MC567]
Antracita Liso / Smooth Cod. 904934 [MC567]

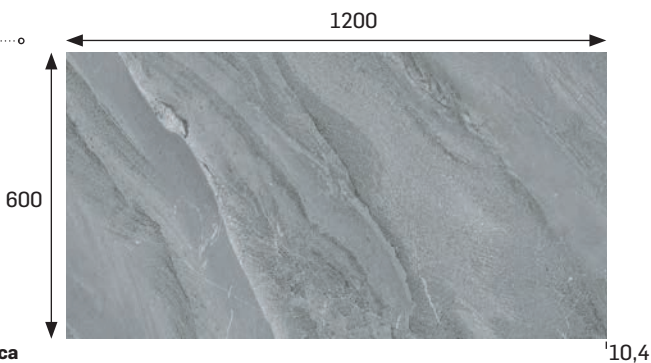

** Producto disponible bajo pedido. Consultar plazos de entrega con fábrica

** Product available under demand. Ask for delivery terms to factory.

	Espesor (mm) Thickness (mm)	U.M.*	U.M./Caja U.M./Box	U.M./Palet U.M./Pallet	Pzs./U.M. Pcs./U.M.	Pzs./Caja Pcs./Box	Kg./U.M. Kg./U.M.	Kg./Caja Kg./Box	Kg./Palet Kg./Pallet
Base 30x30 Tile 30x30	10	m ² sqm	0,99	71,29	11,11	11	21,54	21,33	1536
Base 30x60 Tile 30x60	10	m ² sqm	1,08	64,86	5,55	6	21,65	23,38	1403
Base 60x120 Tile 60x120	10,4	m ² sqm	1,45	43,5	1,37	2	25,08	34,6	1017

* Unidad de Medida. Los artículos medidos en m² o ml se sirven contando la junta normal entre piezas.

* Unit of Measure. Items measured in sqm or lm are delivered assuming average joint between pieces.

Anchura recomendada de la junta de colocación: Consultar pág. 15.

Recommended joint width: See pg. 15.



Tibet Blanco 60x120

TIBET

PORCELÁNICOS
PORCELAIN TILES



Colores / Colors

Blanco

Gris

Beige

Antracita



Tibet Antracita 30x30

30

PAVIMENTOS FLOOR TILES

	Espesor (mm) Thickness (mm)	U.M.*	U.M./Caja U.M./Box	U.M./Palet U.M./Pallet	Pzs./U.M. Pcs./U.M.	Pzs./Caja Pcs./Box	Kg./U.M. Kg./U.M.	Kg./Caja Kg./Box	Kg./Palet Kg./Pallet
Peldaño redondeado 120 Rounded stair-tread 120	14	Pz. Pc.	2	32	1	2	12,1	24,2	387,2
Peldaño recto 30 Straight stair-tread 30	14	Pz. Pc.	4	288	1	4	2,76	11,05	795,5
Peldaño recto 120 Straight stair-tread 120	14	Pz. Pc.	2	32	1	2	11,32	22,6	362,2
Tapa peldaño redonda dcha. Right rounded step cover	-	Pz. Pc.	10	**	1	10	0,17	1,7	**
Tapa peldaño redonda izda. Left rounded step cover	-	Pz. Pc.	10	**	1	10	0,17	1,7	**
Tapa peldaño recta Straight step cover	-	Pz. Pc.	10	**	1	10	0,17	1,7	**

* Unidad de Medida. Los artículos medidos en m² o ml se sirven contando la junta normal entre piezas.

* Unit of Measure. Items measured in sqm or lm are delivered assuming average joint between pieces.

Anchura recomendada de la junta de colocación: Consultar pág. 15.

Recommended joint width: See pg. 15.

** Consultar datos de embalaje con fábrica / ** Ask for packing information to the factory

Piezas especiales Special pieces

PELDAÑO REDONDEADO 120

ROUNDED STAIR-TREAD 120

Liso · Smooth

[1197x330x14 mm]

Blanco Cod. 970171 [PZ724]
Gris Cod. 970163 [PZ724]
Beige Cod. 970162 [PZ724]
Antracita Cod. 970172 [PZ724]

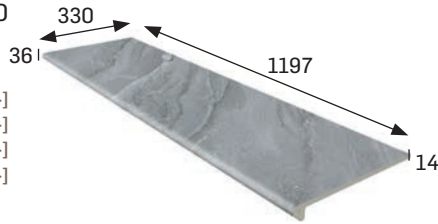

PELDAÑO RECTO 30

STRAIGHT STAIR-TREAD 30

Antideslizante · Anti slip

[297x315x14 mm]

Blanco Cod. 970119 [PZ287]
Gris Cod. 970120 [PZ287]
Beige Cod. 970121 [PZ287]
Antracita Cod. 970122 [PZ287]

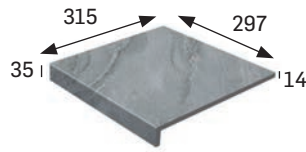

PELDAÑO RECTO 120

STRAIGHT STAIR-TREAD 120

Antideslizante · Anti slip

[1197x315x14 mm]

Blanco Cod. 970127 [PZ724]
Gris Cod. 970128 [PZ724]
Beige Cod. 970129 [PZ724]
Antracita Cod. 970130 [PZ724]

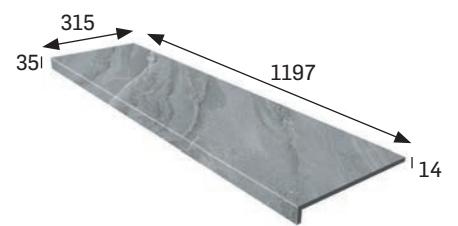

TAPA PELDAÑO REDONDA DCHA

RIGHT ROUNDED STEP COVER

[330x36 mm]

Blanco Cod. 905255 [PZ190]
Gris Cod. 905254 [PZ190]
Beige Cod. 905256 [PZ190]
Antracita Cod. 905257 [PZ190]

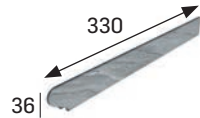

TAPA PELDAÑO REDONDA IZDA

LEFT ROUNDED STEP COVER

[330x36 mm]

Blanco Cod. 905259 [PZ190]
Gris Cod. 905258 [PZ190]
Beige Cod. 905260 [PZ190]
Antracita Cod. 905261 [PZ190]

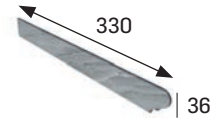

TAPA PELDAÑO RECTA

STRAIGHT STEP COVER

[315x35 mm]

Blanco Cod. 905300 [PZ190]
Gris Cod. 905299 [PZ190]
Beige Cod. 905301 [PZ190]
Antracita Cod. 905302 [PZ190]

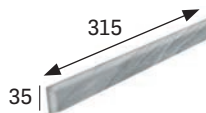

TIBET

PORCELÁNICOS
PORCELAIN TILES



Colores / Colors



Blanco

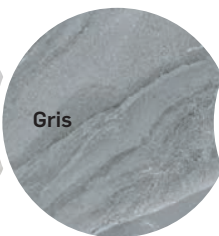

Gris



Beige

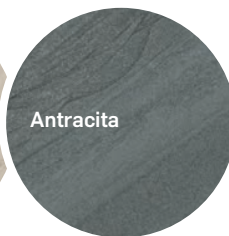

Antracita



Tibet Beige 60x120

	Espesor (mm) Thickness (mm)	U.M.*	U.M./Caja U.M./Box	U.M./Palet U.M./Pallet	Pzs./U.M. Pcs./U.M.	Pzs./Caja Pcs./Box	Kg./U.M. Kg./U.M.	Kg./Caja Kg./Box	Kg./Palet Kg./Pallet
Tabica 15x120 Riser 15x120	10,4	Pz. Pc.	6	264	1	6	4,24	25,4	1119
Rodapié 30 Skirting board 30	9,5	ml lm	10,21	367,57	3,33	34	1,74	17,6	650
Esquina recta Straight stair-tread corner	14	Pz. Pc.	2	60	1	2	3,5	7	420
Zanquín redondeado izda. Rounded string left	9,5	Jg. set	5	300	2	10	0,85	4,25	255
Zanquín redondeado dcha. Rounded string right	9,5	Jg. set	5	300	2	10	0,85	4,25	255
Zanquín recto izda. Straight string left	9,5	Jg. set	5	300	2	10	0,85	4,25	255
Zanquín recto dcha. Straight string right	9,5	Jg. set	5	300	2	10	0,85	4,25	255

* Unidad de Medida. Los artículos medidos en m² o ml se sirven contando la junta normal entre piezas.
* Unit of Measure. Items measured in sqm or lm are delivered assuming average joint between pieces.

Anchura recomendada de la junta de colocación: Consultar pág. 15.
Recommended joint width: See pg. 15.

Piezas especiales Special pieces

TABICA 15X120

RISER 15x120

Liso · Smooth

[147x1197x10,4 mm]

Blanco Cod. 904935 [PZ220]
Gris Cod. 904936 [PZ220]
Beige Cod. 904937 [PZ220]
Antracita Cod. 904938 [PZ220]

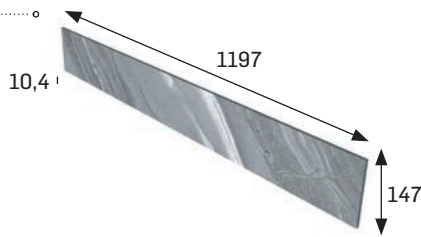

RODAPÍE 30

SKIRTING BOARD 30

Liso · Smooth

[297x80x9,5 mm]

Blanco Cod. 904979 [ML230]
Gris Cod. 904980 [ML230]
Beige Cod. 904981 [ML230]
Antracita Cod. 904982 [ML230]

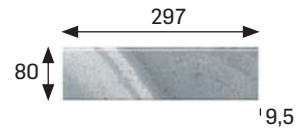

ESQUINA RECTA

STRAIGHT STAIR-TREAD CORNER

Antideslizante · Anti slip

[315x315x40x14 mm]

Blanco Cod. 904951 [PZ715]
Gris Cod. 904952 [PZ715]
Beige Cod. 904953 [PZ715]
Antracita Cod. 904954 [PZ715]

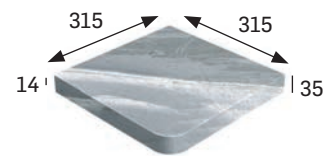

ZANQUÍN REDONDEADO IZDA.

ROUNDED STRING LEFT SIDE

Liso · Smooth

[293x80/273x9,5 mm]

Blanco Cod. 904963 [JG245]
Gris Cod. 904964 [JG245]
Beige Cod. 904965 [JG245]
Antracita Cod. 904966 [JG245]

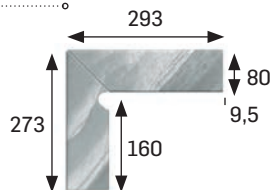

ZANQUÍN REDONDEADO DCHA.

ROUNDED STRING RIGHT SIDE

Liso · Smooth

[293x80/273x9,5 mm]

Blanco Cod. 904967 [JG245]
Gris Cod. 904968 [JG245]
Beige Cod. 904969 [JG245]
Antracita Cod. 904970 [JG245]

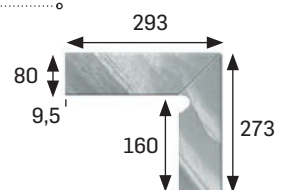

ZANQUÍN RECTO IZDA.

STRAIGHT STRING LEFT SIDE

Liso · Smooth

[293x80/273x9,5 mm]

Blanco Cod. 904971 [JG245]
Gris Cod. 904972 [JG245]
Beige Cod. 904973 [JG245]
Antracita Cod. 904974 [JG245]

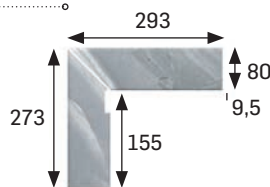

ZANQUÍN RECTO DCHA.

STRAIGHT STRING RIGHT SIDE

Liso · Smooth

[293x80/273x9,5 mm]

Blanco Cod. 904975 [JG245]
Gris Cod. 904976 [JG245]
Beige Cod. 904977 [JG245]
Antracita Cod. 904978 [JG245]

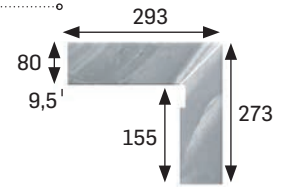

TIBET

PORCELÁNICOS
PORCELAIN TILES



Colores / Colors

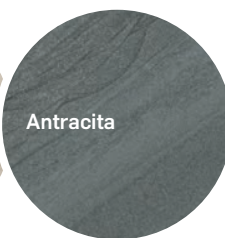
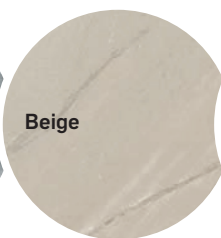
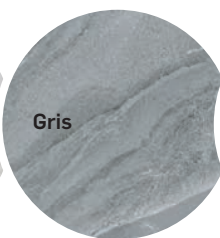

Tibet Gris 30x60

	Espe ^s or (mm) Thick ⁿ ess (mm)	U.M.*	U.M./Caja U.M./Box	U.M./Palet U.M./Pallet	Pzs./U.M. Pcs./U.M.	Pzs./Caja Pcs./Box	Kg./U.M. Kg./U.M.	Kg./Caja Kg./Box	Kg./Palet Kg./Pallet
Borde desbordante 60 Overflowing edge 60	25	Pz. Pc.	2	60	1	2	9,028	18,056	563
Esq. int. borde desbordante Overflowing internal edge	25	Jg. Set	2	-	2	4	7	14	-
Esq. ext. borde desbordante Overflowing external edge	25	Jg. Set	2	-	2	4	7	14	-
Rejilla monocompact ranurada Monocompact grooved grid	25	Pz. Pc.	5	315	1	5	4,2	20,8	1310
Esquina rejilla Corner grid	25	Set Set	1	-	1	2	7,96	7,96	-
Rejilla flexible ranurada Grooved Flexible grid	25	Pz. Pc.	1	30	1	1	12,7	12,7	381
Canaleta Overflow channel	30	Pz. Pc.	4	288	1	4	2,5	10,2	734
Cantonera External radial tile	-	Pz. Pc.	42	1512	1	42	0,34	14,5	522
Rinconera Internal radial tile	-	Pz. Pc.	35	1260	1	35	0,41	14,2	511
Esq. exterior cantonera External mitre	-	Pz. Pc.	4	-	1	4	0,33	1,3	-
Esq. interior rinconera Internal mitre	-	Pz. Pc.	4	-	1	4	0,33	1,3	-
Escocia cantonera exterior Round external mitre	-	Pz. Pc.	24	-	1	24	0,1	1,9	-
Escocia rinconera interior Round internal mitre	-	Pz. Pc.	24	-	1	24	0,1	1,9	-

* Unidad de Medida. Los artículos medidos en m² o ml se sirven contando la junta normal entre piezas.
* Unit of Measure. Items measured in sqm or lm are delivered assuming average joint between pieces.

Anchura recomendada de la junta de colocación: Consultar pág. 15.
Recommended joint width: See pg. 15.

Piezas especiales Special pieces

BORDE DESBORDANTE 60

OVERFLOWING EDGE 60

Antideslizante · Anti slip
[597x325x25 mm]

Blanco Cod. 904983 [PZ650]
Gris Cod. 904984 [PZ650]
Beige Cod. 904985 [PZ650]

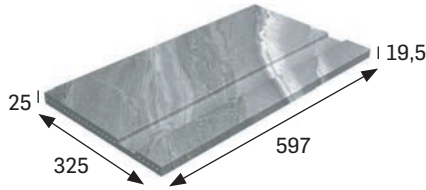

ESQ. INT. BORDE DESBORDANTE

OVERFLOWING INTERNAL EDGE

Antideslizante · Anti slip
[325x444x119 mm]

Blanco Cod. 904987 [JG762]
Gris Cod. 904988 [JG762]
Beige Cod. 904989 [JG762]

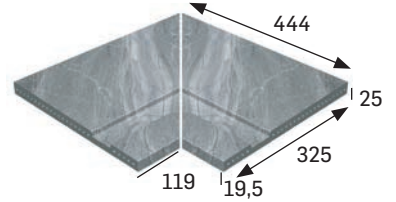

ESQ. EXT. BORDE DESBORDANTE

OVERFLOWING EXTERNAL EDGE

Antideslizante · Anti slip
[325x418x93 mm]

Blanco Cod. 904991 [JG762]
Gris Cod. 904992 [JG762]
Beige Cod. 904993 [JG762]

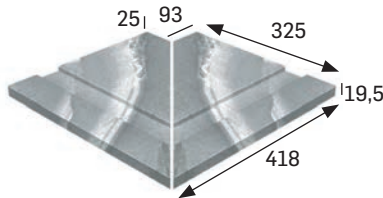

REJILLA MONOCOMPACT RANURADA

MONOCOMPACT GROOVED GRID

Antideslizante / Anti slip **
[291x244x25 mm]

Blanco Cod. 904995 [PZ595]
Gris Cod. 904996 [PZ595]
Beige Cod. 904997 [PZ595]

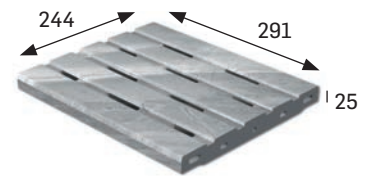

** En rejillas, los agujeros siempre deben ir paralelos al vaso para su mayor resistencia, con canal de 250 mm de ancho.

** Install the grids with the holes always parallel to the pool vessel to get a greater resistance, with a channel 250 mm wide

ESQUINA REJILLA

CORNER GRID

Antideslizante · Anti slip
[388x244x25 x144 mm]

Blanco Cod. 904999 [JG761]
Gris Cod. 905000 [JG761]
Beige Cod. 905001 [JG761]

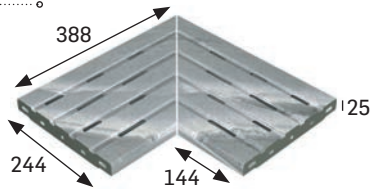

REJILLA FLEXIBLE RANURADA

GROOVED FLEXIBLE GRID *

Antideslizante · Anti slip
[245x25 x52 mm]

Blanco Cod. 905003 [ML780]
Gris Cod. 905004 [ML780]
Beige Cod. 905005 [ML780]

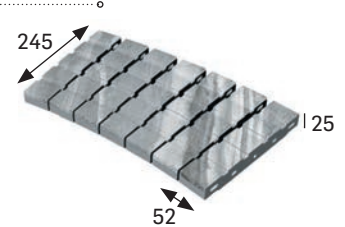

* Disponible bajo pedido. / Available on demand.

Ver/See pg. 14.

CANALETA*

OVERFLOW CHANNEL

Antideslizante · Anti slip
[297x244x30 mm]

Blanco Cod. 905007 [PZ382]
Gris Cod. 905008 [PZ382]
Beige Cod. 905009 [PZ382]

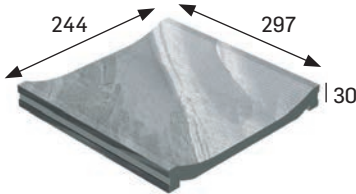

* Disponible Canaleta con desagüe.

* Overflow channel with drainage available.

CANTONERA

EXTERNAL RADIAL TILE

Antideslizante · Anti slip
[297x42 mm]

Blanco Cod. 905015 [PZ123]
Gris Cod. 905016 [PZ123]
Beige Cod. 905017 [PZ123]

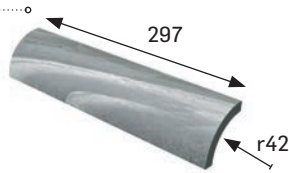

RINCONERA

INTERNAL RADIAL TILE

Antideslizante · Anti slip
[297x42 mm]

Blanco Cod. 905011 [PZ123]
Gris Cod. 905012 [PZ123]
Beige Cod. 905013 [PZ123]



ESQ. EXT. CANTONERA

EXTERNAL MITRE

Antideslizante · Anti slip
[75x75 mm]

Blanco Cod. 905031 [PZ355]
Gris Cod. 905032 [PZ355]
Beige Cod. 905033 [PZ355]

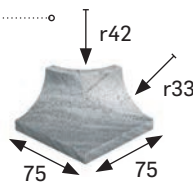

ESQ. INT. RINCONERA

INTERNAL MITRE

Antideslizante · Anti slip
[75x75 mm]

Blanco Cod. 905027 [PZ355]
Gris Cod. 905028 [PZ355]
Beige Cod. 905029 [PZ355]

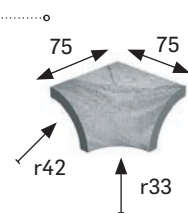

ESCOCIA CANTONERA EXTERIOR

ROUND EXTERNAL MITRE

Antideslizante · Anti slip

Blanco Cod. 905023 [PZ280]
Gris Cod. 905024 [PZ280]
Beige Cod. 905025 [PZ280]



ESCOCIA RINCONERA INTERIOR

ROUND INTERNAL MITRE

Antideslizante · Anti slip

Blanco Cod. 905019 [PZ280]
Gris Cod. 905020 [PZ280]
Beige Cod. 905021 [PZ280]

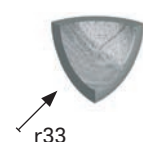

MARBLE

PORCELÁNICOS PORCELAIN TILES

Colores / Colors

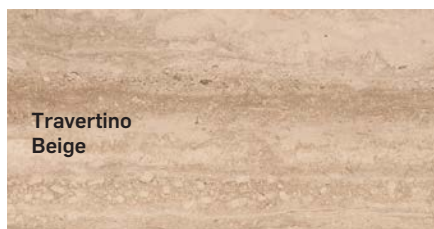
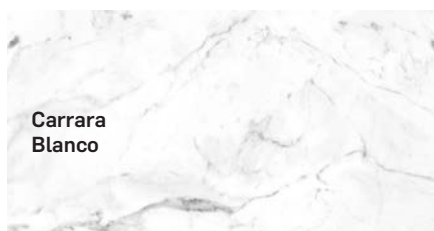





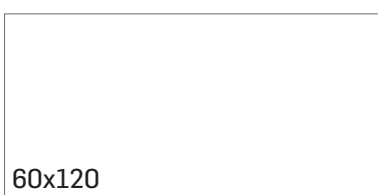
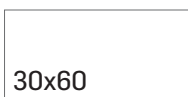





Los colores son indicativos.
Colors are just indicative.

(cm) Formatos / Sizes



36

PAVIMENTOS FLOOR TILES

	PORCELÁNICO PORCELAIN	
	ESMALTADO GLAZED	
	Características dimensionales Dimension tolerance	<1% / <0,6% máx 2 mm.
	Absorción de agua Water absorption	E≤0,5%
	Coef. Dilatación térmica lineal Linear thermal expansion coefficient	5,8x10 ⁻⁶ xC ⁻¹
	Resistencia a la flexión Breaking strength	>40N/mm ²
	Resistencia a la abrasión superficial Resistance to surface abrasion	PEI 4
	Resistencia a las manchas Resistance to stains	clase 5 class 5
	Péndulo (CTE) Not required out of Spain	Antideslizante clase 3 Anti slip class 3 Liso clase 1 Smooth class 1
	A pie descalzo Barefoot slip resistance	Antideslizante / Anti slip C Liso / Smooth A
	A pie calzado Slip resistance with footwear	Antideslizante / Anti slip R11 Liso / Smooth R9
	Resistencia al cuarteo Crazing resistance	sí/yes
	Resistencia a la helada Frost resistance	✓
	Resistencia al choque térmico Resistance to thermal shock	✓
	Resistencia química Chemical resistance	✓
	Destonificado Shade variation	V3 moderado mild
	Antibacteriano Antibacterian	R>2 Reducción antibacteriana >99 %



Marble Carrara 30x60 · Peldaño recto 120 / Straight stair-tread 120

MARBLE

PORCELÁNICOS
PORCELAIN TILES



Colores / Colors



BASE 30x60 TILE 30x60

[297x597x10 mm]

Carrara Blanco Antideslizante / Anti slip Cod. 905537 [MC479]
Travertino Beige Antideslizante / Anti slip Cod. 905538 [MC479]



BASE 60x120** TILE 60x120**

[600x1200x10,4 mm]

Carrara Blanco Antideslizante / Anti slip Cod. 905539 [MC567]
Travertino Beige Antideslizante / Anti slip Cod. 905540 [MC567]

Carrara Blanco Liso / Smooth Cod. 905541 [MC567]
Travertino Beige Liso / Smooth Cod. 905542 [MC567]



** Producto disponible bajo pedido. Consultar plazos de entrega con fábrica
** Product available under demand. Ask for delivery terms to factory.

	Espesor (mm) Thickness (mm)	U.M.*	U.M./Caja U.M./Box	U.M./Palet U.M./Pallet	Pzs./U.M. Pcs./U.M.	Pzs./Caja Pcs./Box	Kg./U.M. Kg./U.M.	Kg./Caja Kg./Box	Kg./Palet Kg./Pallet
Base 30x60 Tile 30x60	10	m ² sqm	1,08	64,86	5,55	6	21,65	23,38	1403
Base 60x120 Tile 60x120	10,4	m ² sqm	1,45	43,5	1,37	2	25,08	34,6	1017

* Unidad de Medida. Los artículos medidos en m² o ml se sirven contando la junta normal entre piezas.
* Unit of Measure. Items measured in sqm or lm are delivered assuming average joint between pieces.

Anchura recomendada de la junta de colocación: Consultar pág. 15.
Recommended joint width: See pg. 15.



Marble Travertino 60x120



Marble Carrara 60x120

MARBLE

PORCELÁNICOS
PORCELAIN TILES



Colores / Colors

Carrara
Blanco

Travertino
Beige



Marble Travertino 30x60

	Espesor (mm) Thickness (mm)	U.M.*	U.M./Caja U.M./Box	U.M./Palet U.M./Pallet	Pzs./U.M. Pcs./U.M.	Pzs./Caja Pcs./Box	Kg./U.M. Kg./U.M.	Kg./Caja Kg./Box	Kg./Palet Kg./Pallet
Tabica 15x120 Riser 15x120	10,4	Pz. Pc.	6	264	1	6	4,24	25,4	1119
Rodapié 30 Skirting board 30	9,5	ml lm	10,21	367,57	3,33	34	1,74	17,6	650
Peldaño redondeado 120 Rounded stair-tread 120	14	Pz. Pc.	2	32	1	2	12,1	24,2	387,2
Peldaño recto 120 Straight stair-tread 120	14	Pz. Pc.	2	32	1	2	11,32	22,6	362,2
Zanquín redondeado izda. Rounded string left	9,5	Jg. set	5	300	2	10	0,85	4,25	255
Zanquín redondeado dcha. Rounded string right	9,5	Jg. set	5	300	2	10	0,85	4,25	255
Zanquín recto izda. Straight string left	9,5	Jg. set	5	300	2	10	0,85	4,25	255
Zanquín recto dcha. Straight string right	9,5	Jg. set	5	300	2	10	0,85	4,25	255
Tapa peldaño redonda dcha. Right rounded step cover	-	Pz. Pc.	10	**	1	10	0,17	1,7	**
Tapa peldaño redonda izda. Left rounded step cover	-	Pz. Pc.	10	**	1	10	0,17	1,7	**
Tapa peldaño recta Straight step cover	-	Pz. Pc.	10	**	1	10	0,17	1,7	**

* Unidad de Medida. Los artículos medidos en m² o ml se sirven contando la junta normal entre piezas.

* Unit of Measure. Items measured in sqm or lm are delivered assuming average joint between pieces.

Anchura recomendada de la junta de colocación: Consultar pág. 15.

Recommended joint width: See pg. 15.

** Consultar datos de embalaje con fábrica / ** Ask for packing information to the factory

Piezas especiales Special pieces

TABICA 15X120

RISER 15x120

Liso · Smooth
[147x1197x10,4 mm]

Carrara Blanco Cod. 905543 [PZ220]
Travertino Beige Cod. 905544 [PZ220]



RODAPIÉ 30

SKIRTING BOARD 30

Liso · Smooth
[297x80x9,5 mm]

Carrara Blanco Cod. 905549 [ML230]
Travertino Beige Cod. 905550 [ML230]



PELDAÑO REDONDEADO 120

ROUNDED STAIR-TREAD 120

Liso · Smooth
[1197x330x14 mm]

Carrara Blanco Cod. 970180 [PZ724]
Travertino Beige Cod. 970181 [PZ724]

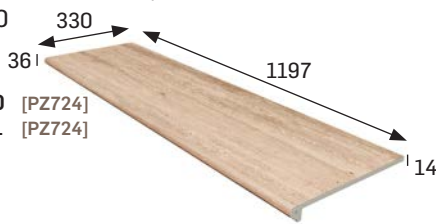

PELDAÑO RECTO 120

STRAIGHT STAIR-TREAD 120

Antideslizante · Anti slip
[1197x315x14 mm]

Carrara Blanco Cod. 970178 [PZ724]
Travertino Beige Cod. 970179 [PZ724]

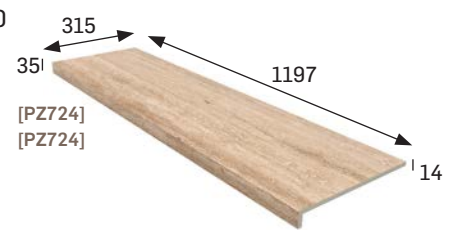

ZANQUÍN REDONDEADO IZDA.

ROUNDED STRING LEFT SIDE

Liso · Smooth
[293x80/273x9,5 mm]

Carrara Blanco Cod. 905555 [JG245]
Travertino Beige Cod. 905557 [JG245]

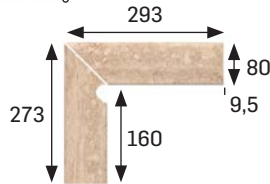

ZANQUÍN REDONDEADO DCHA.

ROUNDED STRING RIGHT SIDE

Liso · Smooth
[293x80/273x9,5 mm]

Carrara Blanco Cod. 905556 [JG245]
Travertino Beige Cod. 905558 [JG245]

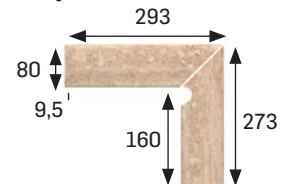

ZANQUÍN RECTO IZDA.

STRAIGHT STRING LEFT SIDE

Liso · Smooth
[293x80/273x9,5 mm]

Carrara Blanco Cod. 905551 [JG245]
Travertino Beige Cod. 905553 [JG245]

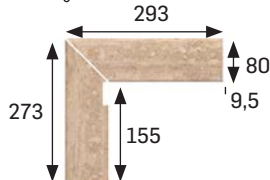

ZANQUÍN RECTO DCHA.

STRAIGHT STRING RIGHT SIDE

Liso · Smooth
[293x80/273x9,5 mm]

Carrara Blanco Cod. 905552 [JG245]
Travertino Beige Cod. 905554 [JG245]

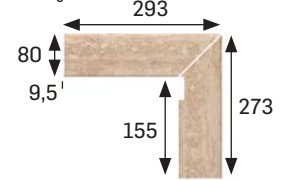

TAPA PELDAÑO REDONDA DCHA.

RIGHT ROUNDED STEP COVER

[330x36 mm]

Carrara Blanco Cod. 905559 [PZ190]
Travertino Beige Cod. 905561 [PZ190]



TAPA PELDAÑO REDONDA IZDA.

LEFT ROUNDED STEP COVER

[330x36 mm]

Carrara Blanco Cod. 905560 [PZ190]
Travertino Beige Cod. 905562 [PZ190]



TAPA PELDAÑO RECTA

STRAIGHT STEP COVER

[315x35 mm]

Carrara Blanco Cod. 905563 [PZ190]
Travertino Beige Cod. 905564 [PZ190]



ORDESA

PORCELÁNICOS PORCELAIN TILES

Colores / Colors



Los colores son indicativos.
Colors are just indicative.

















(cm) Formatos / Sizes

15x60

20x120

42

PAVIMENTOS FLOOR TILES

	PORCELÁNICO PORCELAIN	
	ESMALTADO GLAZED	
	Características dimensionales Dimension tolerance	<1% / <0,6% máx 2 mm.
	Absorción de agua Water absorption	E≤0,5%
	Expansión por humedad Moisture expansion	<0,1 mm/m
	Resistencia a la flexión Breaking strength	40N/mm ²
	Resistencia a la abrasión superficial Resistance to surface abrasion	PEI 4
	Resistencia a las manchas Resistance to stains	clase 5 class 5
	Péndulo (CTE) Not required out of Spain	Antideslizante clase 3 Anti slip class 3 Liso clase 1 Smooth class 1
	A pie descalzo Barefoot slip resistance	Antideslizante C Anti slip C Liso A Smooth A
	A pie calzado Slip resistance with footwear	Antideslizante R11 Anti slip R11 Liso R9 Smooth R9
	Resistencia al cuarteo Crazing resistance	sí/yes
	Resistencia a la helada Frost resistance	✓
	Resistencia al choque térmico Resistance to thermal shock	✓
	Resistencia química Chemical resistance	✓
	Destonificado Shade variation	V3 moderado mild
	Antibacteriano Antibacterian	R>2 Reducción antibacteriana >99 %



Ordesa Marrón 15x60



BASE 15x60 TILE 15x60

[147x597x10 mm]

Gris Antideslizante / Anti slip	Cod. 904623	[MC520]
Beige Antideslizante / Anti slip	Cod. 904624	[MC520]
Natural Antideslizante / Anti slip	Cod. 905506	[MC520]
Marrón Antideslizante / Anti slip	Cod. 904625	[MC520]



BASE 20x120 TILE 20x120

[195x1200x10,4 mm]

rectificada/rectified

Gris Antideslizante / Anti slip	Cod. 904715	[MC567]
Beige Antideslizante / Anti slip	Cod. 904716	[MC567]
Natural Antideslizante / Anti slip	Cod. 905480	[MC567]
Marrón Antideslizante / Anti slip	Cod. 904717	[MC567]



Gris Liso / Smooth	Cod. 905159	[MC567]
Beige Liso / Smooth	Cod. 905160	[MC567]
Natural Liso / Smooth	Cod. 905507	[MC567]
Marrón Liso / Smooth	Cod. 905161	[MC567]

	Espeor (mm) Thickness (mm)	U.M.*	U.M./Caja U.M./Box	U.M./Palet U.M./Pallet	Pzs./U.M. Pcs./U.M.	Pzs./Caja Pcs./Box	Kg./U.M. Kg./U.M.	Kg./Caja Kg./Box	Kg./Palet Kg./Pallet
Base 15x60 Tile 15x60	10	m ² sqm	0,99	71,29	11,11	11	21,54	21,33	1536
Base 20x120 Tile 20x120	10,4	m ² sqm	0,95	45,73	4,2	4	23,41	22,2	1060



Ordesa Beige 20x120

ORDESA

PORCELÁNICOS
PORCELAIN TILES



Colores / Colors



Ordesa Natural 20x120

	Espeor (mm) Thickness (mm)	U.M.*	U.M./Caja U.M./Box	U.M./Palet U.M./Pallet	Pzs./U.M. Pcs./U.M.	Pzs./Caja Pcs./Box	Kg./U.M. Kg./U.M.	Kg./Caja Kg./Box	Kg./Palet Kg./Pallet
Peldaño redondeado 120 Rounded stair-tread 120	14	Pz. Pc.	2	32	1	2	12,1	24,2	387,2
Peldaño recto 60 Straight stair-tread 60	14	Pz. Pc.	4	144	1	4	5,8	23,4	842
Peldaño recto 120 Straight stair-tread 120	14	Pz. Pc.	2	32	1	2	11,32	22,6	362,2
Tapa peldaño redonda dcha. Right rounded step cover	-	Pz. Pc.	10	**	1	10	0,17	1,7	**
Tapa peldaño redonda izda. Left rounded step cover	-	Pz. Pc.	10	**	1	10	0,17	1,7	**
Tapa peldaño recta Straight step cover	-	Pz. Pc.	10	**	1	10	0,17	1,7	**

* Unidad de Medida. Los artículos medidos en m² o ml se sirven contando la junta normal entre piezas.
* Unit of Measure. Items measured in sqm or lm are delivered assuming average joint between pieces.

Anchura recomendada de la junta de colocación: Consultar pág. 15.
Recommended joint width: See pg. 15.

** Consultar datos de embalaje con fábrica / ** Ask for packing information to the factory

Piezas especiales Special pieces

PELDAÑO REDONDEADO 120

ROUNDED STAIR-TREAD 120

Liso · Smooth

[1197x330x14 mm]

Gris Cod. 970164 [PZ724]
Beige Cod. 970165 [PZ724]
Natural Cod. 970177 [PZ724]
Marrón Cod. 970173 [PZ724]

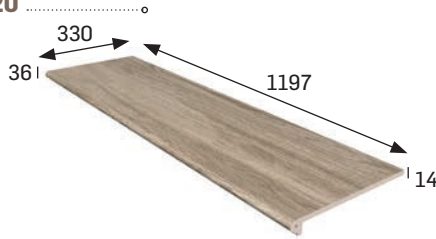

PELDAÑO RECTO 60

STRAIGHT STAIR-TREAD 60

Antideslizante · Anti slip

[597x315x14 mm]

Gris Cod. 970064 [PZ603]
Beige Cod. 970065 [PZ603]
Natural Cod. 970175 [PZ603]
Marrón Cod. 970066 [PZ603]

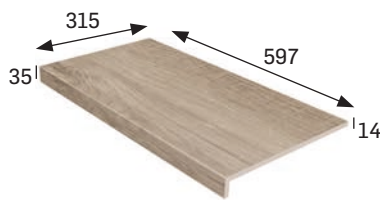

PELDAÑO RECTO 120

STRAIGHT STAIR-TREAD 120

Antideslizante · Anti slip

[1197x315x14 mm]

Gris Cod. 970067 [PZ724]
Beige Cod. 970068 [PZ724]
Natural Cod. 970176 [PZ724]
Marrón Cod. 970069 [PZ724]

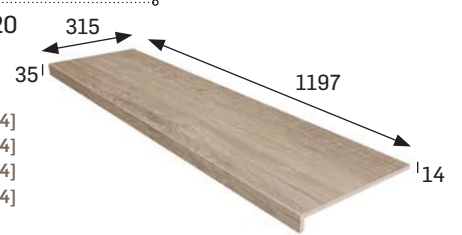

TAPA PELDAÑO REDONDA DCHA

RIGHT ROUNDED STEP COVER

[330x36 mm]

Gris Cod. 905222 [PZ190]
Beige Cod. 905221 [PZ190]
Natural Cod. 905513 [PZ190]
Marrón Cod. 905223 [PZ190]



TAPA PELDAÑO REDONDA IZDA

LEFT ROUNDED STEP COVER

[330x36 mm]

Gris Cod. 905225 [PZ190]
Beige Cod. 905224 [PZ190]
Natural Cod. 905514 [PZ190]
Marrón Cod. 905226 [PZ190]



TAPA PELDAÑO RECTA

STRAIGHT STEP COVER

[315x35 mm]

Gris Cod. 905282 [PZ190]
Beige Cod. 905281 [PZ190]
Natural Cod. 905515 [PZ190]
Marrón Cod. 905283 [PZ190]



ORDESA

PORCELÁNICOS
PORCELAIN TILES



Colores / Colors



Ordesa Gris 15x60

48

PAVIMENTOS FLOOR TILES

	Espe so r (mm) Thick ne s s (mm)	U.M.*	U.M./Caja U.M./Box	U.M./Palet U.M./Pallet	Pzs./U.M. Pcs./U.M.	Pzs./Caja Pcs./Box	Kg./U.M. Kg./U.M.	Kg./Caja Kg./Box	Kg./Palet Kg./Pallet
Tabica 15x120 Riser 15x120	10,4	Pz. Pc.	6	264	1	6	4,24	25,4	1119
Rodapié 30 Skirting board 30	9,5	ml lm	10,21	367,57	3,33	34	1,74	17,6	650
Zanquín redondeado izda. Rounded string left	9,5	Jg. set	5	300	2	10	0,85	4,25	255
Zanquín redondeado dcha. Rounded string right	9,5	Jg. set	5	300	2	10	0,85	4,25	255
Zanquín recto izda. Straight string left	9,5	Jg. set	5	300	2	10	0,85	4,25	255
Zanquín recto dcha. Straight string right	9,5	Jg. set	5	300	2	10	0,85	4,25	255

* Unidad de Medida. Los artículos medidos en m² o ml se sirven contando la junta normal entre piezas.
* Unit of Measure. Items measured in sqm or lm are delivered assuming average joint between pieces.

Anchura recomendada de la junta de colocación: Consultar pág. 15.
Recommended joint width: See pg. 15.

Piezas especiales Special pieces

TABICA 15X120

RISER 15x120

Antideslizante · Anti slip
[147x1197x10,4 mm]

Gris Cod. 904635 [PZ220]
Beige Cod. 904636 [PZ220]
Natural Cod. 905516 [PZ220]
Marrón Cod. 904637 [PZ220]

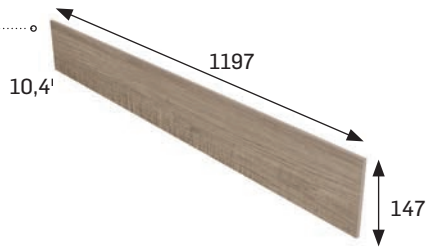

RODAPIÉ 30

SKIRTING BOARD 30

Liso · Smooth
[297x80x9,5 mm]

Gris Cod. 904638 [ML230]
Beige Cod. 904639 [ML230]
Natural Cod. 905517 [ML230]
Marrón Cod. 904640 [ML230]



ZANQUÍN REDONDEADO IZDA.

ROUNDED STRING LEFT SIDE

Liso · Smooth
[293x80/273x9,5 mm]

Gris Cod. 905219 [JG245]
Beige Cod. 905218 [JG245]
Natural Cod. 905521 [JG245]
Marrón Cod. 905220 [JG245]

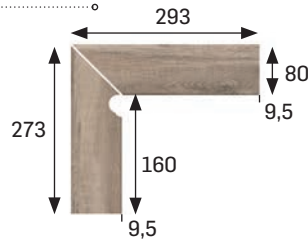

ZANQUÍN REDONDEADO DCHA.

ROUNDED STRING RIGHT SIDE

Liso · Smooth
[293x80/273x9,5 mm]

Gris Cod. 905216 [JG245]
Beige Cod. 905215 [JG245]
Natural Cod. 905522 [JG245]
Marrón Cod. 905217 [JG245]

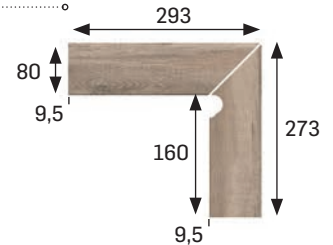

ZANQUÍN RECTO IZDA.

STRAIGHT STRING LEFT SIDE

Antideslizante · Anti slip
[293x80/273x9,5 mm]

Gris Cod. 904644 [JG245]
Beige Cod. 904645 [JG245]
Natural Cod. 905519 [JG245]
Marrón Cod. 904646 [JG245]

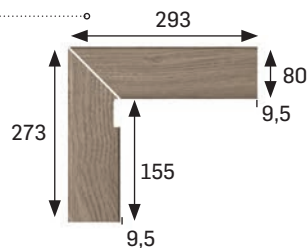

ZANQUÍN RECTO DCHA.

STRAIGHT STRING RIGHT SIDE

Antideslizante · Anti slip
[293x80/273x9,5 mm]

Gris Cod. 904647 [JG245]
Beige Cod. 904648 [JG245]
Natural Cod. 905520 [JG245]
Marrón Cod. 904649 [JG245]

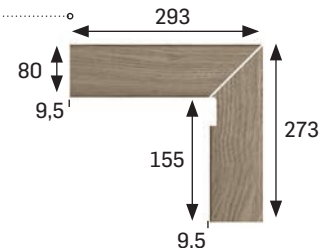

ORDESA

PORCELÁNICOS
PORCELAIN TILES



Colores / Colors



Ordesa Gris 15x60

	Espesor (mm) Thickness (mm)	U.M.*	U.M./Caja U.M./Box	U.M./Palet U.M./Pallet	Pzs./U.M. Pcs./U.M.	Pzs./Caja Pcs./Box	Kg./U.M. Kg./U.M.	Kg./Caja Kg./Box	Kg./Palet Kg./Pallet
Borde desbordante 60 Overflowing edge 60	25	Pz. Pc.	2	60	1	2	9,028	18,056	563
Esq. int. borde desbordante Overflowing internal edge	25	Jg. Set	2	-	2	4	7	14	-
Esq. ext. borde desbordante Overflowing external edge	25	Jg. Set	2	-	2	4	7	14	-
Rejilla monocompact ranurada Monocompact grooved grid	25	Pz. Pc.	5	315	1	5	4,2	20,8	1310
Esquina rejilla Corner grid	25	Set Set	1	-	1	2	7,96	7,96	-
Rejilla flexible ranurada Grooved Flexible grid	25	Pz. Pc.	1	30	1	1	12,7	12,7	381
Canaleta Overflow channel	30	Pz. Pc.	4	288	1	4	2,5	10,2	734
Cantonera External radial tile	-	Pz. Pc.	42	1512	1	42	0,34	14,5	522
Rinconera Internal radial tile	-	Pz. Pc.	35	1260	1	35	0,41	14,2	511
Esq. exterior cantonera External mitre	-	Pz. Pc.	4	-	1	4	0,33	1,3	-
Esq. interior rinconera Internal mitre	-	Pz. Pc.	4	-	1	4	0,33	1,3	-
Escocia cantonera exterior Round external mitre	-	Pz. Pc.	24	-	1	24	0,1	1,9	-
Escocia rinconera interior Round internal mitre	-	Pz. Pc.	24	-	1	24	0,1	1,9	-

* Unidad de Medida. Los artículos medidos en m² o ml se sirven contando la junta normal entre piezas.
* Unit of Measure. Items measured in sqm or lm are delivered assuming average joint between pieces.

Anchura recomendada de la junta de colocación: Consultar pág. 15.
Recommended joint width: See pg. 15.

Piezas especiales Special pieces

BORDE DESBORDANTE 60

OVERFLOWING EDGE 60

Antideslizante · Anti slip
[597x325x25 mm]

Gris	Cod. 904650	[PZ650]
Beige	Cod. 904651	[PZ650]
Natural	Cod. 905523	[PZ650]
Marrón	Cod. 904652	[PZ650]



ESQ. INT. BORDE DESBORDANTE

OVERFLOWING INTERNAL EDGE

Antideslizante · Anti slip
[325x444x119 mm]

Gris	Cod. 904653	[JG762]
Beige	Cod. 904654	[JG762]
Natural	Cod. 905524	[JG762]
Marrón	Cod. 904655	[JG762]

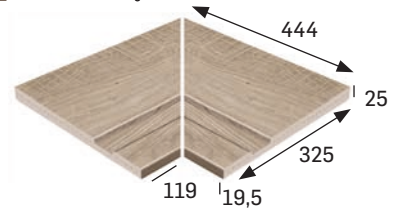

ESQ. EXT. BORDE DESBORDANTE

OVERFLOWING EXTERNAL EDGE

Antideslizante · Anti slip
[325x418x93 mm]

Gris	Cod. 904656	[JG762]
Beige	Cod. 904657	[JG762]
Natural	Cod. 905525	[JG762]
Marrón	Cod. 904658	[JG762]

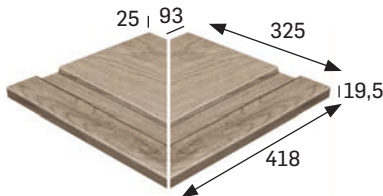

REJILLA MONOCOMPACT RANURADA

MONOCOMPACT GROOVED GRID

Antideslizante / Anti slip **
[291x244x25 mm]

Gris	Cod. 904659	[PZ595]
Beige	Cod. 905038	[PZ595]
Natural	Cod. 905526	[PZ595]
Marrón	Cod. 905037	[PZ595]

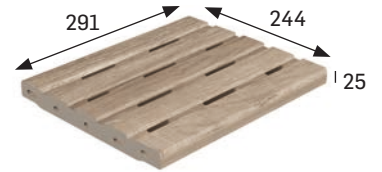

** En rejillas, los agujeros siempre deben ir paralelos al vaso para su mayor resistencia, con canal de 250 mm de ancho.

** Install the grids with the holes always parallel to the pool vessel to get a greater resistance, with a channel 250 mm wide

ESQUINA REJILLA

CORNER GRID

Antideslizante · Anti slip
[388x244x25 x144 mm]

Gris	Cod. 905039	[JG761]
Beige	Cod. 905040	[JG761]
Natural	Cod. 905527	[JG761]
Marrón	Cod. 905041	[JG761]

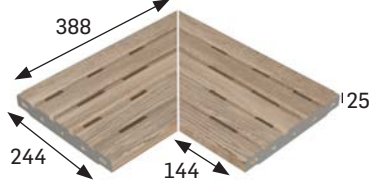

REJILLA FLEXIBLE RANURADA

GROOVED FLEXIBLE GRID *

Antideslizante · Anti slip
[245x25 x52 mm]

Gris	Cod. 904908	[ML780]
Beige	Cod. 905035	[ML780]
Natural	Cod. 905528	[ML780]
Marrón	Cod. 905036	[ML780]



* Disponible bajo pedido. / Available on demand.
Ver/See pg. 14.

CANALETA*

OVERFLOW CHANNEL

Antideslizante · Anti slip
[297x244x30 mm]

Gris	Cod. 904668	[PZ382]
Beige	Cod. 904669	[PZ382]
Natural	Cod. 905529	[PZ382]
Marrón	Cod. 904670	[PZ382]



* Disponible Canaleta con desagüe.
* Overflow channel with drainage available.

CANTONERA

EXTERNAL RADIAL TILE

Antideslizante · Anti slip
[297x42 mm]

Gris	Cod. 904674	[PZ123]
Beige	Cod. 904675	[PZ123]
Natural	Cod. 905531	[PZ123]
Marrón	Cod. 904676	[PZ123]



RINCONERA

INTERNAL RADIAL TILE

Antideslizante · Anti slip
[297x42 mm]

Gris	Cod. 904677	[PZ123]
Beige	Cod. 904678	[PZ123]
Natural	Cod. 905532	[PZ123]
Marrón	Cod. 904679	[PZ123]



ESQ. EXT. CANTONERA

EXTERNAL MITRE

Antideslizante · Anti slip
[75x75 mm]

Gris	Cod. 904686	[PZ355]
Beige	Cod. 904687	[PZ355]
Natural	Cod. 905533	[PZ355]
Marrón	Cod. 904688	[PZ355]

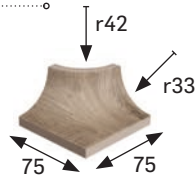

ESQ. INT. RINCONERA

INTERNAL MITRE

Antideslizante · Anti slip
[75x75 mm]

Gris	Cod. 904689	[PZ355]
Beige	Cod. 904690	[PZ355]
Natural	Cod. 905534	[PZ355]
Marrón	Cod. 904691	[PZ355]



ESCOCIA CANTONERA EXTERIOR

ROUND EXTERNAL MITRE

Antideslizante · Anti slip

Gris	Cod. 904680	[PZ280]
Beige	Cod. 904681	[PZ280]
Natural	Cod. 905535	[PZ280]
Marrón	Cod. 904682	[PZ280]



ESCOCIA RINCONERA INTERIOR

ROUND INTERNAL MITRE

Antideslizante · Anti slip

Gris	Cod. 904683	[PZ280]
Beige	Cod. 904684	[PZ280]
Natural	Cod. 905536	[PZ280]
Marrón	Cod. 904685	[PZ280]

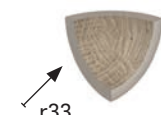

OCEAN

PORCELÁNICOS PORCELAIN TILES

Colores / Colors

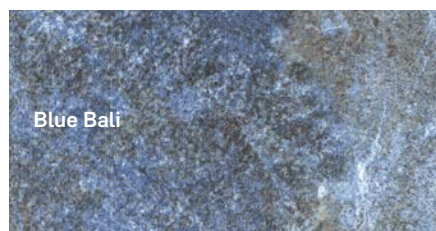

Blue Bali

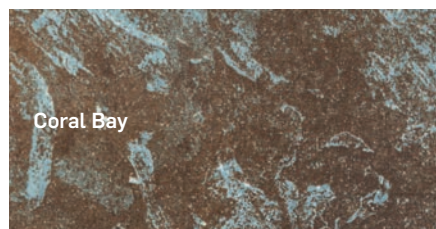

Coral Bay

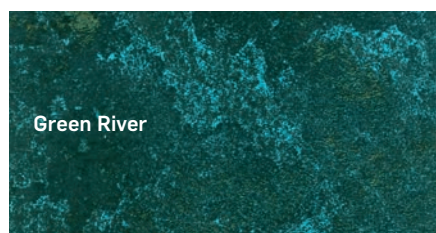

Green River



Pearl





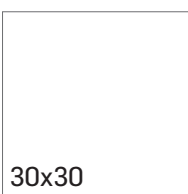











Los colores son indicativos.
Colors are just indicative.

(cm) Formatos / Sizes



52

PAVIMENTOS FLOOR TILES

	PORCELÁNICO PORCELAIN	
	ESMALTADO GLAZED	
	Características dimensionales Dimension tolerance	<1% / <0,6% máx 2 mm.
	Absorción de agua Water absorption	E≤0,5%
	Coef. Dilatación térmica lineal Linear thermal expansion coefficient	5,8x10 ⁻⁶ xC ⁻¹
	Resistencia a la flexión Breaking strength	>40N/mm ²
	Resistencia a la abrasión superficial Resistance to surface abrasion	Coral Bay/Pearl/ Blue Bali PEI 4 Green River PEI 3
	Resistencia a las manchas Resistance to stains	class 5 class 5
	Péndulo (CTE) Not required out of Spain	Ocean brillo class 0 Ocean glossy class 0 Ocean mate class 3 Ocean matt class 3
	A pie descalzo Barefoot slip resistance	Ocean brillo A Ocean glossy A Ocean mate C Ocean matt C
	A pie calzado Slip resistance with footwear	Ocean brillo <R9 Ocean glossy <R9 Ocean mate R11 Ocean matt R11
	Coeficiente fricción dinámico (DCOF) Dynamic coefficient of friction	Mate antideslizante Matt Antislip 0,70
	Resistencia al cuarteo Crazing resistance	sí/yes
	Resistencia a la helada Frost resistance	✓
	Resistencia al choque térmico Resistance to thermal shock	✓
	Resistencia química Chemical resistance	✓
	Destonificado Shade variation	V3 moderado mild



Ocean Coral Bay 15x15

OCEAN

PORCELÁNICOS
PORCELAIN TILES



Solo Mate/ Matt only

Colores / Colors

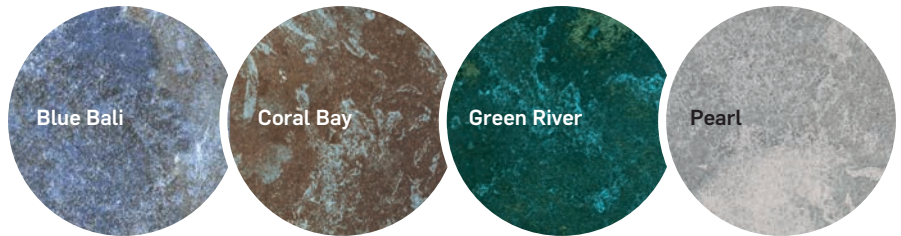

BASE 15x15 TILE 15x15

[147x147x8,5 mm]

Blue Bali Brillo/Glossy	Cod. 905573	[MC583]
Coral Bay Brillo/Glossy	Cod. 905498	[MC583]
Green River Brillo/Glossy	Cod. 905499	[MC583]
Pearl Brillo/Glossy	Cod. 905501	[MC583]
Blue Bali Mate/Matt	Cod. 905574	[MC583]
Coral Bay Mate/Matt	Cod. 905502	[MC583]
Green River Mate/Matt	Cod. 905503	[MC583]
Pearl Mate/Matt	Cod. 905505	[MC583]

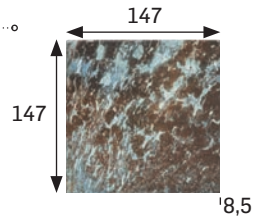

BASE 30x30 TILE 30x30

[297x297x8,5 mm]

Blue Bali Mate/Matt	Cod. 905565	[MC479]
Coral Bay Mate/Matt	Cod. 904803	[MC479]
Green River Mate/Matt	Cod. 904802	[MC479]
Pearl Mate/Matt	Cod. 905273	[MC479]

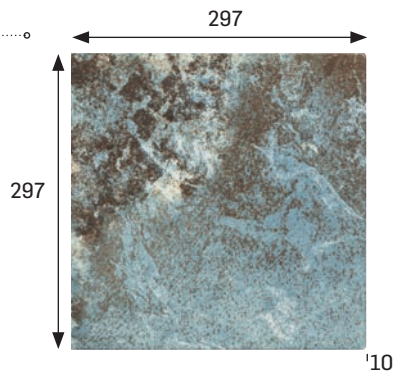

Variaciones tonalidad **

Color scheme

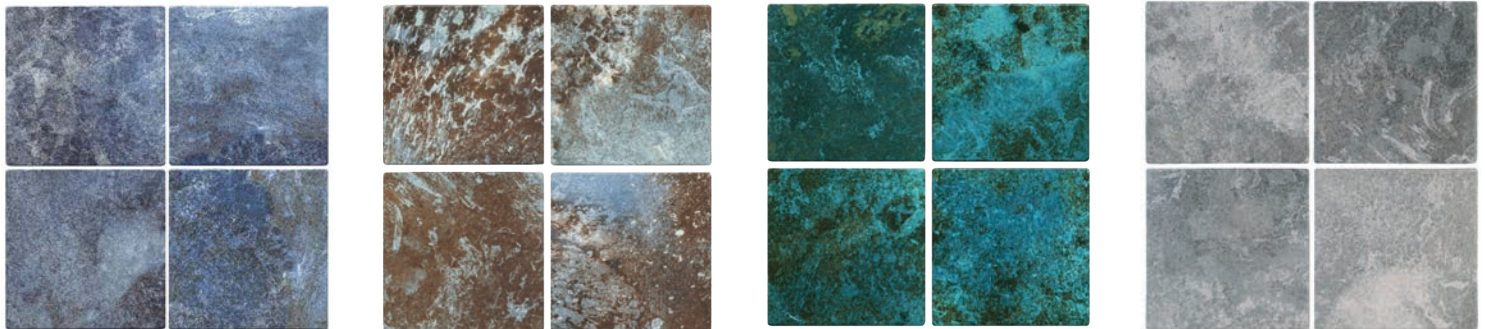

Blue Bali

Coral Bay

Green River

Pearl

** Combinación de 4 piezas para mostrar la destonificación. **
4 pieces combination to show shade variations.

	Espeor (mm) Thickness (mm)	U.M.*	U.M./Caja U.M./Box	U.M./Palet U.M./Pallet	Pzs./U.M. Pcs./U.M.	Pzs./Caja Pcs./Box	Kg./U.M. Kg./U.M.	Kg./Caja Kg./Box	Kg./Palet Kg./Pallet
Base 15x15 Tile 15x15	8,5	m ² sqm	0,72	60,48	44,44	32	18,49	13,32	1118,6
Base 30x30 Tile 30x30	10	m ² sqm	0,99	71,29	11,11	11	21,54	21,33	1536

* Unidad de Medida. Los artículos medidos en m² o ml se sirven contando la junta normal entre piezas.
* Unit of Measure. Items measured in sqm or lm are delivered assuming average joint between pieces.

Anchura recomendada de la junta de colocación: Consultar pág. 15.
Recommended joint width: See pg. 15.



Ocean Blue Bali 15x15

OCEAN

PORCELÁNICOS
PORCELAIN TILES



Solo Mate/ Matt only

Colores / Colors

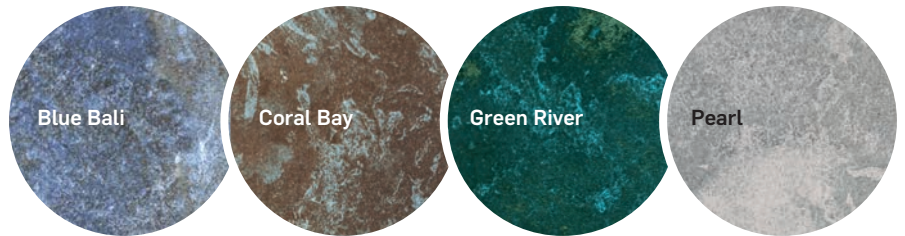

Ocean Green River 15x15

	Espesor (mm) Thickness (mm)	U.M.*	U.M./Caja U.M./Box	U.M./Palet U.M./Pallet	Pzs./U.M. Pcs./U.M.	Pzs./Caja Pcs./Box	Kg./U.M. Kg./U.M.	Kg./Caja Kg./Box	Kg./Palet Kg./Pallet
Canto romo Bull nose	8,5	m ² sqm	0,71	59,72	42,19	30	19,79	14,07	1182
Cantonera External radial tile	-	Pz. Pc.	42	1512	1	42	0,34	14,5	522
Rinconera Internal radial tile	-	Pz. Pc.	35	1260	1	35	0,41	14,2	511
Esq. exterior cantonera External mitre	-	Pz. Pc.	4	-	1	4	0,33	1,3	-
Esq. interior rinconera Internal mitre	-	Pz. Pc.	4	-	1	4	0,33	1,3	-
Escocia rinconera interior Round internal mitre	-	Pz. Pc.	24	-	1	24	0,1	1,9	-
Escocia cantonera exterior Round external mitre	-	Pz. Pc.	24	-	1	24	0,1	1,9	-

* Unidad de Medida. Los artículos medidos en m² o ml se sirven contando la junta normal entre piezas.
* Unit of Measure. Items measured in sqm or lm are delivered assuming average joint between pieces.

Anchura recomendada de la junta de colocación: Consultar pág. 15.
Recommended joint width: See pg. 15.

Piezas especiales Special pieces

CANTO ROMO

BULLNOSE

[147x148x8 mm]

Brillo/Glossy

Blue Bali	Cod. 905778	[PZ085]
Coral Bay	Cod. 905188	[PZ085]
Green River	Cod. 905186	[PZ085]
Pearl	Cod. 905272	[PZ085]

Mate/Matt

Blue Bali	Cod. 905566	[PZ085]
Coral Bay	Cod. 905185	[PZ085]
Green River	Cod. 905183	[PZ085]
Pearl	Cod. 905271	[PZ085]

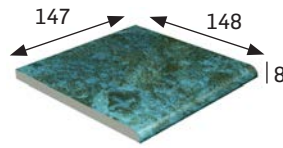

CANTONERA

EXTERNAL RADIAL TILE

Mate/Matt

[297x42 mm]

Blue Bali	Cod. 905567	[PZ123]
Coral Bay	Cod. 905170	[PZ123]
Green River	Cod. 905168	[PZ123]
Pearl	Cod. 905266	[PZ123]

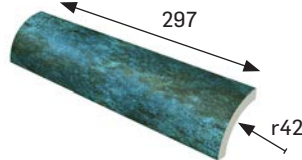

RINCONERA

INTERNAL RADIAL TILE

Mate/Matt

[297x42 mm]

Blue Bali	Cod. 905568	[PZ123]
Coral Bay	Cod. 905167	[PZ123]
Green River	Cod. 905165	[PZ123]
Pearl	Cod. 905265	[PZ123]

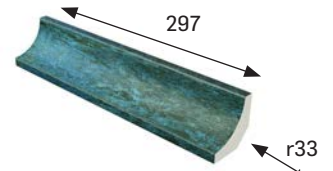

ESQ. EXT. CANTONERA

EXTERNAL MITRE

Mate/Matt

[75x75 mm]

Blue Bali	Cod. 905569	[PZ355]
Coral Bay	Cod. 905182	[PZ355]
Green River	Cod. 905180	[PZ355]
Pearl	Cod. 905270	[PZ355]

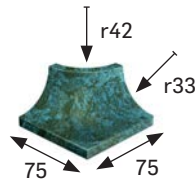

ESQ. INT. RINCONERA

INTERNAL MITRE

Mate/Matt

[75x75 mm]

Blue Bali	Cod. 905570	[PZ355]
Coral Bay	Cod. 905179	[PZ355]
Green River	Cod. 905177	[PZ355]
Pearl	Cod. 905269	[PZ355]

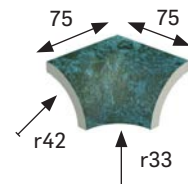

ESCOCIA CANTONERA EXTERIOR

ROUND EXTERNAL MITRE

Mate/Matt

Blue Bali	Cod. 905571	[PZ280]
Coral Bay	Cod. 905176	[PZ280]
Green River	Cod. 905174	[PZ280]
Pearl	Cod. 905268	[PZ280]

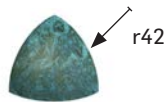

ESCOCIA RINCONERA INTERIOR

ROUND INTERNAL MITRE

Mate/Matt

Blue Bali	Cod. 905572	[PZ280]
Coral Bay	Cod. 905173	[PZ280]
Green River	Cod. 905171	[PZ280]
Pearl	Cod. 905267	[PZ280]



OCEAN

PORCELÁNICOS
PORCELAIN TILES

Colores / Colors



Blue Bali

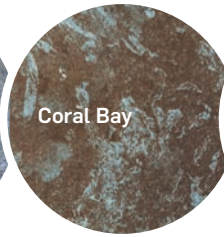

Coral Bay

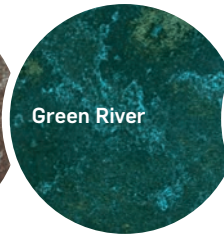

Green River

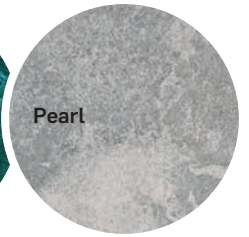

Pearl



Ocean Coral Bay 15x15



Ocean Pearl 15x15

ITACA

PORCELÁNICOS PORCELAIN TILES

Colores / Colors

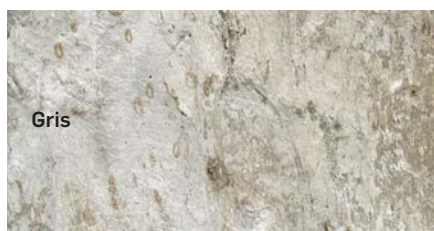





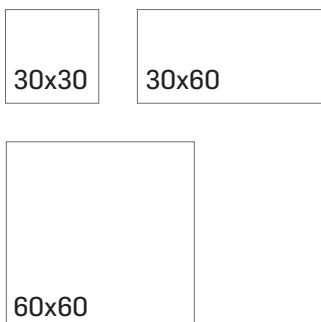









Los colores son indicativos.
Colors are just indicative.

(cm) Formatos / Sizes



60 PAVIMENTOS FLOOR TILES

	PORCELÁNICO PORCELAIN	
	ESMALTADO GLAZED	
	Características dimensionales Dimension tolerance	<1% / <0,6% máx 2 mm.
	Absorción de agua Water absorption	E≤0,5%
	Coef. Dilatación térmica lineal Linear thermal expansion coefficient	5,8x10 ⁻⁶ xC ⁻¹
	Resistencia a la flexión Breaking strength	>40N/mm ²
	Resistencia a la abrasión superficial Resistance to surface abrasion	PEI 4
	Resistencia a las manchas Resistance to stains	clase 5 class 5
	Péndulo (CTE) Not required out of Spain	Antideslizante clase 3 Anti slip class 3
	A pie descalzo Barefoot slip resistance	Antideslizante / Anti slip C
	A pie calzado Slip resistance with footwear	Antideslizante / Anti slip R11
	Resistencia al cuarteo Crazing resistance	sí/yes
	Resistencia a la helada Frost resistance	✓
	Resistencia al choque térmico Resistance to thermal shock	✓
	Resistencia química Chemical resistance	✓
	Destonificado Shade variation	V4 considerable substantial
	Antibacteriano Antibacterian	R>2 Reducción antibacteriana >99 %



Itaca Mix 30x30

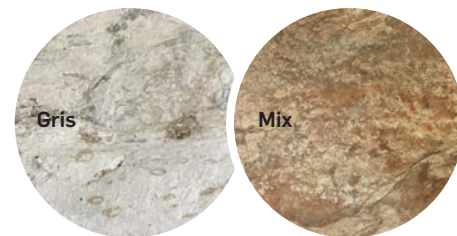

BASE 30x30 TILE 30x30

[297x297x10 mm]

Gris Antideslizante / Anti slip

Cod. 904075 [MC479]

Mix Antideslizante / Anti slip

Cod. 904079 [MC479]

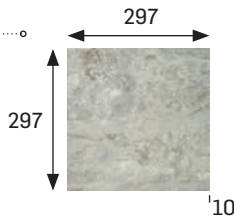

BASE 30x60 TILE 30x60

[297x597x10 mm]

Gris Antideslizante / Anti slip

Cod. 904089 [MC479]

Mix Antideslizante / Anti slip

Cod. 904093 [MC479]



BASE 60x60 TILE 60x60

[597x597x10 mm]

Gris Antideslizante / Anti slip

Cod. 904129 [MC479]

Mix Antideslizante / Anti slip

Cod. 904133 [MC479]

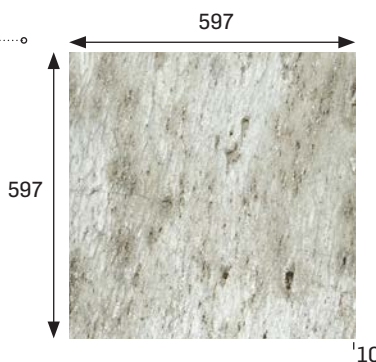

Variaciones tonalidad

Color scheme



Gris

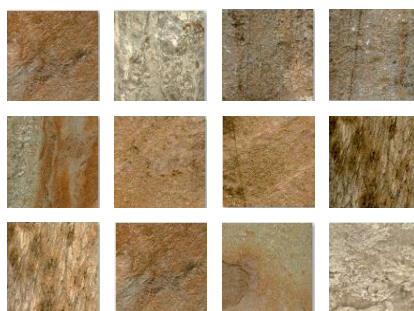

Mix

	Espesor (mm) Thickness (mm)	U.M.*	U.M./Caja U.M./Box	U.M./Palet U.M./Pallet	Pzs./U.M. Pcs./U.M.	Pzs./Caja Pcs./Box	Kg./U.M. Kg./U.M.	Kg./Caja Kg./Box	Kg./Palet Kg./Pallet
Base 30x30 Tile 30x30	10	m ² sqm	0,99	71,29	11,11	11	21,54	21,33	1536
Base 30x60 Tile 30x60	10	m ² sqm	1,08	64,86	5,55	6	21,65	23,38	1403
Base 60x60 Tile 60x60	10	m ² sqm	1,44	60,48	2,78	4	22,53	32,44	1362,5

* Unidad de Medida. Los artículos medidos en m² o ml se sirven contando la junta normal entre piezas.
* Unit of Measure. Items measured in sqm or lm are delivered assuming average joint between pieces.

Anchura recomendada de la junta de colocación: Consultar pág. 15.
Recommended joint width: See pg. 15.



Itaca Mix 30x30

ITACA

PORCELÁNICOS
PORCELAIN TILES



Colores / Colors

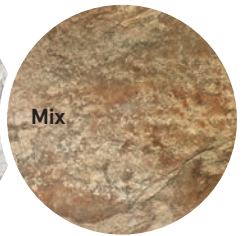

Itaca Mix 30x30

64

PAVIMENTOS FLOOR TILES

	Espesor (mm) Thickness (mm)	U.M.*	U.M./Caja U.M./Box	U.M./Palet U.M./Pallet	Pzs./U.M. Pcs./U.M.	Pzs./Caja Pcs./Box	Kg./U.M. Kg./U.M.	Kg./Caja Kg./Box	Kg./Palet Kg./Pallet
Peldaño redondeado 30 Rounded stair-tread 30	14	Pz. Pc.	4	256	1	4	3,1	12,6	806
Peldaño redondeado 120 Rounded stair-tread 120	14	Pz. Pc.	2	32	1	2	12,1	24,2	387,2
Peldaño recto 120 Straight stair-tread 120	14	Pz. Pc.	2	32	1	2	11,32	22,6	362,2
Tapa peldaño redonda dcha. Right rounded step cover	-	Pz. Pc.	10	**	1	10	0,17	1,7	**
Tapa peldaño redonda izda. Left rounded step cover	-	Pz. Pc.	10	**	1	10	0,17	1,7	**
Tapa peldaño recta Straight step cover	-	Pz. Pc.	10	**	1	10	0,17	1,7	**

* Unidad de Medida. Los artículos medidos en m² o ml se sirven contando la junta normal entre piezas.
* Unit of Measure. Items measured in sqm or lm are delivered assuming average joint between pieces.

Anchura recomendada de la junta de colocación: Consultar pág. 15.
Recommended joint width: See pg. 15.

** Consultar datos de embalaje con fábrica / ** Ask for packing information to the factory

Piezas especiales Special pieces

PELDAÑO REDONDEADO 30 ROUNDED STAIR-TREAD 30

Antideslizante · Anti slip
[297x330x14 mm]

Gris Cod. 970011 [PZ287]
Mix Cod. 970012 [PZ287]

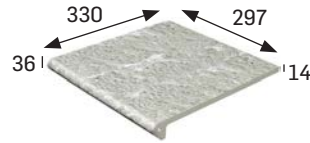

PELDAÑO REDONDEADO 120 ROUNDED STAIR-TREAD 120

Antideslizante · Anti slip
[1197x330x14 mm]

Gris Cod. 970167 [PZ724]
Mix Cod. 970168 [PZ724]



PELDAÑO RECTO 120 STRAIGHT STAIR-TREAD 120

Antideslizante · Anti slip
[1197x315x14 mm]

Gris Cod. 970099 [PZ724]
Mix Cod. 970098 [PZ724]

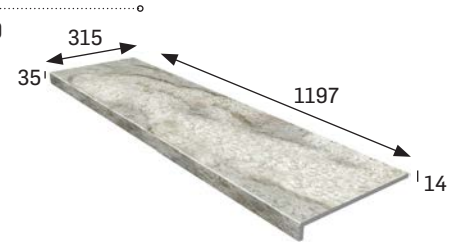

TAPA PELDAÑO REDONDA DCHA RIGHT ROUNDED STEP COVER

[330x36 mm]

Gris Cod. 905230 [PZ190]
Mix Cod. 905229 [PZ190]



TAPA PELDAÑO REDONDA IZDA LEFT ROUNDED STEP COVER

[330x36 mm]

Gris Cod. 905232 [PZ190]
Mix Cod. 905231 [PZ190]



TAPA PELDAÑO RECTA STRAIGHT STEP COVER

[315x35 mm]

Gris Cod. 905288 [PZ190]
Mix Cod. 905287 [PZ190]



ITACA

PORCELÁNICOS
PORCELAIN TILES



Colores / Colors

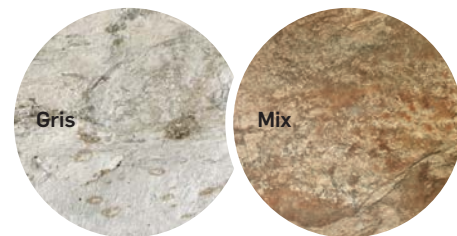

Itaca Gris 30x30

66

PAVIMENTOS FLOOR TILES

	Espe ^s or (mm) Thick ⁿ ess (mm)	U.M.*	U.M./Caja U.M./Box	U.M./Palet U.M./Pallet	Pzs./U.M. Pcs./U.M.	Pzs./Caja Pcs./Box	Kg./U.M. Kg./U.M.	Kg./Caja Kg./Box	Kg./Palet Kg./Pallet
Tabica 15x120 Riser 15x120	10,4	Pz. Pc.	6	264	1	6	4,24	25,4	1119
Rodapié 30 Skirting board 30	9,5	ml lm	10,21	367,57	3,33	34	1,74	17,6	650
Esquina redondeada Rounded stair-tread corner	14	Pz. Pc.	2	60	1	2	4,25	8,5	255
Zanquín redondeado izda. Rounded string left	9,5	Jg. set	5	300	2	10	0,85	4,25	255
Zanquín redondeado dcha. Rounded string right	9,5	Jg. set	5	300	2	10	0,85	4,25	255
Zanquín recto izda. Straight string left	9,5	Jg. set	5	300	2	10	0,85	4,25	255
Zanquín recto dcha. Straight string right	9,5	Jg. set	5	300	2	10	0,85	4,25	255

* Unidad de Medida. Los artículos medidos en m² o ml se sirven contando la junta normal entre piezas.
* Unit of Measure. Items measured in sqm or lm are delivered assuming average joint between pieces.

Anchura recomendada de la junta de colocación: Consultar pág. 15.
Recommended joint width: See pag. 15.

Piezas especiales Special pieces

TABICA 15x120

RISER 15x120

Antideslizante · Anti slip
[147x1197x10,4 mm]

Gris Cod. 904821 [PZ220]
Mix Cod. 904822 [PZ220]



RODAPIÉ 30

SKIRTING BOARD 30

Antideslizante · Anti slip
[297x80x9,5 mm]

Gris Cod. 903874 [ML230]
Mix Cod. 903894 [ML230]



ESQUINA REDONDEADA

ROUNDED STAIR-TREAD CORNER

Antideslizante · Anti slip
[330x330x14 mm]

Gris Cod. 903873 [PZ715]
Mix Cod. 903893 [PZ715]



ZANQUÍN REDONDEADO IZDA.

ROUNDED STRING LEFT SIDE

Antideslizante · Anti slip
[293x80/273x9,5 mm]

Gris Cod. 904527 [JG245]
Mix Cod. 904526 [JG245]

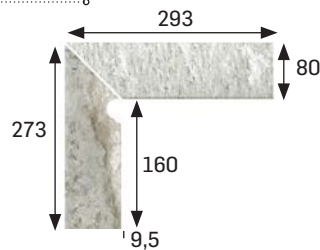

ZANQUÍN REDONDEADO DCHA.

ROUNDED STRING RIGHT SIDE

Antideslizante · Anti slip
[293x80/273x9,5 mm]

Gris Cod. 904529 [JG245]
Mix Cod. 904528 [JG245]

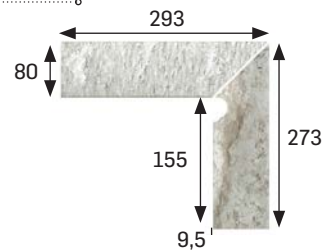

ZANQUÍN RECTO IZDA.

STRAIGHT STRING LEFT SIDE

Antideslizante · Anti slip
[293x80/273x9,5 mm]

Gris Cod. 904378 [JG245]
Mix Cod. 904377 [JG245]

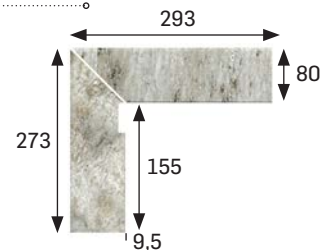

ZANQUÍN RECTO DCHA.

STRAIGHT STRING RIGHT SIDE

Antideslizante · Anti slip
[293x80/273x9,5 mm]

Gris Cod. 904380 [JG245]
Mix Cod. 904379 [JG245]

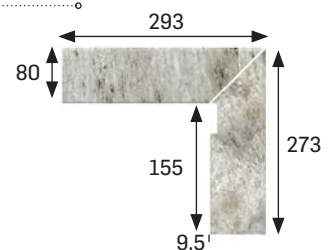

ITACA

PORCELÁNICOS
PORCELAIN TILES



Colores / Colors

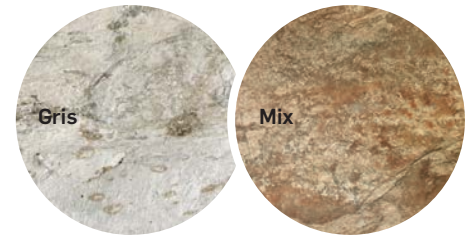

Itaca Gris 30x60

	Espesor (mm) Thickness (mm)	U.M.*	U.M./Caja U.M./Box	U.M./Palet U.M./Pallet	Pzs./U.M. Pcs./U.M.	Pzs./Caja Pcs./Box	Kg./U.M. Kg./U.M.	Kg./Caja Kg./Box	Kg./Palet Kg./Pallet
Borde desbordante 60 Overflowing edge 60	25	Pz. Pc.	2	60	1	2	9,028	18,056	563
Esq. int. borde desbordante Overflowing internal edge	25	Jg. Set	2	-	2	4	7	14	-
Esq. ext. borde desbordante Overflowing external edge	25	Jg. Set	2	-	2	4	7	14	-
Rejilla monocompact ranurada Monocompact grooved grid	25	Pz. Pc.	5	315	1	5	4,2	20,8	1310
Esquina rejilla Corner grid	25	Set Set	1	-	1	2	7,96	7,96	-
Rejilla flexible ranurada Grooved Flexible grid	25	Pz. Pc.	1	30	1	1	12,7	12,7	381
Canaleta Overflow channel	30	Pz. Pc.	4	288	1	4	2,5	10,2	734
Cantonera External radial tile	-	Pz. Pc.	42	1512	1	42	0,34	14,5	522
Rinconera Internal radial tile	-	Pz. Pc.	35	1260	1	35	0,41	14,2	511
Esq. exterior cantonera External mitre	-	Pz. Pc.	4	-	1	4	0,33	1,3	-
Esq. interior rinconera Internal mitre	-	Pz. Pc.	4	-	1	4	0,33	1,3	-
Escocia cantonera exterior Round external mitre	-	Pz. Pc.	24	-	1	24	0,1	1,9	-
Escocia rinconera interior Round internal mitre	-	Pz. Pc.	24	-	1	24	0,1	1,9	-

* Unidad de Medida. Los artículos medidos en m² o ml se sirven contando la junta normal entre piezas.
* Unit of Measure. Items measured in sqm or lm are delivered assuming average joint between pieces.

Anchura recomendada de la junta de colocación: Consultar pág. 15.
Recommended joint width: See pg. 15.

Piezas especiales Special pieces

BORDE DESBORDANTE 60

OVERFLOWING EDGE 60

Antideslizante · Anti slip
[597x325x25 mm]

Gris Cod. 904382 [PZ650]
Mix Cod. 904381 [PZ650]

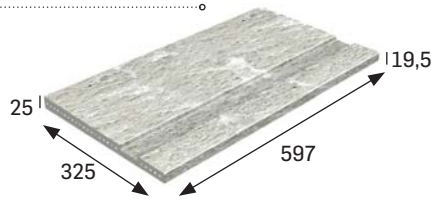

ESQ. INT. BORDE DESBORDANTE

OVERFLOWING INTERNAL EDGE

Antideslizante · Anti slip
[325x444x119 mm]

Gris Cod. 903879 [JG762]
Mix Cod. 903899 [JG762]

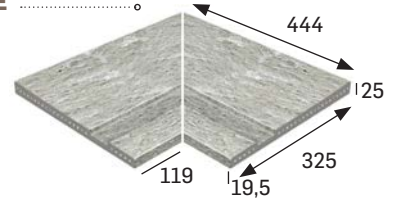

ESQ. EXT. BORDE DESBORDANTE

OVERFLOWING EXTERNAL EDGE

Antideslizante · Anti slip
[325x418x93 mm]

Gris Cod. 903878 [JG762]
Mix Cod. 903898 [JG762]

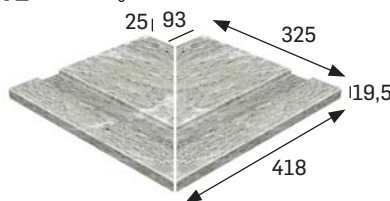

REJILLA MONOCOMPACT RANURADA

MONOCOMPACT GROOVED GRID

Antideslizante / Anti slip **
[291x244x25 mm]

Gris Cod. 905044 [PZ595]
Mix Cod. 905045 [PZ595]

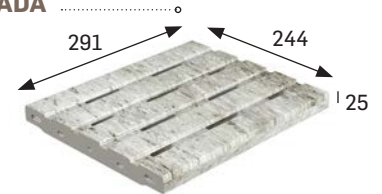

** En rejillas, los agujeros siempre deben ir paralelos al vaso para su mayor resistencia, con canal de 250 mm de ancho.

** Install the grids with the holes always parallel to the pool vessel to get a greater resistance, with a channel 250 mm wide

ESQUINA REJILLA

CORNER GRID

Antideslizante · Anti slip
[388x244x25 x144 mm]

Gris Cod. 905046 [JG761]
Mix Cod. 905047 [JG761]

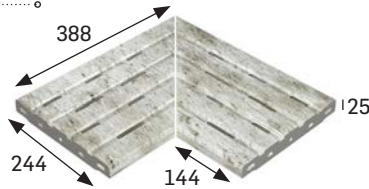

REJILLA FLEXIBLE RANURADA

GROOVED FLEXIBLE GRID *

Antideslizante · Anti slip
[245x25 x52 mm]

Gris Cod. 905042 [ML780]
Mix Cod. 905043 [ML780]

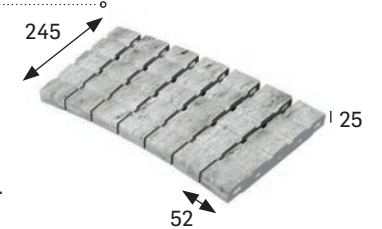

* Disponible bajo pedido. / Available on demand.
Ver/See pg. 14.

CANALETA*

OVERFLOW CHANNEL

Antideslizante · Anti slip
[297x244x30 mm]

Gris Cod. 903019 [PZ382]
Mix Cod. 903017 [PZ382]

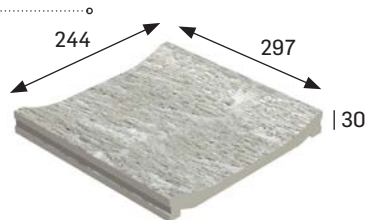

* Disponible Canaleta con desagüe.
* Overflow channel with drainage available.

CANTONERA

EXTERNAL RADIAL TILE

Antideslizante · Anti slip
[297x42 mm]

Gris Cod. 904388 [PZ123]
Mix Cod. 904387 [PZ123]



RINCONERA

INTERNAL RADIAL TILE

Antideslizante · Anti slip
[297x42 mm]

Gris Cod. 904386 [PZ123]
Mix Cod. 903919 [PZ123]



ESQ. EXT. CANTONERA

EXTERNAL MITRE

Antideslizante · Anti slip
[75x75 mm]

Gris Cod. 904394 [PZ355]
Mix Cod. 904393 [PZ355]



ESQ. INT. RINCONERA

INTERNAL MITRE

Antideslizante · Anti slip
[75x75 mm]

Gris Cod. 904396 [PZ355]
Mix Cod. 904395 [PZ355]



ESCOCIA CANTONERA EXTERIOR

ROUND EXTERNAL MITRE

Antideslizante · Anti slip

Gris Cod. 904392 [PZ280]
Mix Cod. 904391 [PZ280]



ESCOCIA RINCONERA INTERIOR

ROUND INTERNAL MITRE

Antideslizante · Anti slip

Gris Cod. 904390 [PZ280]
Mix Cod. 904389 [PZ280]

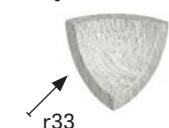



Esmaltados / Natural Glazed Tiles / Natural



EXTRUSIÓN VERTICAL

Nuestra gama de productos klinker se fabrica mediante la forma de extrusión más tradicional. Los formatos que se obtienen van desde 15x15 cm hasta 33x50 cm, con espesores de entre 10 y 20 mm.

Todas las piezas destacan por sus excelentes prestaciones de antideslizamiento y antihelada, además de otras muchas ventajas en cuanto a dureza, resistencia y durabilidad. Son productos diseñados especialmente para áreas de exterior y en cada colección se fabrican kits completos en los que se facilitan las baldosas acompañadas de peldaños, esquinas, rodapiés, zanquines, vierteaguas y pasamanos. En muchas de estas colecciones ofrecemos también remates de piscina, rejillas cerámicas y todo tipo de piezas especiales para este tipo de construcciones.

El klinker tradicional puede presentarse en acabado natural o esmaltado. Disponemos de diferentes colecciones para ambos casos, que consiguen distintas estéticas, pero con las mismas prestaciones.

VERTICAL EXTRUSION

Our klinker product range is manufactured using the most traditional extrusion methods. Formats range from 15x15 cm up to 33x50 cm, with thicknesses between 10 and 20 mm.

All styles stand out for their excellent anti-slip and anti-freeze performance, and many other advantages in terms of hardness, strength and durability. Products are specially designed for outdoor areas, and each collection features complete kits including tiles, steps, corners, skirtings, strings and handrails. In many of these collections we also offer pool edges, ceramic grids and all kind of special parts for this type of construction.

Traditional klinker comes in natural or glazed finish. We have different collections for both versions which offer different aesthetics but with the same features.

CARACTERÍSTICAS

- El proceso de extrusión dota a las piezas de una microestructura interna laminar, homogénea, estable y resistente ante esfuerzos mecánicos. Además, se propicia un buen intercambio aire/agua, haciendo que las piezas sean impermeables y, a su vez, sean capaces de liberar humedades residuales del soporte hacia los costados y puedan ser evacuadas a través de las juntas.
- La resistencia mecánica que aporta la estructura, en combinación con su transpirabilidad, otorgan al material (siguiendo una correcta colocación) una extremada resistencia a la helada y al choque térmico.
- Las composición de las arcillas y esmaltes utilizados, unidos al exigente proceso de fabricación y a las altas temperaturas de cocción dan como resultado productos altamente resistentes tanto a la abrasión profunda (para productos no esmaltados) como a la superficial (para productos esmaltados).
- Posibilita la obtención de geometrías con espesor variable para diferentes aristas de una misma pieza.
- La tecnología y proceso de extrusión nos permiten además obtener las citadas complicadas geometrías sin perder resistencia ni tener merma en sus características técnicas.

CHARACTERISTICS

- The extrusion process leads to tiles with a stable uniform lamellar internal structure and subsequent higher resistance to mechanical forces. It also ensures a good exchange of air and water, resulting in waterproof tiles, able to divert and release residual moisture from the substrate through the joints between the tiles.
- Because the tiles transpire and also boast a high mechanical resistance due to their structure, when laid correctly, they are extremely resistant to frost and ice and thermal shocks.
- In addition to the composition of the clays and glazes used to make them, the high-quality manufacturing process and high firing temperatures lead to products with a high resistance to deep abrasion (in the case of unglazed tiles) and high resistance to surface abrasion (in the case of glazed tiles).
- It allows the obtaining of geometries with variable thickness for different edges of the same piece.
- The extrusion process and technology that are used also allow for the creation of complex shapes without any reduction in the tiles' resistance or technical properties.

El proceso de extrusión consta de tres fases principales: el conformado, el secado y la cocción. En ellas intervienen 4 elementos básicos, tierra, agua, aire y fuego:

The **extrusion process** entails three main stages: shaping, drying and firing. Four basic elements are involved in them: clay, water, air and fire:



Proceso y estructura materiales extrudidos Gres Aragón.
Process and structure of Gres Aragón extruded materials.

Proceso de extrusión

Extrusion process

GRES ARAGÓN

I+D+I en procesos cerámicos

Gres Aragón continúa invirtiendo en I+D+I con el objetivo de desarrollar e implantar nuevos procesos productivos que permitan tomar las ventajas de cada uno de ellos y minimizar los inconvenientes, creando así un tipo de proceso mucho más versátil. El objetivo principal es fabricar las diferentes piezas por medio del proceso que mejores prestaciones técnicas les confieran según el uso al que vayan destinadas.

Un ejemplo de nuestra filosofía productiva es el proceso de extrusión, con unas singularidades que lo hacen único dentro del sector cerámico.

R+ D + I in ceramic processes

Gres Aragón continues to invest in R+D+I with the aim of developing and implementing new production processes that allow to take advantages of each one of them and to minimize the drawbacks, thus creating a much more versatile type of process. The main objective is to manufacture the different parts by means of the process that confers them the best technical benefits according to the use to which they are destined.

An example of our productive philosophy is the extrusion process, with singularities that make it unique in the ceramic sector.

1

En el conformado se unen tierra y agua para crear una masa plástica, que bajo presión de vacío, es amasada y empujada a través de una boquilla que nos permite obtener piezas con el espesor variable. De gran aplicación para obtener piezas especiales como peldaños o bordes de piscinas.

During the shaping stage, clay and water are combined, using vacuum pressure, to create a plastic mix and then pushed through a nozzle to make tiles of variable thicknesses. This process is widely used to make special tile pieces, like step tiles or swimming pool border tiles.

2

Una vez moldeadas las piezas, son sometidas a la acción del aire caliente para eliminar su contenido de humedad.

Once the tiles have been shaped, hot air is used to remove the moisture content.

3

Posteriormente son cocidas a 1.300 °C, obteniendo una perfecta vitrificación de las mismas.

They are then fired at 1,300°C to ensure perfect vitrification.

Este proceso se caracteriza por obtener materiales que pueden ser reciclados en su totalidad, y admite hasta un 40% de materiales reciclados en su proceso estándar.

With the extrusion method, fully recyclable tiles can be made, composed up to 40% recycled material in standard processes.

MYTHO

ESMALTADOS GLAZED TILES

Colores / Colors

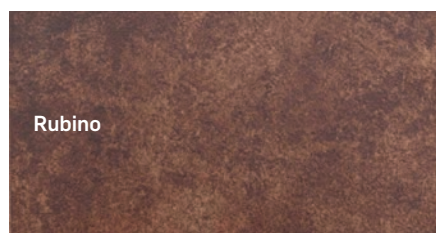
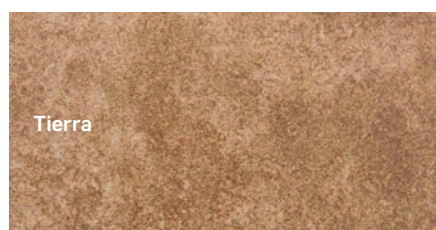
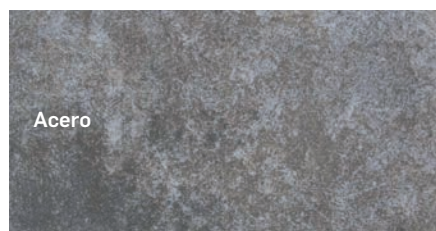

Los colores son indicativos.
Colors are just indicative.

(cm) Formatos / Sizes

6x33

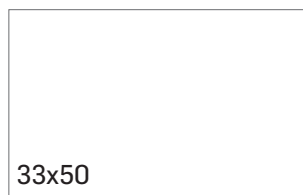

	ESMALTADO GLAZED	
	Características dimensionales Dimension tolerance	<1,25% máx 2 mm
	Absorción de agua Water absorption	3<E≤6%
	Coef. Dilatación térmica lineal Linear thermal expansion coefficient	3,8x10 ⁻⁶ xC ⁻¹
	Resistencia a la flexión Breaking Strength	20N/mm ²
	Resistencia a la abrasión superficial Resistance to surface abrasion	Acero PEI 4 Rubino/Tierra PEI 3
	Desgaste tránsito peatonal Erosion to pedestrian transit	H6
	Resistencia al rayado (Método Mohs) Scratch hardness of surface (Mohs Method)	6 - 9
	Resistencia a las manchas Resistance to stains	class 5 class 5
	Péndulo (CTE) Not required out of Spain	class 1 class 1
	A pie descalzo Barefoot slip resistance	B
	A pie calzado Slip resistance with footwear	<R9
	Resistencia al cuarteo Crazing resistance	si/yes
	Extrusión Extruded tiles	✓
	Resistencia a la helada Frost resistance	✓
	Resistencia al choque térmico Resistance to thermal shock	✓
	Resistencia química Chemical resistance	✓



Mytho Acero 33x33

MYTHO

ESMALTADOS
GLAZED TILES

Colores / Colors

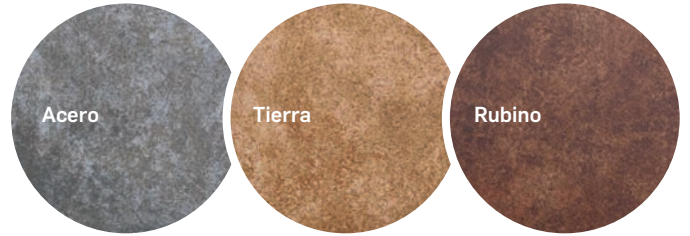

BASE 6x33* TILE 6x33*

[62x325x10 mm]

Acero Cod. 902333 [MC503]
Rubino Cod. 903034 [MC503]

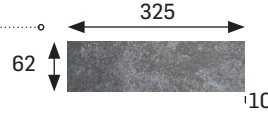

*Se obtiene a partir de base de 12x33 premarcada.
*It is obtained from 12x33 premarked tile.

BASE 33x33 TILE 33x33

[325x325x16 mm]

Acero Cod. 902586 [MC485]
Rubino Cod. 902576 [MC485]
Tierra Cod. 902566 [MC485]

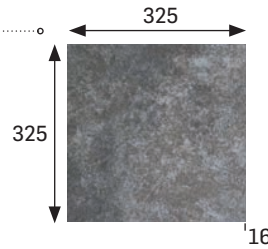

BASE 33x50 TILE 33x50

[325x492x16 mm]

Acero Cod. 902182 [MC510]
Rubino Cod. 902184 [MC510]
Tierra Cod. 902186 [MC510]

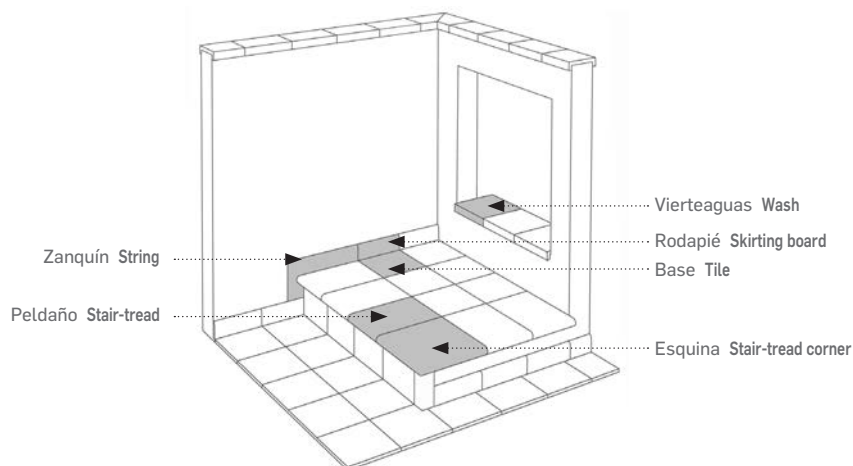
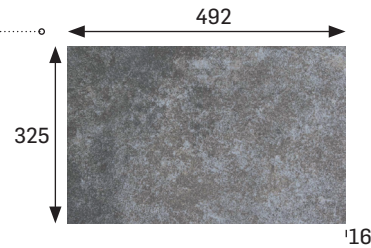

	Espesor (mm) Thickness (mm)	U.M.*	U.M./Caja U.M./Box	U.M./Palet U.M./Pallet	Pzs./U.M. Pcs./U.M.	Pzs./Caja Pcs./Box	Kg./U.M. Kg./U.M.	Kg./Caja Kg./Box	Kg./Palet Kg./Pallet
Base 6x33 (12x33 premarcada) Tile 6x33 (premarked tile 12x33)	10	m ² sqm	0,88	79,2	45,45	40	17,7	15,6	1404
Base 33x33 Tile 33x33	16	m ² sqm	0,666	42,624	9	6	32,6	21,75	1391
Base 33x50 Tile 33x50	16	m ² sqm	0,666	42,624	6	4	32,6	20,83	1348

* Unidad de Medida. Los artículos medidos en m² o ml se sirven contando la junta normal entre piezas.
* Unit of Measure. Items measured in sqm or lm are delivered assuming average joint between pieces.



Mytho Tierra 33x33

MYTHO

ESMALTADOS
GLAZED TILES

Colores / Colors



Acero

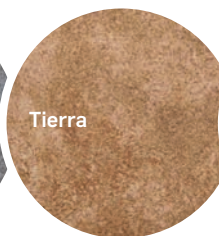

Tierra



Rubino



Mytho Rubino 33x33

	Espe- sor (mm) Thickness (mm)	U.M.*	U.M./Caja U.M./Box	U.M./Palet U.M./Pallet	Pzs./U.M. Pcs./U.M.	Pzs./Caja Pcs./Box	Kg./U.M. Kg./U.M.	Kg./Caja Kg./Box	Kg./Palet Kg./Pallet
Peldaño redondeado 33 Rounded stair-tread 33	18	Pz. Pc.	6	216	1	6	4,4	26,4	950
Peldaño redondeado 50 Rounded stair-tread 50	18	Pz. Pc.	4	144	1	4	6,94	27,7	1000
Esquina redondeada Rounded stair-tread corner	18	Pz. Pc.	2	60	1	2	6	12	360
Vierteaguas 33x33 Wash 33x33	18	Pz. Pc.	6	216	1	6	4,3	25,8	928,8
Rodapié Skirting board	16	ml lm	8	576	3	24	2,3	18,4	1325
Zanquín izda. String left	16	Pz. Pc.	10	300	1	10	1,3	13	390
Zanquín dcha. String right	16	Pz. Pc.	10	300	1	10	1,3	13	390
Tabica 12x33 Riser 12x33	16	Pz. Pc.	12**	-	1	12**	1,3	15,6	-
Rosetón 66x66 Mosaic 60x60	16	Jg. Set.	1	-	4	4	14,70	14,70	-

* Unidad de Medida. Los artículos medidos en m² o ml se sirven contando la junta normal entre piezas.
* Unit of Measure. Items measured in sqm or lm are delivered assuming average joint between pieces.

Anchura recomendada de la junta de colocación: 6 - 8 mm
Recommended joint width 6 - 8 mm

Piezas especiales Special pieces

PELDAÑO REDONDEADO 33

ROUNDED STAIR-TREAD 33

[325x330x18 mm]

Acero Cod. 902587 [PZ270]
Rubino Cod. 902577 [PZ270]
Tierra Cod. 902567 [PZ270]

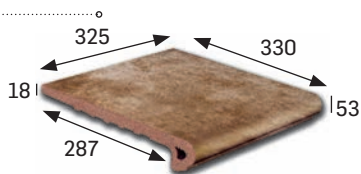

PELDAÑO REDONDEADO 50

ROUNDED STAIR-TREAD 50

[492x330x18 mm]

Acero Cod. 902183 [PZ355]
Rubino Cod. 902185 [PZ355]
Tierra Cod. 902187 [PZ355]

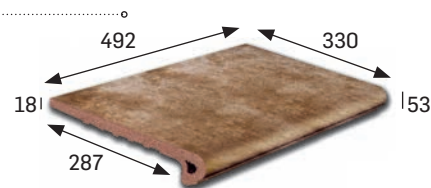

ESQUINA REDONDEADA

ROUNDED STAIR-TREAD CORNER

[330x330x18 mm]

Acero Cod. 902589 [PZ555]
Rubino Cod. 902579 [PZ555]
Tierra Cod. 902569 [PZ555]

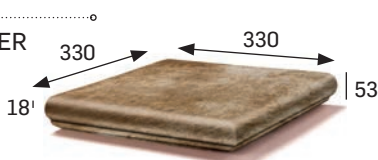

VIERTAGUAS 33X33

WASH 33X33

[330x325x18mm]

Acero Cod. 902592 [PZ245]
Rubino Cod. 902582 [PZ245]
Tierra Cod. 902572 [PZ245]

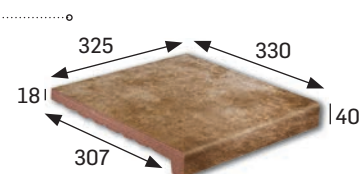

RODAPIÉ

SKIRTING BOARD

[325x80x16 mm]

Acero Cod. 902588 [ML160]
Rubino Cod. 902578 [ML160]
Tierra Cod. 902568 [ML160]

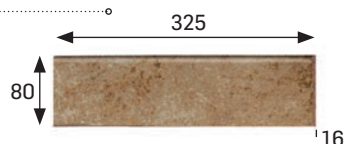

ZANQUÍN IZDA.

STRING LEFT SIDE

[390x80/200x100x16 mm]

Acero Cod. 902591 [PZ160]
Rubino Cod. 902581 [PZ160]
Tierra Cod. 902571 [PZ160]



ZANQUÍN DCHA.

STRING RIGHT SIDE

[390x80/200x100x16 mm]

Acero Cod. 902590 [PZ160]
Rubino Cod. 902580 [PZ160]
Tierra Cod. 902570 [PZ160]

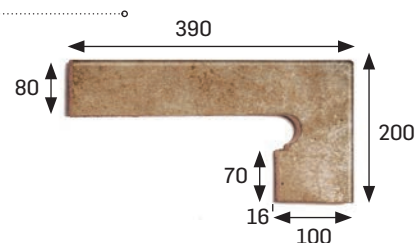

GEO

TABICA 12X33

RISER 12x33

[325x119x16 mm]

Tabica Tierra 12x33 Cod. 902995 [PZ240]
Tabica Acero 12x33 Cod. 902997 [PZ240]



Tabica Tierra



Tabica Acero

ROSETÓN 66X66

[650x650x16 mm]

Rosetón Acero 66x66 Cod. 902998 [JG735]
Rosetón Tierra 66x66 Cod. 902996 [JG735]



Rosetón Tierra

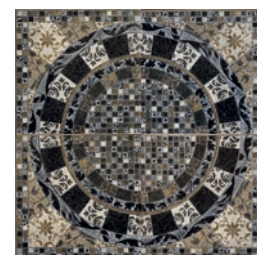

Rosetón Acero

Cada rosetón se compone de 4 piezas. / Each rosetón is composed of 4 pieces.

Decorados Decors

ESMALTADOS GLAZED TILES

CLASSIC

Colores / Colors

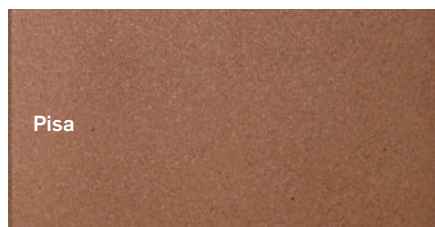
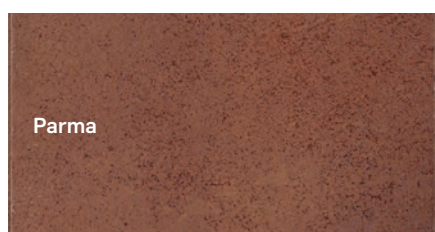
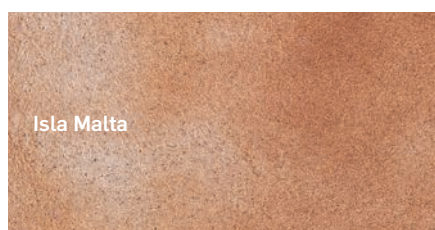
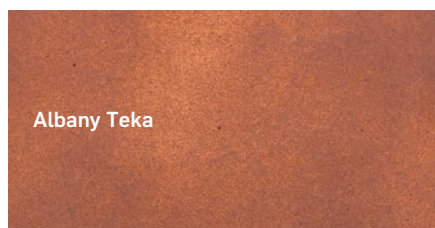

Los colores son indicativos.
Colors are just indicative.

















(cm) Formatos / Sizes

6x25

12x25

25x25

33x33

	ESMALTADO GLAZED	
	Características dimensionales Dimension tolerance	<1,25% máx 2 mm
	Absorción de agua Water absorption	3<E≤6%
	Coef. Dilatación térmica lineal Linear thermal expansion coefficient	3,8x10 ⁻⁶ xC ⁻¹
	Resistencia a la flexión Breaking Strength	20N/mm ²
	Resistencia a la abrasión superficial Resistance to surface abrasion	Teka/Parma/Pisa PEI 2 Malta PEI 3
	Desgaste tránsito peatonal Erosion to pedestrian transit	Malta H4
	Resistencia al rayado (Método Mohs) Scratch hardness of surface (Mohs Method)	Teka/Malta 8
	Resistencia a las manchas Resistance to stains	clase 5 class 5
	Péndulo (CTE) Not required out of Spain	Teka/Parma/Pisa 2 Malta 3
	A pie descalzo Barefoot slip resistance	Teka/Malta C
	A pie calzado Slip resistance with footwear	Teka R10 Pisa/Malta R11 Parma <R9
	Resistencia al cuarteo Crazing resistance	sí/yes
	Extrusión Extruded tiles	✓
	Resistencia a la helada Frost resistance	✓
	Resistencia al choque térmico Resistance to thermal shock	✓
	Resistencia química Chemical resistance	✓



Albany Teka 25x25

ESMALTADOS GLAZED TILES CLASSIC

Colores / Colors



BASE 6x25* TILE 6x25*

[62x244x10 mm]

Albany Teka	Cod. 902191 [MC480]
Isla Malta	Cod. 902948 [MC480]
Parma	Cod. 903832 [MC480]
Pisa	Cod. 903553 [MC480]

*Se obtiene a partir de base de 12x25 premarcada.
*It is obtained from 12x25 premarked tile.

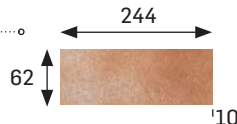

BASE 12x25 TILE 12x25

[119x244x14 mm]

Albany Teka	Cod. 901597 [MC425]
Isla Malta	Cod. 903831 [MC425]
Parma	Cod. 902831 [MC425]
Pisa	Cod. 901611 [MC425]

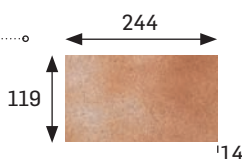

BASE 25x25 TILE 25x25

[244x244x14 mm]

Albany Teka	Cod. 900897 [MC425]
Isla Malta	Cod. 901211 [MC425]
Parma	Cod. 902830 [MC425]
Pisa	Cod. 901610 [MC425]

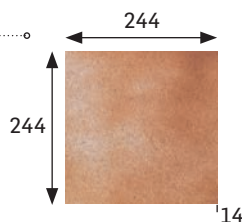

BASE 33x33 TILE 33x33

[325x325x16 mm]

Albany Teka	Cod. 901361 [MC485]
--------------------	---------------------

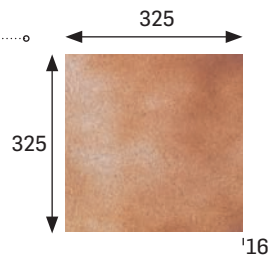

	Espesor (mm) Thickness (mm)	U.M.*	U.M./Caja U.M./Box	U.M./Palet U.M./Pallet	Pzs./U.M. Pcs./U.M.	Pzs./Caja Pcs./Box	Kg./U.M. Kg./U.M.	Kg./Caja Kg./Box	Kg./Palet Kg./Pallet
Base 6x25 (12x25 premarcada) Tile 6x25 (premarked tile 12x25)	10	m ² sqm	0,64	76,8	64	40	17	10,640	1276,8
Base 12x25 Tile 12x25	14	m ² sqm	0,50	60	32	16	25	12,5	1499
Base 25x25 Tile 25x25	14	m ² sqm	1	60	16	16	25	12,5	1499
Base 33x33 Tile 33x33	16	m ² sqm	0,666	42,624	9	6	32,6	21,75	1391

* Unidad de Medida. Los artículos medidos en m² o ml se sirven contando la junta normal entre piezas.
* Unit of Measure. Items measured in sqm or lm are delivered assuming average joint between pieces.



Albany Teka 25x25

ESMALTADOS GLAZED TILES

CLASSIC

Colores / Colors

Albany Teka

Isla Malta

Parma

Pisa



Parma 25x25

	Espesor (mm) Thickness (mm)	U.M.*	U.M./Caja U.M./Box	U.M./Palet U.M./Pallet	Pzs./U.M. Pcs./U.M.	Pzs./Caja Pcs./Box	Kg./U.M. Kg./U.M.	Kg./Caja Kg./Box	Kg./Palet Kg./Pallet
Peldaño redondeado 33 Rounded stair-tread 33	18	Pz. Pc.	6	216	1	6	4,4	26,4	950
Peldaño redondeado 25 Rounded stair-tread 25	18	Pz. Pc.	6	324	1	6	3,3	19,8	1069
Esquina redondeada Rounded stair-tread corner	18	Pz. Pc.	2	60	1	2	6	12	360
Vierteaguas 25x33 Wash 25x33	18	Pz. Pc.	6	324	1	6	3,13	18,78	1014
Rodapié 33 Skirting board 33	16	ml lm	8	576	3	24	2,3	18	1296
Rodapié 25 Skirting board 25	14	ml lm	11,25	450	4	45	2,5	27,7	1108
Zanquín izda. String left	16	Pz. Pc.	10	300	1	10	1,3	13	390
Zanquín dcha. String right	16	Pz. Pc.	10	300	1	10	1,3	13	390
Pasamanos 15,5 Handrail 15,5	18	Pz. Pc.	8	320	1	8	2,3	18,3	731
Ángulo fachada Facade angle	14	Pz. Pc.	16	896	1	16	1,19	14,6	876
Ángulo desigual Unequal edge	10	Pz. Pc.	12	720	1	12	1,2	12,2	732

* Unidad de Medida. Los artículos medidos en m² o ml se sirven contando la junta normal entre piezas.
* Unit of Measure. Items measured in sqm or lm are delivered assuming average joint between pieces.

Anchura recomendada de la junta de colocación: 6 - 8 mm
Recommended joint width 6 - 8 mm

Piezas especiales Special pieces

PELDAÑO REDONDEADO 33

ROUNDED STAIR-TREAD 33

[325x330x18 mm]

Albany Teka Cod. 901580 [PZ280]

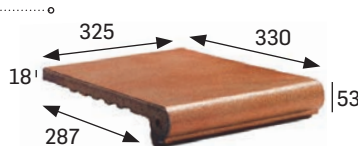

PELDAÑO REDONDEADO 25

ROUNDED STAIR-TREAD 25

[244x330x18 mm]

Albany Teka Cod. 900900 [PZ220]

Isla Malta Cod. 901212 [PZ220]

Parma Cod. 902832 [PZ220]

Pisa Cod. 901612 [PZ220]

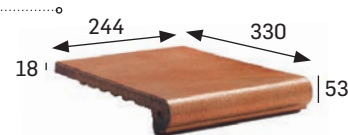

ESQUINA REDONDEADA

ROUNDED STAIR-TREAD CORNER

[330x330x18 mm]

Albany Teka Cod. 900901 [PZ555]

Isla Malta Cod. 901214 [PZ555]

Parma Cod. 902833 [PZ555]

Pisa Cod. 901617 [PZ555]

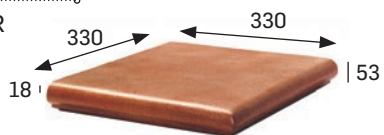

VIERTEAGUAS 25X33

WASH 25X33

[244x330x18 mm]

Albany Teka Cod. 900994 [PZ190]

Isla Malta Cod. 901217 [PZ190]

Parma Cod. 901399 [PZ190]

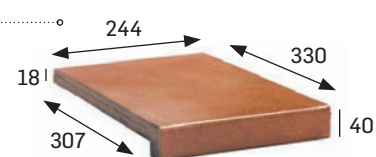

RODAPIÉ 33

SKIRTING BOARD 33

[325x80x16 mm]

Albany Teka Cod. 901582 [ML160]

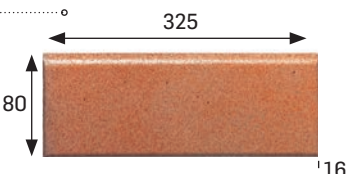

RODAPIÉ 25

SKIRTING BOARD 25

[244x80x14 mm]

Albany Teka Cod. 900904 [ML150]

Isla Malta Cod. 901213 [ML150]

Parma Cod. 902836 [ML150]

Pisa Cod. 901615 [ML150]

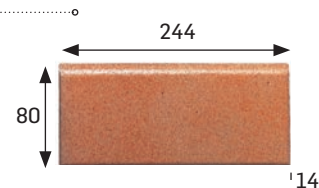

ZANQUÍN IZDA.

STRING LEFT SIDE

[390x80/200x100x16 mm]

Albany Teka Cod. 900903 [PZ160]

Isla Malta Cod. 901216 [PZ160]

Parma Cod. 902834 [PZ160]

Pisa Cod. 901613 [PZ160]

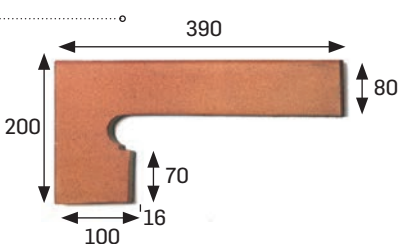

ZANQUÍN DCHA.

STRING RIGHT SIDE

[390x80/200x100x16 mm]

Albany Teka Cod. 900902 [PZ160]

Isla Malta Cod. 901215 [PZ160]

Parma Cod. 902835 [PZ160]

Pisa Cod. 901614 [PZ160]

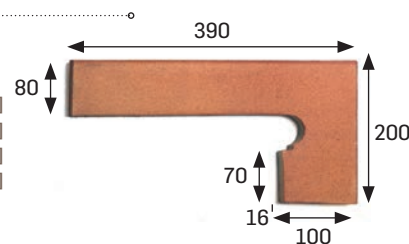

PASAMANOS 15,5

HANDRAIL 15,5

[244x191x40x18 mm]

Albany Teka Cod. 900950 [PZ170]

Isla Malta Cod. 901219 [PZ170]

Parma Cod. 901398 [PZ170]

Pisa Cod. 903929 [PZ170]

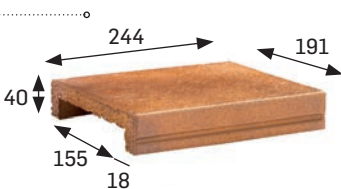

ÁNGULO FACHADA

FACADE ANGLE

[244x119x58x12 mm]

Albany Teka Cod. 901464 [PZ070]

Isla Malta Cod. 901467 [PZ070]

Parma Cod. 901396 [PZ070]

Pisa Cod. 904547 [PZ070]

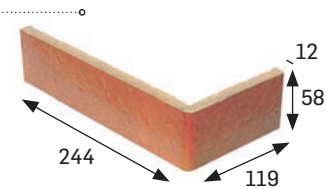

ÁNGULO DESIGUAL

UNEQUAL EDGE

[244x128x60x14 mm]

Albany Teka Cod. 900942 [PZ160]

Isla Malta Cod. 901397 [PZ160]

Parma Cod. 901594 [PZ160]

Pisa Cod. 901616 [PZ160]

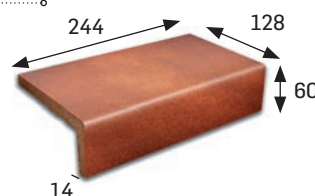

COLUMBIA

ESMALTADOS GLAZED TILES









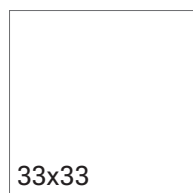







Colores / Colors



Los colores son indicativos.
Colors are just indicative.

(cm) Formatos / Sizes



	ESMALTADO GLAZED	
	Características dimensionales Dimension tolerance	<1,25% máx 2 mm
	Absorción de agua Water absorption	3<E≤6%
	Coef. Dilatación térmica lineal Linear thermal expansion coefficient	3,8x10 ⁻⁶ xC ⁻¹
	Resistencia a la flexión Breaking Strength	20N/mm ²
	Resistencia a la abrasión superficial Resistance to surface abrasion	PEI 3-4
	Desgaste tránsito peatonal Erosion to pedestrian transit	H4
	Resistencia a las manchas Resistance to stains	clase 5 class 5
	Péndulo (CTE) Not required out of Spain	clase 2 class 2
	A pie descalzo Barefoot slip resistance	B
	A pie calzado Slip resistance with footwear	R10
	Resistencia al cuarteo Crazing resistance	sí/yes
	Extrusión Extruded tiles	✓
	Resistencia a la helada Frost resistance	✓
	Resistencia al choque térmico Resistance to thermal shock	✓
	Resistencia química Chemical resistance	✓



Columbia Aguamarina 33x33

COLUMBIA

ESMALTADOS
GLAZED TILES

Colores / Colors

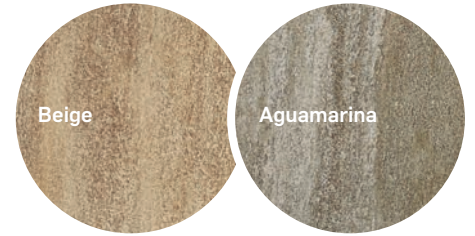

BASE 33x33 TILE 33x33

[325x325x16 mm]

Beige Cod. 901656 [MC510]
Aguamarina Cod. 901657 [MC510]

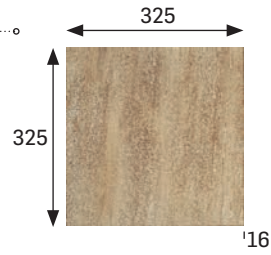

	Espesor (mm) Thickness (mm)	U.M.*	U.M./Caja U.M./Box	U.M./Palet U.M./Pallet	Pzs./U.M. Pcs./U.M.	Pzs./Caja Pcs./Box	Kg./U.M. Kg./U.M.	Kg./Caja Kg./Box	Kg./Palet Kg./Pallet
Base 33x33 Tile 33x33	16	m ² sqm	0,666	42,624	9	6	32,6	21,75	1391

* Unidad de Medida. Los artículos medidos en m² o ml se sirven contando la junta normal entre piezas.
* Unit of Measure. Items measured in sqm or lm are delivered assuming average joint between pieces.



Columbia Beige 38x33

COLUMBIA

ESMALTADOS
GLAZED TILES

Colores / Colors

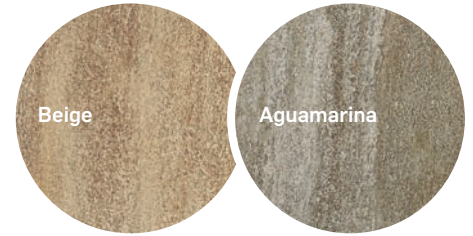

Columbia Beige 33x33

	Espesor (mm) Thickness (mm)	U.M.*	U.M./Caja U.M./Box	U.M./Palet U.M./Pallet	Pzs./U.M. Pcs./U.M.	Pzs./Caja Pcs./Box	Kg./U.M. Kg./U.M.	Kg./Caja Kg./Box	Kg./Palet Kg./Pallet
Peldaño redondeado 33 Rounded stair-tread 33	18	Pz. Pc.	6	216	1	6	4,4	26,4	950
Esquina redondeada Rounded stair-tread corner	18	Pz. Pc.	2	60	1	2	6	12	360
Rodapié Skirting board	16	ml lm	8	576	3	24	2,3	18,4	1325
Zanquín izda. String left	16	Pz. Pc.	10	300	1	10	1,3	13	390
Zanquín dcha. String right	16	Pz. Pc.	10	300	1	10	1,3	13	390
Borde desbordante Overflowing edge	22-26	Pz. Pc.	4	128	1	4	5	20	640
Esq. int. borde desbordante Overflowing internal edge	26	Jg. Set	2	-	2	4	8	16	-
Esq. ext. borde desbordante Overflowing external edge	26	Jg. Set	2	-	2	4	5,4	10,8	-
Rejilla cerámica monocompact Monocompact ceramic grid	25	Pz. Pc.	6	378	1	6	3,58	21,5	-
Esquina rejilla Corner grid	25	Set Set	3	-	2	6	4,69	14,07	-
Canaleta Overflow channel	30	Pz. Pc.	3	99	1	3	4,43	13,3	438,6

* Unidad de Medida. Los artículos medidos en m² o ml se sirven contando la junta normal entre piezas.
* Unit of Measure. Items measured in sqm or lm are delivered assuming average joint between pieces.

Anchura recomendada de la junta de colocación: 6 - 8 mm
Recommended joint width 6 - 8 mm

Piezas especiales Special pieces

PELDAÑO REDONDEADO 33

ROUNDED STAIR-TREAD 33
[325x330x18 mm]

Beige Cod. 901659 [PZ275]
Aguamarina Cod. 901660 [PZ275]

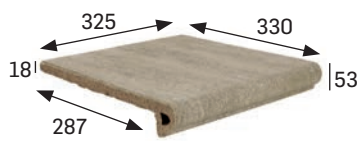

ESQUINA REDONDEADA

ROUNDED STAIR-TREAD CORNER
[330x330x18 mm]

Beige Cod. 901662 [PZ555]
Aguamarina Cod. 901663 [PZ555]

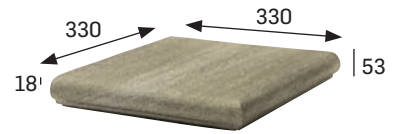

RODAPÍ

SKIRTING BOARD
[325x80x16 mm]

Beige Cod. 901671 [ML160]
Aguamarina Cod. 901672 [ML160]

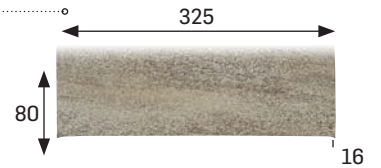

ZANQUÍN IZDA.

STRING LEFT SIDE
[390x80/200x100x16 mm]

Beige Cod. 901665 [PZ160]
Aguamarina Cod. 901666 [PZ160]

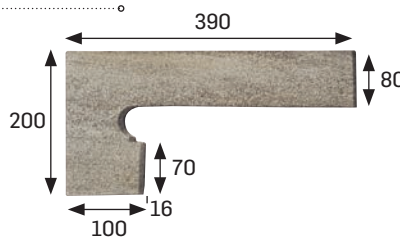

ZANQUÍN DCHA.

STRING RIGHT SIDE
[390x80/200x100x16 mm]

Beige Cod. 901668 [PZ160]
Aguamarina Cod. 901669 [PZ160]

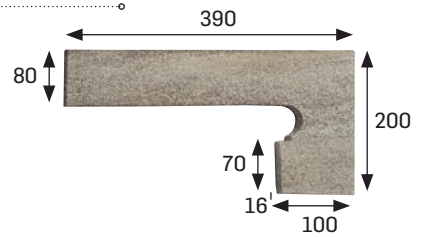

BORDE DESBORDANTE

OVERFLOWING EDGE
[325x330x26/22 mm]

Beige Cod. 901674 [PZ245]
Aguamarina Cod. 901675 [PZ245]

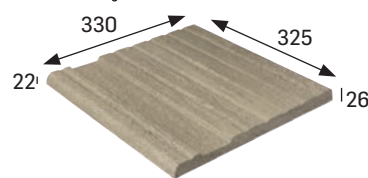

ESQ. INT. BORDE DESBORDANTE

OVERFLOWING INTERNAL EDGE
[330x444x119x26 mm]

Beige Cod. 901961 [JG395]
Aguamarina Cod. 901956 [JG395]

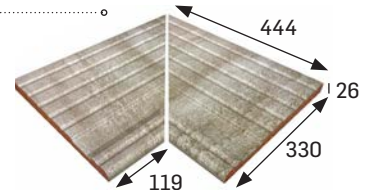

ESQ. EXT. BORDE DESBORDANTE

OVERFLOWING EXTERNAL EDGE
[330x353x26x22 mm]

Beige Cod. 901962 [JG395]
Aguamarina Cod. 901957 [JG395]

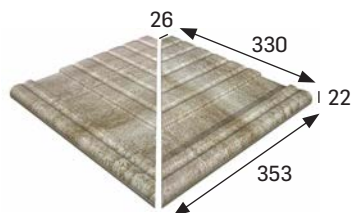

REJILLA CERÁMICA MONOCOMPACT

MONOCOMPACT CERAMIC GRID **
[325x244x25 mm]

Beige Cod. 902976 [PZ645]
Aguamarina Cod. 902977 [PZ645]

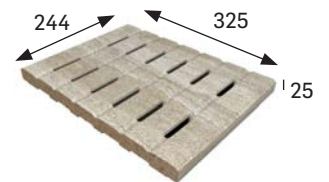

ESQUINA REJILLA

CORNER GRID **
[325x244x25x80 mm]

Beige Cod. 901494 [JG750]
Aguamarina Cod. 901493 [JG750]

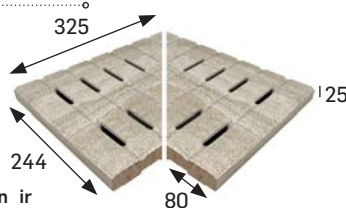

CANALETA

OVERFLOW CHANNEL *
[325x325x30 mm]

Beige Cod. 901894 [PZ250]
Aguamarina Cod. 901895 [PZ250]

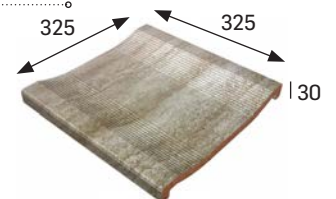

** En rejillas los agujeros siempre deben ir perpendiculares al vaso para una mayor resistencia, con canal de 250 mm de ancho.

** Install the grids with the holes always perpendicular to the pool vessel to get a greater resistance, with a channel 250 mm wide.

* Disponible Canaleta con desagüe.

* Overflow channel with drainage available.

ANTIC

ESMALTADOS GLAZED TILES









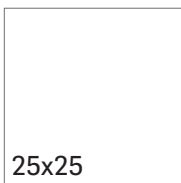







Colores / Colors



Los colores son indicativos.
Colors are just indicative.

(cm) Formatos / Sizes



	ESMALTADO GLAZED	
	Características dimensionales Dimension tolerance	<1,25% máx 2 mm
	Absorción de agua Water absorption	3<E≤6%
	Coef. Dilatación térmica lineal Linear thermal expansion coefficient	3,8x10 ⁻⁶ xC ⁻¹
	Resistencia a la flexión Breaking Strength	20N/mm ²
	Resistencia a la abrasión superficial Resistance to surface abrasion	Cuero, Marrón: PEI 3 Ceniza: PEI 4
	Resistencia a las manchas Resistance to stains	clase 5 class 5
	Péndulo (CTE) Not required out of Spain	clase 1 class 1
	A pie descalzo Barefoot slip resistance	B
	A pie calzado Slip resistance with footwear	R10
	Desgaste tránsito peatonal Erosion to pedestrian transit	H5
	Resistencia al cuarteo Crazing resistance	sí/yes
	Extrusión Extruded tiles	✓
	Resistencia a la helada Frost resistance	✓
	Resistencia al choque térmico Resistance to thermal shock	✓
	Resistencia química Chemical resistance	✓



Antic Ceniza 33x33

ANTIC

ESMALTADOS
GLAZED TILES

Colores / Colors



BASE 25x25 TILE 25x25

[244x244x14 mm]

Cuero Cod. 903937 [MC430]
Marrón Cod. 903938 [MC430]
Ceniza Cod. 903940 [MC430]

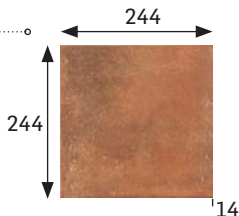

BASE 33x33 TILE 33x33

[325x325x16 mm]

Cuero Cod. 902890 [MC510]
Marrón Cod. 902904 [MC510]
Ceniza Cod. 902918 [MC510]

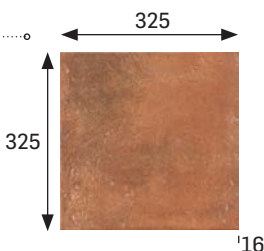

BASE DECORADOS 33x33 DECOR TILE 33x33

[325x325x16 mm]

Cuero Cod. 902896 [MC510]
Marrón Cod. 902910 [MC510]
Ceniza Cod. 902924 [MC510]

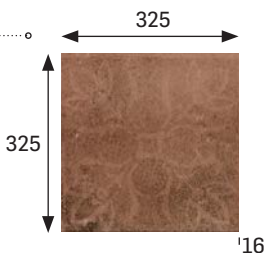

Decorado / Decor

	Espeor (mm) Thickness (mm)	U.M.*	U.M./Caja U.M./Box	U.M./Palet U.M./Pallet	Pzs./U.M. Pcs./U.M.	Pzs./Caja Pcs./Box	Kg./U.M. Kg./U.M.	Kg./Caja Kg./Box	Kg./Palet Kg./Pallet
Base 33x33 Tile 33x33	16	m ² sqm	0,666	42,624	9	6	32,6	21,75	1391
Base 25x25 Tile 25x25	14	m ² sqm	1	60	16	16	25	12,5	1499
Base decorados 33x33 Decor Tile 33x33	16	m ² sqm	0,666	42,624	9	6	32,6	21,75	1391

* Unidad de Medida. Los artículos medidos en m² o ml se sirven contando la junta normal entre piezas.

* Unit of Measure. Items measured in sqm or tm are delivered assuming average joint between pieces.



Antic Marrón 33x33

ANTIC

ESMALTADOS
GLAZED TILES

Colores / Colors



Cuero



Marrón



Ceniza



Antic Cuero 25x25



Antic Cuero

	Espesor (mm) Thickness (mm)	U.M.*	U.M./Caja U.M./Box	U.M./Palet U.M./Pallet	Pzs./U.M. Pcs./U.M.	Pzs./Caja Pcs./Box	Kg./U.M.	Kg./Caja Kg./Box	Kg./Palet Kg./Pallet
Peldaño redondeado 33 Rounded stair-tread 33	18	Pz. Pc.	6	216	1	6	4,4	26,4	950
Peldaño redondeado 25 Rounded stair-tread 25	18	Pz. Pc.	6	324	1	6	3,3	19,8	1069
Esquina redondeada Rounded stair-tread corner	18	Pz. Pc.	2	60	1	2	6	12	360
Rodapié 33 Skirting board 33	16	ml lm	8	576	3	24	2,3	18,4	1325
Rodapié 25 Skirting board 25	14	ml lm	11,25	450	4	45	2,5	27,7	1108
Zanquín izda. String left	16	Pz. Pc.	10	300	1	10	1,3	13	390
Zanquín dcha. String right	16	Pz. Pc.	10	300	1	10	1,3	13	390
Tabica 14x33 Riser 14x33	16	Pz. Pc.	12**	-	1	12**	1,6	19,4	-

* Unidad de Medida. Los artículos medidos en m² o ml se sirven contando la junta normal entre piezas.
* Unit of Measure. Items measured in sqm or lm are delivered assuming average joint between pieces.

Anchura recomendada de la junta de colocación: 6 - 8 mm
Recommended joint width 6 - 8 mm

** Consultar datos de embalaje con fábrica.
** Ask the factory for packing information.

Piezas especiales Special pieces

PELDAÑO REDONDEADO 33

ROUNDED STAIR-TREAD 33

[325x330x18 mm]

Cuero Cod. 902891 [PZ270]
Marrón Cod. 902905 [PZ270]
Ceniza Cod. 902919 [PZ270]

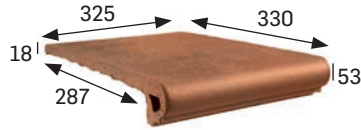

PELDAÑO REDONDEADO 25

ROUNDED STAIR-TREAD 25

[244x330x18 mm]

Cuero Cod. 903961 [PZ220]
Marrón Cod. 903962 [PZ220]
Ceniza Cod. 903964 [PZ220]

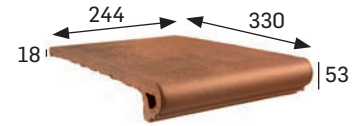

ESQUINA REDONDEADA

ROUNDED STAIR-TREAD CORNER

[330x330x18 mm]

Cuero Cod. 902892 [PZ555]
Marrón Cod. 902906 [PZ555]
Ceniza Cod. 902920 [PZ555]

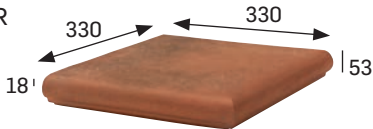

RODAPIÉ 33

SKIRTING BOARD 33

[325x80x16 mm]

Cuero Cod. 902893 [ML160]
Marrón Cod. 902907 [ML160]
Ceniza Cod. 902921 [ML160]



RODAPIÉ 25

SKIRTING BOARD 25

[244x80x14 mm]

Cuero Cod. 903965 [ML150]
Marrón Cod. 903966 [ML150]
Ceniza Cod. 903968 [ML150]



ZANQUÍN IZDA.

STRING LEFT SIDE

[390x80/200x100x16 mm]

Cuero Cod. 902894 [PZ160]
Marrón Cod. 902908 [PZ160]
Ceniza Cod. 902922 [PZ160]

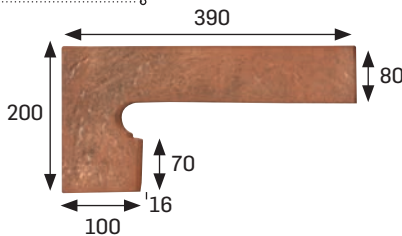

ZANQUÍN DCHA.

STRING RIGHT SIDE

[390x80/200x100x16 mm]

Cuero Cod. 902895 [PZ160]
Marrón Cod. 902909 [PZ160]
Ceniza Cod. 902923 [PZ160]

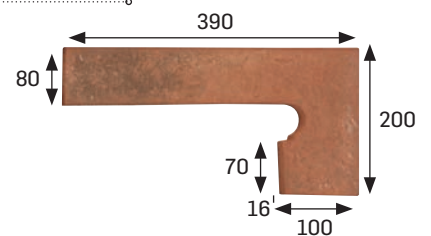

SPRING/BRICK

TABICA 14X33

RISER 14x33

[325x140x16 mm]

Brick Marrón 14x33 Cod. 902198 [PZ220]
Brick Gris 14x33 Cod. 902199 [PZ220]

* Varios diseños que se sirven mezclados.
 * Several models served mixed.



Tabica Brick Marrón 14x33*



Tabica Brick Gris 14x33*

Spring Marrón 14x33 Cod. 902196 [PZ220]
Spring Gris 14x33 Cod. 902197 [PZ220]



Tabica Spring Marrón 14x33



Tabica Spring Gris 14x33

Decorados Decors

STONE

ESMALTADOS GLAZED TILES









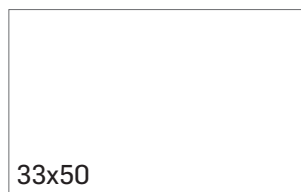
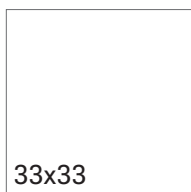





Colores / Colors



Los colores son indicativos.
Colors are just indicative.

(cm) Formatos / Sizes



	ESMALTADO GLAZED	
	Características dimensionales Dimension tolerance	<1,25% máx 2 mm
	Absorción de agua Water absorption	3<E≤6%
	Coef. Dilatación térmica lineal Linear thermal expansion coefficient	3,8x10 ⁻⁶ xC ⁻¹
	Resistencia a la flexión Breaking Strength	20N/mm ²
	Resistencia a la abrasión superficial Resistance to surface abrasion	Gris PEI 3 Beige PEI4
	Resistencia a las manchas Resistance to stains	clase 5 class 5
	Péndulo (CTE) Not required out of Spain	clase 2 class 2
	A pie descalzo Barefoot slip resistance	B
	A pie calzado Slip resistance with footwear	R10
	Resistencia al cuarteo Crazing resistance	sí/yes
	Extrusión Extruded tiles	✓
	Resistencia a la helada Frost resistance	✓
	Resistencia al choque térmico Resistance to thermal shock	✓
	Resistencia química Chemical resistance	✓



Stone Gris 33x50

STONE

ESMALTADOS
GLAZED TILES

Colores / Colors



BASE 33x33 TILE 33x33

[325x325x16 mm]

Beige Cod. 902961 [MC510]
Gris Cod. 902960 [MC510]



BASE DECORADOS 33x33 DECOR TILE 33x33

[325x325x16 mm]

Beige Cod. 902965 [MC510]
Gris Cod. 902964 [MC510]

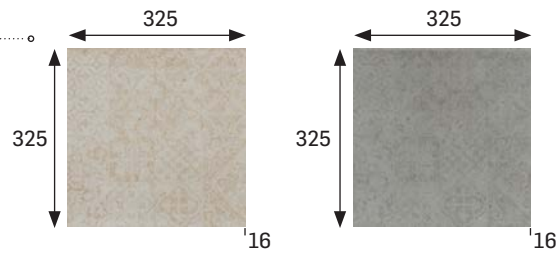

BASE 33x50 TILE 33x50

[325x492x16 mm]

Beige Cod. 902925 [MC555]
Gris Cod. 902932 [MC555]



BASE DECORADOS 33x50 DECOR TILE 33x50

[325x492x16 mm]

Beige Cod. 902931 [MC555]
Gris Cod. 902938 [MC555]

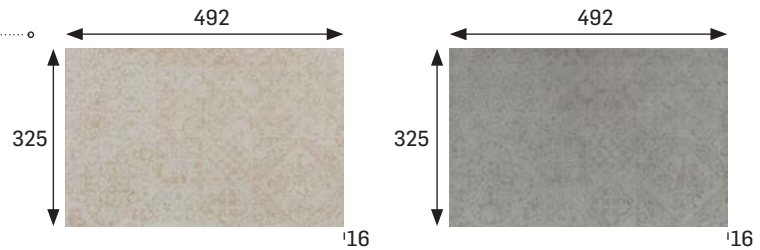

	Espesor (mm) Thickness (mm)	U.M.*	U.M./Caja U.M./Box	U.M./Palet U.M./Pallet	Pzs./U.M. Pcs./U.M.	Pzs./Caja Pcs./Box	Kg./U.M. Kg./U.M.	Kg./Caja Kg./Box	Kg./Palet Kg./Pallet
Base/decorados 33x33 Decor/Tile 33x33	16	m ² sqm	0,666	42,624	9	6	32,6	21,75	1391
Base/decorados 33x50 Decor/Tile 33x50	16	m ² sqm	0,66	42,624	6	4	31,26	20,83	1348

* Unidad de Medida. Los artículos medidos en m² o ml se sirven contando la junta normal entre piezas.
* Unit of Measure. Items measured in sqm or lm are delivered assuming average joint between pieces.



Stone Beige 33x50

STONE

ESMALTADOS
GLAZED TILES

Colores / Colors



Stone Beige

	Espe ^s or (mm) Thickness (mm)	U.M.*	U.M./Caja U.M./Box	U.M./Palet U.M./Pallet	Pzs./U.M. Pcs./U.M.	Pzs./Caja Pcs./Box	Kg./U.M. Kg./U.M.	Kg./Caja Kg./Box	Kg./Palet Kg./Pallet
Peldaño recto 50 Straight stair-tread 50	18	Pz. Pc.	4	144	1	4	6,33	25,3	911
Peldaño recto 33 Straight stair-tread 33	18	Pz. Pc.	6	216	1	6	4,6	27,6	994
Peldaño redondeado 33 Rounded stair-tread 33	18	Pz. Pc.	6	216	1	6	4,4	26,4	950
Esquina recta Straight stair-tread corner	18	Pz. Pc.	2	60	1	2	5,07	10,15	319
Esquina redondeada Rounded stair-tread corner	18	Pz. Pc.	2	60	1	2	6	12	360
Rodapié Skirting board	16	ml lm	8	576	3	24	2,3	18,4	1325
Zanquín izda. String left	16	Pz. Pc.	10	300	1	10	1,3	13	390
Zanquín dcha. String right	16	Pz. Pc.	10	300	1	10	1,3	13	390
Zanquín izda. recto Straight string left	16	Pz. Pc.	10	300	1	10	1,3	13	390
Zanquín dcha. recto Straight string right	16	Pz. Pc.	10	300	1	10	1,3	13	390

* Unidad de Medida. Los artículos medidos en m² o ml se sirven contando la junta normal entre piezas.
* Unit of Measure. Items measured in sqm or lm are delivered assuming average joint between pieces.

Anchura recomendada de la junta de colocación: 6 - 8 mm
Recommended joint width 6 - 8 mm

Piezas especiales Special pieces

PELDAÑO RECTO 50
STRAIGHT STAIR-TREAD 50
[492x330x18 mm]

Beige Cod. 902926 [PZ355]
Gris Cod. 902933 [PZ355]

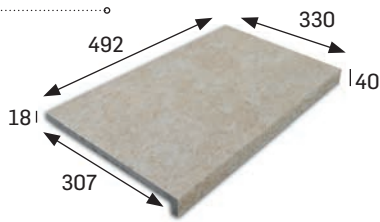

PELDAÑO RECTO 33
STRAIGHT STAIR-TREAD 33
[330x325x40x18 mm]

Beige Cod. 902963 [PZ275]
Gris Cod. 902962 [PZ275]



PELDAÑO REDONDEADO 33
ROUNDED STAIR-TREAD 33
[330x330x18 mm]

Beige Cod. 901510 [PZ270]
Gris Cod. 903548 [PZ270]

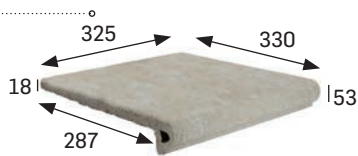

ESQUINA RECTA
STAIR-TREAD CORNER
[330x330x40x18 mm]

Beige Cod. 902927 [PZ555]
Gris Cod. 902934 [PZ555]

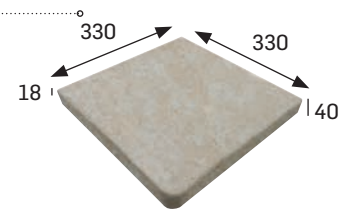

ESQUINA REDONDEADA
ROUNDED STAIR-TREAD CORNER
[330x330x18 mm]

Beige Cod. 901511 [PZ555]
Gris Cod. 903549 [PZ555]

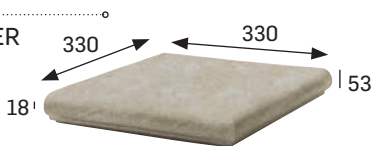

RODAPIÉ
SKIRTING BOARD
[325x80x16 mm]

Beige Cod. 902928 [ML160]
Gris Cod. 902935 [ML160]



ZANQUÍN IZDA.
STRING LEFT SIDE
[390x80/200x100x16 mm]

Beige Cod. 904124 [PZ160]
Gris Cod. 904125 [PZ160]

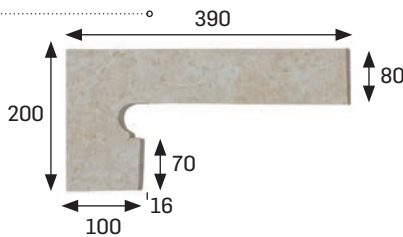

ZANQUÍN DCHA.
STRING RIGHT SIDE
[390x80/200x100x16 mm]

Beige Cod. 904126 [PZ160]
Gris Cod. 904127 [PZ160]

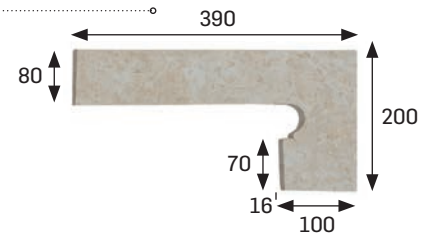

ZANQUÍN IZDA. RECTO
STRAIGHT STRING LEFT SIDE *
[390x80/200x100x16 mm]

Beige Cod. 902929 [PZ160]
Gris Cod. 902936 [PZ160]

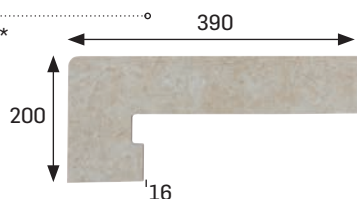

ZANQUÍN DCHA. RECTO
STRAIGHT STRING RIGHT SIDE *
[390x80/200x100x16 mm]

Beige Cod. 902930 [PZ160]
Gris Cod. 902937 [PZ160]



* Sólo combina con los peldaños rectos 50 y 33.









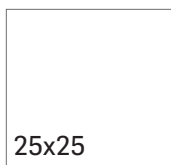







* It only matches with Straight stair-tread 50 and 33.

RETRO ALCÁZAR

ESMALTADOS GLAZED TILES

(cm) Formatos / Sizes



		 ESMALTADO GLAZED
	Características dimensionales Dimension tolerance	<1,25% máx 2 mm
	Absorción de agua Water absorption	3<E≤6%
	Coef. Dilatación termica lineal Linear thermal expansion coefficient	3,8x10 ⁻⁶ xC ⁻¹
	Resistencia a la flexión Breaking Strength	20 N/mm ²
	Resistencia a la abrasión superficial Resistance to surface abrasion	PEI 4
	Resistencia a la abrasión profunda Resistance to deep abrasion	
	Resistencia a las manchas Resistance to stains	clase 5 class 5
	Péndulo (CTE) Not required out of Spain	clase 1 class 1
	A pie descalzo Barefoot slip resistance	B
	A pie calzado Slip resistance with footwear	R9
	Resistencia al cuarteo Crazing resistance	sí/yes
	Extrusión Extruded tiles	✓
	Resistencia a la helada Frost resistance	✓
	Resistencia al choque térmico Resistance to thermal shock	✓
	Resistencia química Chemical resistance	✓



Retro Blanco 33x33

RETRO

ESMALTADOS
GLAZED TILES

BASE 25x25 TILE 25x25**

[244x244x14 mm]

Retro Azul Cod. 901700 [MC455]

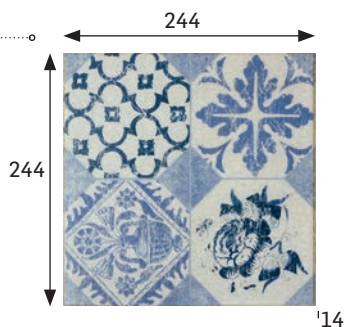

Retro Azul**

** Composición de varias piezas 25x25.

Several 25x25 pieces composition.

** Varios diseños que se sirven mezclados.

We supply several models mixed.

TABICA 12X25*

RISER 12x25
[244x119x14 mm]

Retro Azul Blue Retro 12x25
Cod. 901719 [PZ035]



Retro Azul*

TABICA 12X33*

RISER 12x33
[325x119x16 mm]

Retro Azul Blue Retro 12x33
Cod. 904620 [PZ050]



Retro Azul*

* Varios diseños que se sirven mezclados.
* we supply several models mixed.

BASE 33x33 TILE 33x33

[325x325x16 mm]

- Retro blanco 0** Cod. 901738 [MC530]
- Retro blanco 1** Cod. 901685 [MC530]
- Retro blanco 2** Cod. 901686 [MC530]
- Retro blanco 3** Cod. 901687 [MC530]
- Retro blanco 4** Cod. 901688 [MC530]
- Retro blanco 5** Cod. 901689 [MC530]
- Retro blanco 6** Cod. 901690 [MC530]
- Retro blanco 7** Cod. 901691 [MC530]
- Retro blanco 8** Cod. 901692 [MC530]
- Retro blanco 9** Cod. 901693 [MC530]
- Retro blanco 10** Cod. 901694 [MC530]

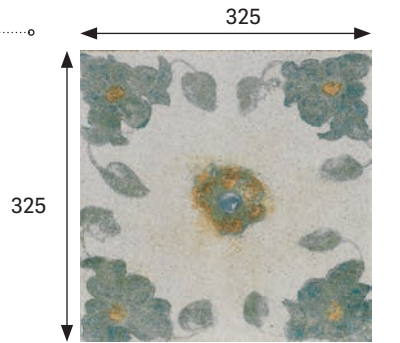

'16



Retro blanco 0



Retro blanco 1



Retro blanco 2



Retro blanco 3



Retro blanco 4

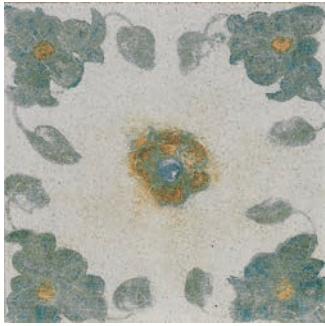

Retro blanco 5



Retro blanco 6



Retro blanco 7



Retro blanco 8



Retro blanco 9

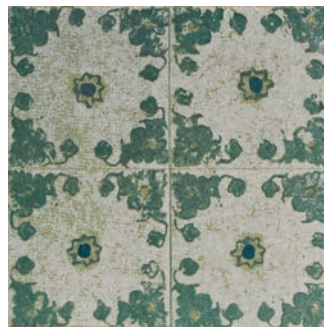

Retro blanco 10

	Espeor (mm) Thickness (mm)	U.M.*	U.M./Caja U.M./Box	U.M./Palet U.M./Pallet	Pzs./U.M. Pcs./U.M.	Pzs./Caja Pcs./Box	Kg./U.M. Kg./U.M.	Kg./Caja Kg./Box	Kg./Palet Kg./Pallet
Retro 25x25 Retro 25x25	14	m ² sqm	1	60	16	16	26	26	1560
Retro Blanco 0/10 33x33 Retro Blanco 0/10 33x33	16	m ² sqm	0,666	42,624	9	6	32,6	21,75	1391
Tabica Retro 12x25 Riser 12x25	14	Pz. Pc.	16	1920	1	16	0,79	12,64	1516,8
Tabica Retro 12x33 Riser 12x33	16	Pz. Pc.	16	640	1	16	1,12	17,92	716,80

ALCÁZAR

ESMALTADOS
GLAZED TILES

BASE 33x33 TILE 33x33

[325x325x16 mm]

Alcázar 1	Cod. 902153	[MC530]
Alcázar 2	Cod. 902154	[MC530]
Alcázar 3	Cod. 902155	[MC530]
Alcázar 4	Cod. 902156	[MC530]

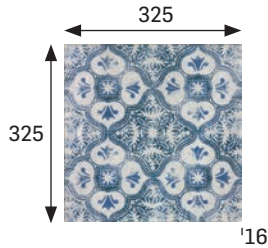

Alcázar 1



Alcázar 2



Alcázar 3

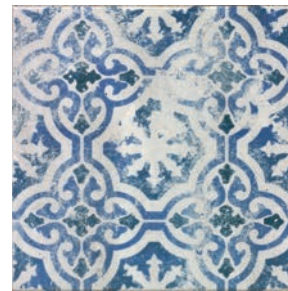

Alcázar 4

ROSETÓN 66x66

[650x650x16 mm]

Rosetón Alcázar Cod. 902157 [JG360]

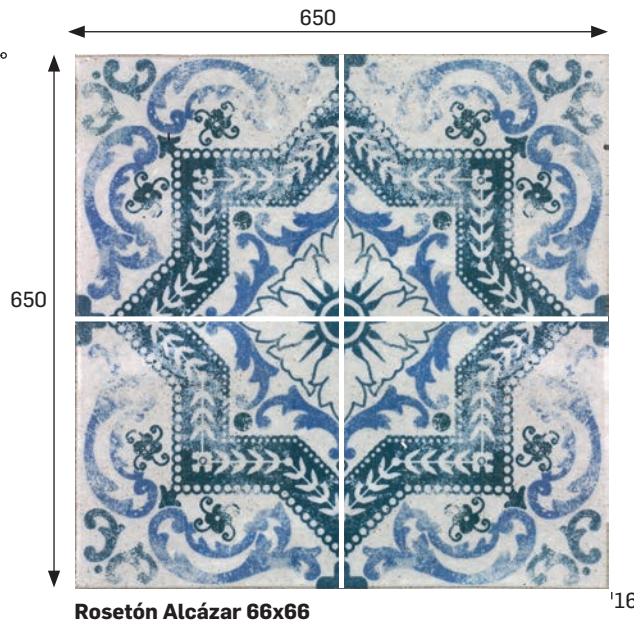

Rosetón Alcázar 66x66

108

PAVIMENTOS FLOOR TILES

	Espesor (mm) Thickness (mm)	U.M.*	U.M./Caja U.M./Box	U.M./Palet U.M./Pallet	Pzs./U.M. Pcs./U.M.	Pzs./Caja Pcs./Box	Kg./U.M. Kg./U.M.	Kg./Caja Kg./Box	Kg./Palet Kg./Pallet
Alcázar 1/4 33x33 Alcázar 1/4 33x33	16	m ² sqm	0,666	42,624	9	6	32,6	21,75	1391
Rosetón Alcázar 66x66 Rosetón Alcázar 66x66	16	Jg set	1	-	4	4	14,5	14,5	-

* Unidad de Medida. Los artículos medidos en m² o ml se sirven contando la junta normal entre piezas.

* Unit of Measure. Items measured in sqm or lm are delivered assuming average joint between pieces.



Alcázar 3 33x33



Alcázar 33x33

ORIÓN

NATURALES NATURAL TILES



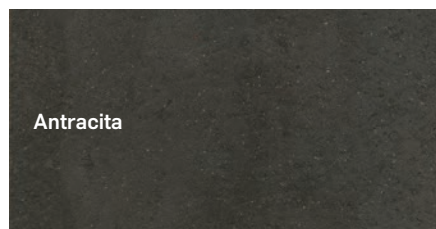
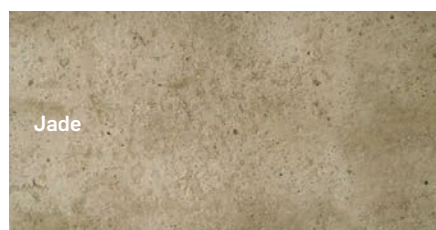
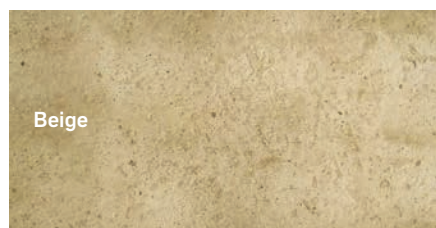





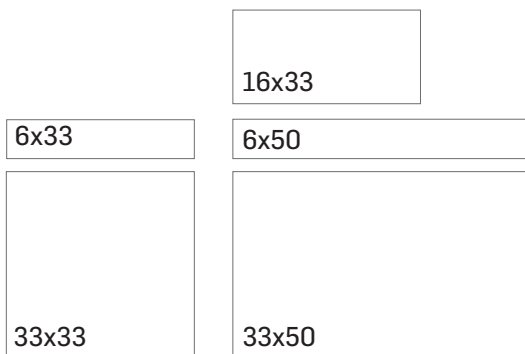





Colores / Colors



Los colores son indicativos.
Colors are just indicative.

(cm) Formatos / Sizes



	ESMALTADO GLAZED	
	Características dimensionales Dimension tolerance	<1,25% máx 2 mm
	Absorción de agua Water absorption	3<E≤6%
	Coef. Dilatación térmica lineal Linear thermal expansion coefficient	3,8x10 ⁻⁶ xC ⁻¹
	Resistencia a la flexión Breaking Strength	20 N/mm ²
	Resistencia a la abrasión superficial Resistance to surface abrasion	Beige/Jade PEI4 Gris PEI3 Antracita PEI2
	Resistencia a las manchas Resistance to stains	clase 5 class 5
	Péndulo (CTE) Not required out of Spain	clase 2 class 2
	A pie descalzo Barefoot slip resistance	C
	A pie calzado Slip resistance with footwear	R11
	Extrusión Extruded tiles	✓
	Resistencia a la helada Frost resistance	✓
	Resistencia al choque térmico Resistance to thermal shock	✓
	Resistencia química Chemical resistance	✓



Orión Antracita multiformato

ORIÓN

NATURALES
NATURAL TILES

Colores / Colors

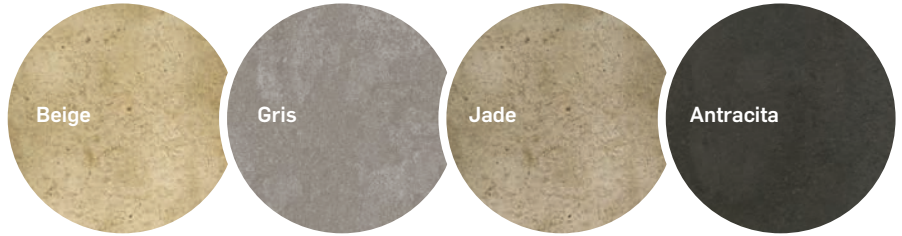

BASE 6x33 TILE 6x33*

[62x325x10 mm]

Beige Cod. 904478 [MC560]
Gris Cod. 904474 [MC560]
Jade Cod. 904477 [MC560]
Antracita Cod. 904605 [MC560]

*Se obtiene a partir de base de 33x33 premarcada.
*It is obtained from 33x33 premarked tile.



BASE 6x50 TILE 6x50

[62x492x10 mm]

Beige Cod. 905779 [MC570]
Gris Cod. 905780 [MC570]
Jade Cod. 905781 [MC570]
Antracita Cod. 905782 [MC570]

*Se obtiene a partir de base de 33x50 premarcada.
*It is obtained from 33x50 premarked tile.

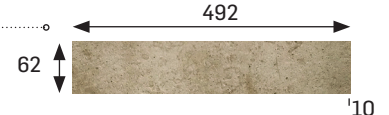

BASE 16x33 TILE 16x33

[159x325x16 mm]

Beige Cod. 903970 [MC510]
Gris Cod. 904190 [MC510]
Jade Cod. 903977 [MC510]
Antracita Cod. 904604 [MC510]

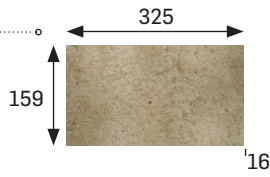

BASE 33x50 TILE 33x50

[325x492x16 mm]

Beige Cod. 904476 [MC555]
Gris Cod. 904472 [MC555]
Jade Cod. 904475 [MC555]
Antracita Cod. 904603 [MC555]

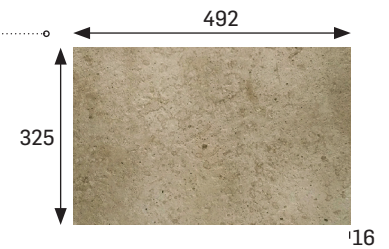

BASE 33x33 TILE 33x33

[325x325x16 mm]

Beige Cod. 903969 [MC510]
Gris Cod. 904189 [MC510]
Jade Cod. 903976 [MC510]
Antracita Cod. 904602 [MC510]

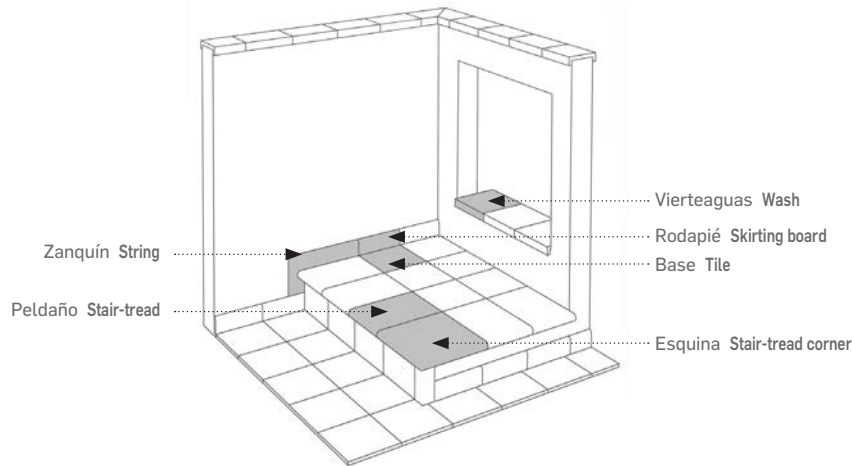
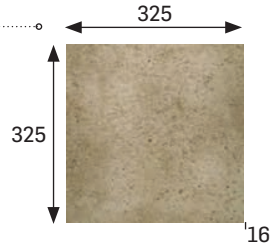

	Espesor (mm) Thickness (mm)	U.M.*	U.M./Caja U.M./Box	U.M./Palet U.M./Pallet	Pzs./U.M. Pcs./U.M.	Pzs./Caja Pcs./Box	Kg./U.M. Kg./U.M.	Kg./Caja Kg./Box	Kg./Palet Kg./Pallet
Base 6x33 (12x33 premarcada) Tile 6x33 (premarked tile 12x33)	10	m ² sqm	0,88	79,2	45,45	40	17,7	15,6	1404
Base 16x33 Tile 16x33	16	m ² sqm	0,68	40	18	12	30,6	20,4	1225
Base 33x33 Tile 33x33	16	m ² sqm	0,666	42,624	9	6	32,6	21,75	1391
Base 6x50 (12x50 premarcada) Tile 6x50 (premarked tile 12x50)	10	m ² sqm	0,99	69,3	30,3	30	17,6	17,4	1218
Base 33x50 Tile 33x50	16	m ² sqm	0,666	42,624	6	4	32,6	20,83	1348

* Unidad de Medida. Los artículos medidos en m² o ml se sirven contando la junta normal entre piezas.
* Unit of Measure. Items measured in sqm or lm are delivered assuming average joint between pieces.



Orión Gris 33x33 y 33x50

ORIÓN

NATURALES
NATURAL TILES

Colores / Colors

Beige

Gris

Jade

Antracita



Orión Beige 33x33



Orión Jade

	Espesor (mm) Thickness (mm)	U.M.*	U.M./Caja U.M./Box	U.M./Palet U.M./Pallet	Pzs./U.M. Pcs./U.M.	Pzs./Caja Pcs./Box	Kg./U.M. Kg./U.M.	Kg./Caja Kg./Box	Kg./Palet Kg./Pallet
Peldaño redondeado 33 Rounded stair-tread 33	18	Pz. Pc.	6	216	1	6	4,4	26,4	950
Peldaño redondeado 50 Rounded stair-tread 50	18	Pz. Pc.	4	144	1	4	6,94	27,7	1000
Peldaño recto 50 Straight stair-tread 50	18	Pz. Pc.	4	144	1	4	6,33	25,3	911
Esquina redondeada Rounded stair-tread corner	18	Pz. Pc.	2	60	1	2	6	12	360
Rodapié Skirting board	16	ml lm	8	576	3	24	2,3	18,4	1325
Zanquín izda. String left	16	Pz. Pc.	10	300	1	10	1,3	13	390
Zanquín dcha. String right	16	Pz. Pc.	10	300	1	10	1,3	13	390
Rejilla cerámica monocompact Monocompact ceramic grid	25	Pz. Pc.	6	378	1	6	3,58	21,5	-
Esquina rejilla Corner grid	25	Set Set	3	-	2	6	4,69	14,07	-

* Unidad de Medida. Los artículos medidos en m² o ml se sirven contando la junta normal entre piezas.
* Unit of Measure. Items measured in sqm or lm are delivered assuming average joint between pieces.

Anchura recomendada de la junta de colocación: 6 - 8 mm
Recommended joint width 6 - 8 mm

Piezas especiales Special pieces

PELDAÑO REDONDEADO 33

ROUNDED STAIR-TREAD 33
[325x330x18 mm]

Beige	Cod. 903971	[PZ270]
Gris	Cod. 904480	[PZ270]
Jade	Cod. 903978	[PZ270]
Antracita	Cod. 904606	[PZ270]

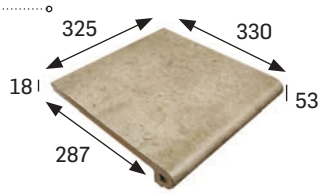

PELDAÑO REDONDEADO 50

ROUNDED STAIR-TREAD 50
[492x330x18 mm]

Beige	Cod. 904492	[PZ355]
Gris	Cod. 904481	[PZ355]
Jade	Cod. 904488	[PZ355]
Antracita	Cod. 904607	[PZ355]



PELDAÑO RECTO 50

STRAIGHT STAIR-TREAD 50
[492x330x18 mm]

Beige	Cod. 904493	[PZ355]
Gris	Cod. 904482	[PZ355]
Jade	Cod. 904489	[PZ355]
Antracita	Cod. 904608	[PZ355]

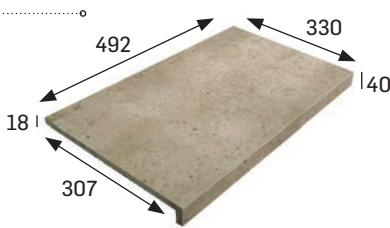

ESQUINA REDONDEADA

ROUNDED STAIR-TREAD CORNER
[330x330x18 mm]

Beige	Cod. 903972	[PZ555]
Gris	Cod. 904483	[PZ555]
Jade	Cod. 903979	[PZ555]
Antracita	Cod. 904609	[PZ555]

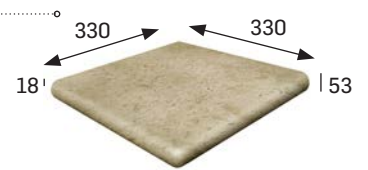

RODAPIÉ

SKIRTING BOARD
[325x80x16 mm]

Beige	Cod. 903975	[ML160]
Gris	Cod. 904479	[ML160]
Jade	Cod. 903982	[ML160]
Antracita	Cod. 904612	[ML160]

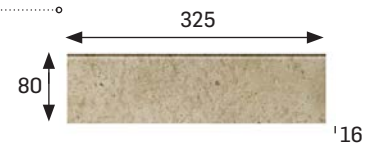

ZANQUÍN IZDA.

STRING LEFT SIDE
[390x80/200x100x16 mm]

Beige	Cod. 903973	[PZ160]
Gris	Cod. 904485	[PZ160]
Jade	Cod. 903980	[PZ160]
Antracita	Cod. 904611	[PZ160]

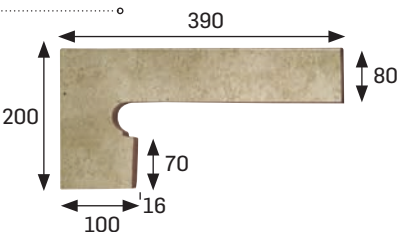

ZANQUÍN DCHA.

STRING RIGHT SIDE
[390x80/200x100x16 mm]

Beige	Cod. 903974	[PZ160]
Gris	Cod. 904484	[PZ160]
Jade	Cod. 903981	[PZ160]
Antracita	Cod. 904610	[PZ160]

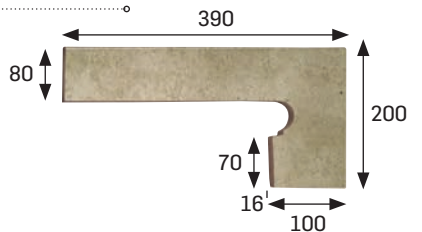

REJILLA CERÁMICA MONOCOMPACT

MONOCOMPACT CERAMIC GRID **
[325x244x25 mm]

Beige	Cod. 904494	[PZ645]
Gris	Cod. 904486	[PZ645]
Jade	Cod. 904490	[PZ645]
Antracita	Cod. 904613	[PZ645]

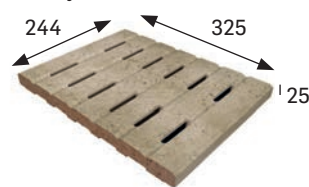

ESQUINA REJILLA

CORNER GRID **
[325x244x25x80 mm]

Beige	Cod. 904495	[JG750]
Gris	Cod. 904487	[JG750]
Jade	Cod. 904491	[JG750]
Antracita	Cod. 904614	[JG750]

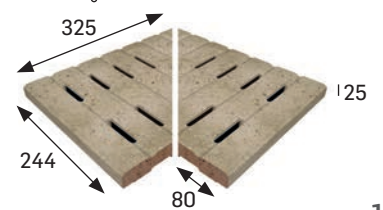

** En rejillas los agujeros siempre deben ir perpendiculares al vaso para una mayor resistencia, con canal de 250 mm de ancho.

** Install the grids with the holes always perpendicular to the pool vessel to get a greater resistance, with a channel 250 mm wide.

CAPRI

ESMALTADOS GLAZED TILES

Colores / Colors



Beige

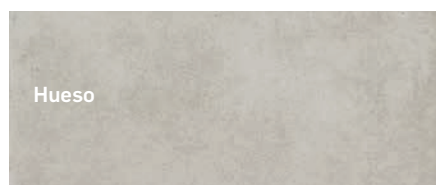

Hueso



Gris

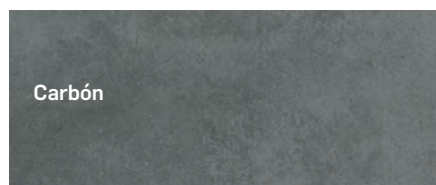

Carbón

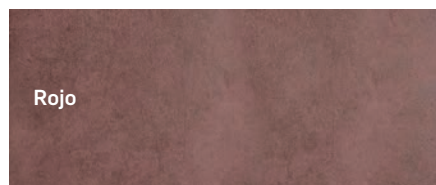

Rojo

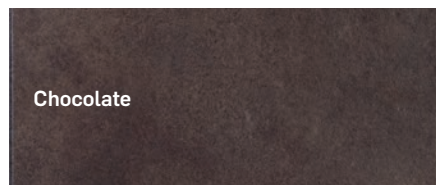

Chocolate

Los colores son indicativos.
Colors are just indicative.

116

PAVIMENTOS FLOOR TILES

(cm) Formatos / Sizes

6x33

33x33

16x33

6x50

33x50



ESMALTADO
GLAZED



Características dimensionales
Dimension tolerance

<1,25%
máx 2 mm



Absorción de agua
Water absorption

3<E≤6%



Coef. Dilatación térmica lineal
Linear thermal expansion coefficient

3,8x10⁻⁶xC⁻¹



Resistencia a la flexión
Breaking Strength

20N/mm²



Resistencia a la abrasión superficial
Resistance to surface abrasion

Gris PEI 3
Beige, Hueso, Carbón,
Rojo, Chocolate PEI 4



Desgaste tránsito peatonal
Erosion to pedestrian transit

H4



Resistencia a las manchas
Resistance to stains

clase 5
class 5



Péndulo (CTE)
Not required out of Spain

clase 2
class 2



A pie descalzo
Barefoot slip resistance

B



A pie calzado
Slip resistance with footwear

R10



Resistencia al cuarteo
Crazing resistance

sí/yes



Extrusión
Extruded tiles

✓



Resistencia a la helada
Frost resistance

✓



Resistencia al choque térmico
Resistance to thermal shock

✓



Resistencia química
Chemical resistance

✓



Capri Beige multiformato



Capri Rojo 33x33

CAPRI

Colores / Colors

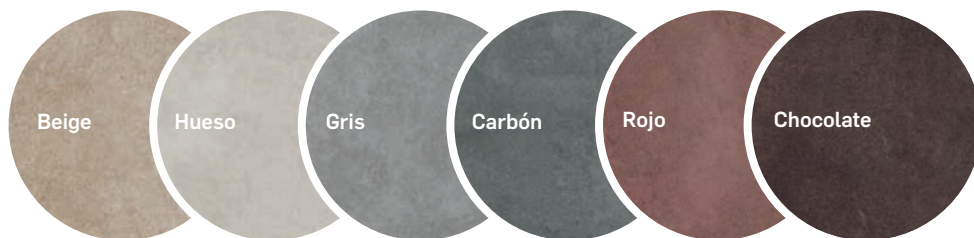

ESMALTADOS
GLAZED TILES

BASE 6x33 TILE 6x33*

[62x325x10 mm]

Beige	Cod. 905068 [MC560]
Hueso	Cod. 905069 [MC560]
Gris	Cod. 905070 [MC560]
Carbón	Cod. 905071 [MC560]
Rojo	Cod. 905648 [MC560]
Chocolate	Cod. 905141 [MC560]

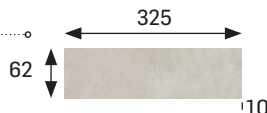

*Se obtiene a partir de base de 33x33 premarcada.
*It is obtained from 33x33 premarked tile.

BASE 16x33 TILE 16x33

[159x325x16 mm]

Beige	Cod. 905072 [MC510]
Hueso	Cod. 905073 [MC510]
Gris	Cod. 905074 [MC510]
Carbón	Cod. 905075 [MC510]
Rojo	Cod. 905649 [MC510]
Chocolate	Cod. 905142 [MC510]

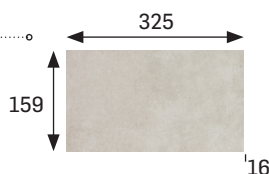

BASE 33x33 TILE 33x33

[325x325x16 mm]

Beige	Cod. 905076 [MC510]
Hueso	Cod. 905077 [MC510]
Gris	Cod. 905078 [MC510]
Carbón	Cod. 905079 [MC510]
Rojo	Cod. 905650 [MC510]
Chocolate	Cod. 905143 [MC510]

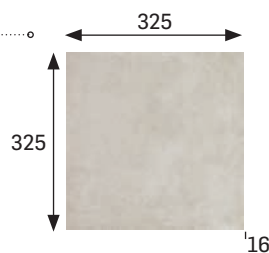

BASE 6x50 TILE 6x50*

[62x492x10 mm]

Beige	Cod. 905123 [MC570]
Hueso	Cod. 905124 [MC570]
Gris	Cod. 905125 [MC570]
Carbón	Cod. 905126 [MC570]
Rojo	Cod. 905784 [MC570]
Chocolate	Cod. 905783 [MC570]



*Se obtiene a partir de base de 33x50 premarcada.
*It is obtained from 33x50 premarked tile.

BASE 33x50 TILE 33x50

[325x492x16 mm]

Beige	Cod. 905080 [MC555]
Hueso	Cod. 905081 [MC555]
Gris	Cod. 905082 [MC555]
Carbón	Cod. 905083 [MC555]
Rojo	Cod. 905651 [MC555]
Chocolate	Cod. 905144 [MC555]

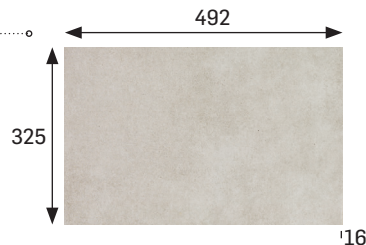

	Espesor (mm) Thickness (mm)	U.M.*	U.M./Caja U.M./Box	U.M./Palet U.M./Pallet	Pzs./U.M. Pcs./U.M.	Pzs./Caja Pcs./Box	Kg./U.M. Kg./U.M.	Kg./Caja Kg./Box	Kg./Palet Kg./Pallet
Base 6x33 (12x33 premarcada) Tile 6x33 (premarked tile 12x33)	10	m ² sqm	0,88	79,2	45,45	40	17,7	15,6	1404
Base 16x33 Tile 16x33	16	m ² sqm	0,68	40	18	12	30,6	20,4	1225
Base 33x33 Tile 33x33	16	m ² sqm	0,666	42,624	9	6	32,6	21,75	1391
Base 6x50 (12x50 premarcada) Tile 6x50 (premarked tile 12x50)	10	m ² sqm	0,99	69,3	30,3	30	17,6	17,4	1218
Base 33x50 Tile 33x50	16	m ² sqm	0,66	42,624	6	4	32,6	20,83	1348

* Unidad de Medida. Los artículos medidos en m² o ml se sirven contando la junta normal entre piezas.
* Unit of Measure. Items measured in sqm or lm are delivered assuming average joint between pieces.



Capri Carbón 33x50
Capri Hueso 6x33



Capri Gris 33x33

CAPRI

ESMALTADOS
GLAZED TILES

Colores / Colors

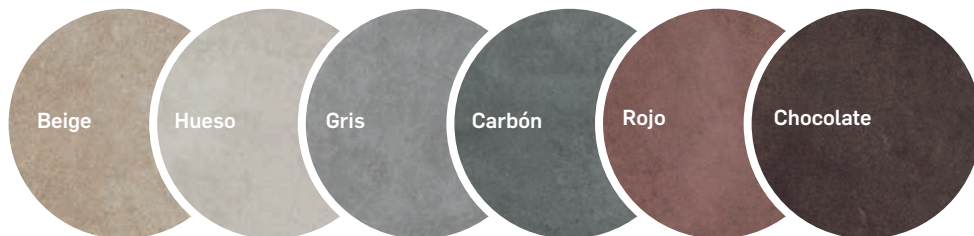

Capri Hueso 33x33

	Espe- sor (mm) Thick- ness (mm)	U.M.*	U.M./Caja U.M./Box	U.M./Palet U.M./Pallet	Pzs./U.M. Pcs./U.M.	Pzs./Caja Pcs./Box	Kg./U.M. Kg./U.M.	Kg./Caja Kg./Box	Kg./Palet Kg./Pallet
Peldaño redondeado 33 Rounded stair-tread 33	18	Pz. Pc.	6	216	1	6	4,4	26,4	950
Peldaño redondeado 50 Rounded stair-tread 50	18	Pz. Pc.	4	144	1	4	6,94	27,7	1000
Peldaño recto 50 Straight stair-tread 50	18	Pz. Pc.	4	144	1	4	6,33	25,3	911
Esquina redondeada Rounded stair-tread corner	18	Pz. Pc.	2	60	1	2	6	12	360
Rodapié Skirting board	16	ml lm	8	576	3	24	2,3	18,4	1325
Zanquín izda. String left	16	Pz. Pc.	10	300	1	10	1,3	13	390
Zanquín dcha. String right	16	Pz. Pc.	10	300	1	10	1,3	13	390
Tabica 12x33 Riser 12x33	16	Pz. Pc.	16	640	1	16	1,12	17,92	716,80

* Unidad de Medida. Los artículos medidos en m² o ml se sirven contando la junta normal entre piezas.
* Unit of Measure. Items measured in sqm or lm are delivered assuming average joint between pieces.

Anchura recomendada de la junta de colocación: 6 - 8 mm
Recommended joint width 6 - 8 mm

Piezas especiales Special pieces

PELDAÑO REDONDEADO 33

ROUNDED STAIR-TREAD 33
[325x330x18 mm]

Beige	Cod. 905084	[PZ270]
Hueso	Cod. 905085	[PZ270]
Gris	Cod. 905086	[PZ270]
Carbón	Cod. 905087	[PZ270]
Rojo	Cod. 905652	[PZ270]
Chocolate	Cod. 905145	[PZ270]

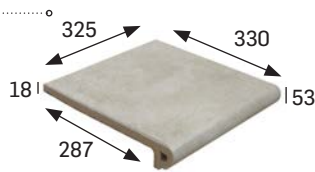

PELDAÑO REDONDEADO 50

ROUNDED STAIR-TREAD 50
[492x330x18 mm]

Beige	Cod. 905088	[PZ355]
Hueso	Cod. 905089	[PZ355]
Gris	Cod. 905090	[PZ355]
Carbón	Cod. 905091	[PZ355]
Rojo	Cod. 905653	[PZ355]
Chocolate	Cod. 905146	[PZ355]



PELDAÑO RECTO 50

STRAIGHT STAIR-TREAD 50
[492x330x18 mm]

Beige	Cod. 905092	[PZ355]
Hueso	Cod. 905093	[PZ355]
Gris	Cod. 905094	[PZ355]
Carbón	Cod. 905095	[PZ355]
Rojo	Cod. 905654	[PZ355]
Chocolate	Cod. 905147	[PZ355]



ESQUINA REDONDEADA

ROUNDED STAIR-TREAD CORNER
[330x330x18 mm]

Beige	Cod. 905096	[PZ555]
Hueso	Cod. 905097	[PZ555]
Gris	Cod. 905098	[PZ555]
Carbón	Cod. 905099	[PZ555]
Rojo	Cod. 905655	[PZ555]
Chocolate	Cod. 905148	[PZ555]

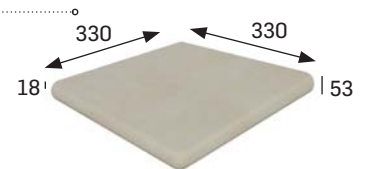

ZANQUÍN IZDA.

STRING LEFT SIDE
[390x80/200x100x16 mm]

Beige	Cod. 905104	[PZ160]
Hueso	Cod. 905105	[PZ160]
Gris	Cod. 905106	[PZ160]
Carbón	Cod. 905107	[PZ160]
Rojo	Cod. 905657	[PZ160]
Chocolate	Cod. 905150	[PZ160]

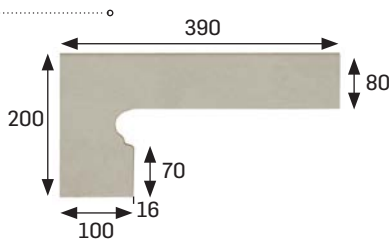

ZANQUÍN DCHA.

STRING RIGHT SIDE
[390x80/200x100x16 mm]

Beige	Cod. 905100	[PZ160]
Hueso	Cod. 905101	[PZ160]
Gris	Cod. 905102	[PZ160]
Carbón	Cod. 905103	[PZ160]
Rojo	Cod. 905656	[PZ160]
Chocolate	Cod. 905149	[PZ160]

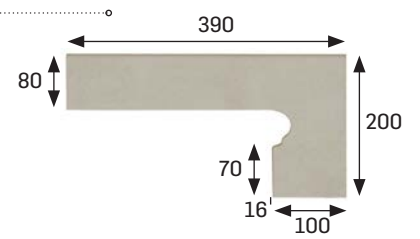

Decorados Decors

TABICA 12X33

RISER 12x33
[325x119x16 mm]

Capri Beige 1 12x33	Cod. 905317	[PZ050]
Capri Beige 2 12x33	Cod. 905318	[PZ050]

Capri Beige 1



Capri Beige 2

Capri Hueso 1 12x33	Cod. 905319	[PZ050]
Capri Hueso 2 12x33	Cod. 905320	[PZ050]

Capri Hueso 1



Capri Hueso 2

Capri Gris 1 12x33	Cod. 905323	[PZ050]
Capri Gris 2 12x33	Cod. 905324	[PZ050]

Capri Gris 1



Capri Gris 2

Capri Carbón 1 12x33	Cod. 905321	[PZ050]
Capri Carbón 2 12x33	Cod. 905322	[PZ050]

Capri Carbón 1



Capri Carbón 2

Capri Chocolate 1 12x33	Cod. 905315	[PZ050]
Capri Chocolate 2 12x33	Cod. 905316	[PZ050]

Capri Chocolate 1



Capri Chocolate 2

TIRAS STRIPS

ESMALTADOS GLAZED TILES
NATURALES NATURAL TILES

BASE 6x25 TILE 6x25*

[62x244x10 mm]

Natural	Cod. 902878	[MC415]
Cotto Rojo	Cod. 903840	[MC427]
Cotto Blanco	Cod. 903841	[MC427]
Cotto Gris	Cod. 903842	[MC427]
Albany Teka	Cod. 902191	[MC480]
Isla Malta	Cod. 902948	[MC480]
Parma	Cod. 903832	[MC480]
Pisa	Cod. 903553	[MC480]
Añil Blanco	Cod. 902874	[MC427]
Añil Gris	Cod. 902875	[MC427]
Añil Tierra	Cod. 902876	[MC427]
Añil Rosa	Cod. 902873	[MC427]

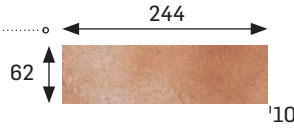

* Se obtiene a partir de base de 12x25 premarcada.

* It is obtained from 12x25 premarked tile.

Colores / Colors



ÁNGULO FACHADA

FACADE ANGLE

[244x119x58 x12 mm]

Albany Teka	Cod. 901464	[PZ070]
Isla Malta	Cod. 901467	[PZ070]
Parma	Cod. 901396	[PZ070]
Pisa	Cod. 904547	[PZ070]
Añil Blanco	Cod. 902968	[PZ070]
Añil Gris	Cod. 902969	[PZ070]
Añil Tierra	Cod. 902970	[PZ070]
Añil Rosa	Cod. 902971	[PZ070]

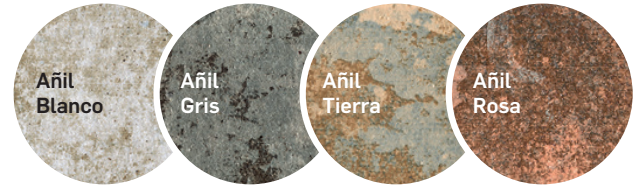
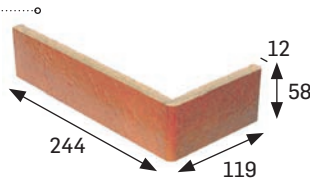

	Espesor (mm) Thickness (mm)	U.M.*	U.M./Caja U.M./Box	U.M./Palet U.M./Pallet	Pzs./U.M. Pcs./U.M.	Pzs./Caja Pcs./Box	Kg./U.M. Kg./U.M.	Kg./Caja Kg./Box	Kg./Palet Kg./Pallet
Base 6x25 (12x25 premarcada) Tile 6x25 (premarked tile 12x25)	10	m ² sqm	0,64	76,8	64	40	17	10,640	1276,8
Ángulo fachada Facade angle	12	Pz. Pc.	16	896	1	16	0,48	7,75	434

* Unidad de Medida. Los artículos medidos en m² o ml se sirven contando la junta normal entre piezas.
* Unit of Measure. Items measured in sqm or lm are delivered assuming average joint between pieces.



Mix Añil 6x25

TIRAS STRIPS

ESMALTADOS GLAZED TILES
NATURALES NATURAL TILES

BASE 6x33 TILE 6x33*

[62x325x10 mm]

Natural	Cod. 903942	[MC427]
Mytho Acero	Cod. 902333	[MC503]
Mytho Rubino	Cod. 903034	[MC503]
Orión Beige	Cod. 904478	[MC560]
Orión Gris	Cod. 904474	[MC560]
Orión Jade	Cod. 904477	[MC560]
Orión Antracita	Cod. 904605	[MC560]
Capri Beige	Cod. 905068	[MC560]
Capri Hueso	Cod. 905069	[MC560]
Capri Gris	Cod. 905070	[MC560]
Capri Carbón	Cod. 905071	[MC560]
Capri Rojo	Cod. 905648	[MC560]
Capri Chocolate	Cod. 905141	[MC560]

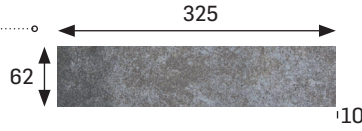

Colores / Colors

* Se obtiene a partir de base de 12x33 premarcada.

* It is obtained from 12x33 premarked tile.

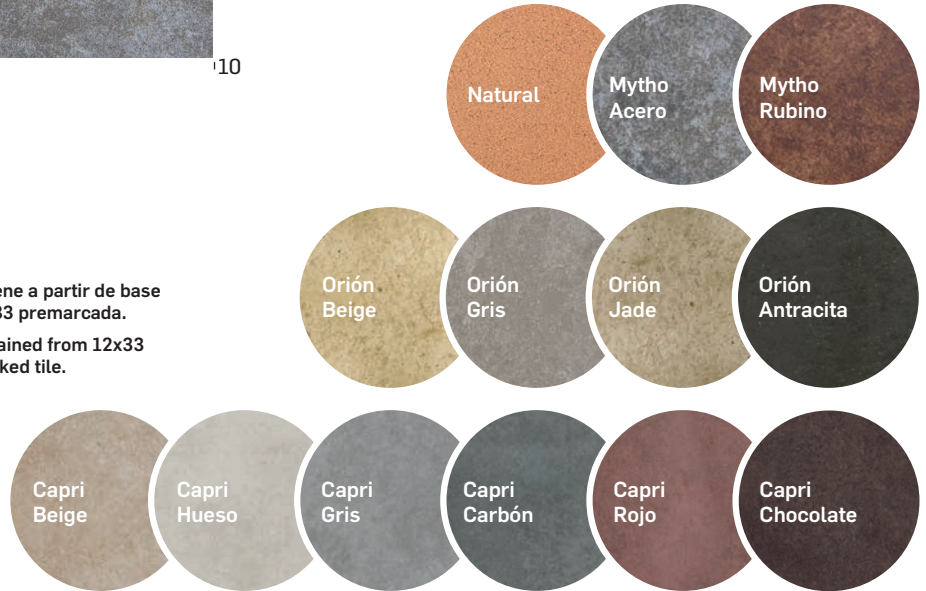

BASE 6x50 TILE 6x50*

[62x482x10 mm]

Orión Beige	Cod. 905779	[MC570]
Orión Gris	Cod. 905780	[MC570]
Orión Jade	Cod. 905781	[MC570]
Orión Antracita	Cod. 905782	[MC570]
Capri Beige	Cod. 905123	[MC570]
Capri Hueso	Cod. 905124	[MC570]
Capri Gris	Cod. 905125	[MC570]
Capri Carbón	Cod. 905126	[MC570]
Capri Rojo	Cod. 905784	[MC570]
Capri Chocolate	Cod. 905783	[MC570]



Colores / Colors

* Se obtiene a partir de base de 12x50 premarcada.

* It is obtained from 12x50 premarked tile.

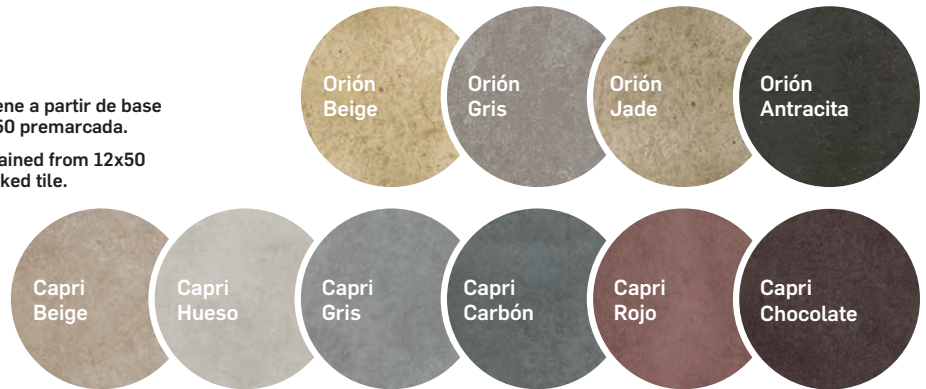

	Espesor (mm) Thickness (mm)	U.M.*	U.M./Caja U.M./Box	U.M./Palet U.M./Pallet	Pzs./U.M. Pcs./U.M.	Pzs./Caja Pcs./Box	Kg./U.M. Kg./U.M.	Kg./Caja Kg./Box	Kg./Palet Kg./Pallet
Base 6x33 (12x33 premarcada) Tile 6x33 (premarked tile 12x33)	10	m ² sqm	0,88	79,2	45,45	40	17,7	15,6	1404
Base 6x50 (12x50 premarcada) Tile 6x50 (premarked tile 12x50)	10	m ² sqm	0,99	69,3	30,3	30	17,6	17,4	1218

* Unidad de Medida. Los artículos medidos en m² o ml se sirven contando la junta normal entre piezas.
* Unit of Measure. Items measured in sqm or lm are delivered assuming average joint between pieces.



Mix Orión 6x50

NATURAL

NATURALES NATURAL TILES

Colores / Colors

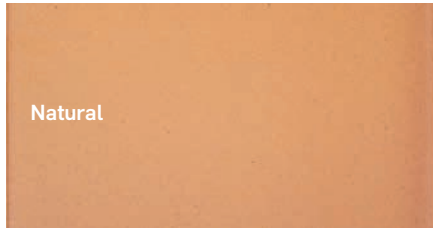

(cm) Formatos / Sizes

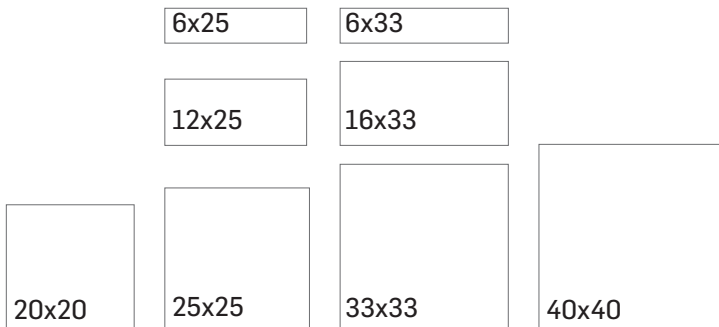

	NATURAL UNGLAZED	
	Características dimensionales Dimension tolerance	<1,25% máx 2 mm
	Absorción de agua Water absorption	3<E≤6%
	Coef. Dilatación termica lineal Linear thermal expansion coefficient	3,8x10 ⁻⁶ xC ⁻¹
	Resistencia a la flexión Breaking Strength	20 a 25 N/mm ²
	Resistencia a la abrasión profunda Resistance to deep abrasion	<393 mm ³
	Resistencia al rayado (Método Mohs) Scratch hardness of surface (Mohs Method)	6
	Resistencia a las manchas Resistance to stains	clase 3 a 5 class 3 to 5
	Péndulo (CTE) Not required out of Spain	clase 3 class 3
	A pie descalzo Barefoot slip resistance	C
	A pie calzado Slip resistance with footwear	R11
	Extrusión Extruded tiles	✓
	Resistencia a la helada Frost resistance	✓
	Resistencia al choque térmico Resistance to thermal shock	✓
	Resistencia química Chemical resistance	✓
	Resistencia al choque térmico Resistance to thermal shock	✓
	Resistencia química Chemical resistance	✓



Natural 33x33

NATURAL

NATURALES
NATURAL TILES

Colores / Colors

Natural

BASE 6x25* TILE 6x25*

[62x244x10 mm]

Natural Cod. 902878 [MC415]

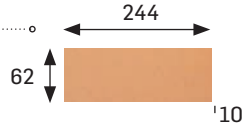

*Se obtiene a partir de base de 12x25 premarcada.
*It is obtained from 12x25 premarked tile.

BASE 6x33* TILE 6x33*

[62x325x10 mm]

Natural Cod. 903942 [MC427]

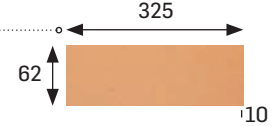

*Se obtiene a partir de base de 12x33 premarcada.
*It is obtained from 12x33 premarked tile.

BASE 12x25 TILE 12x25

[119x244x14 mm]

Natural Cod. 900013 [MC415]

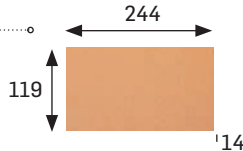

BASE 16x33 TILE 16x33

[159x325x16 mm]

Natural Cod. 901068 [MC460]

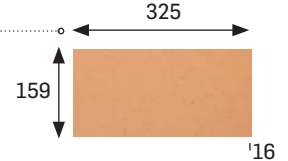

BASE 25x25 TILE 25x25

[244x244x14 mm]

Natural Cod. 900005 [MC390]

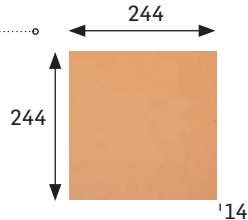

BASE 33x33 TILE 33x33

[325x325x16 mm]

Natural Cod. 901001 [MC440]

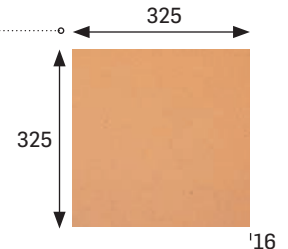

BASE 20x20 TILE 20x20

[195x195x14 mm]

Natural Cod. 900181 [MC400]

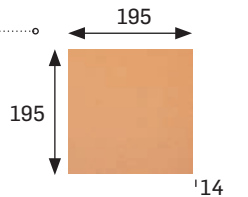

BASE 40x40 TILE 40x40

[395x395x20 mm]

Natural Cod. 901200 [MC570]

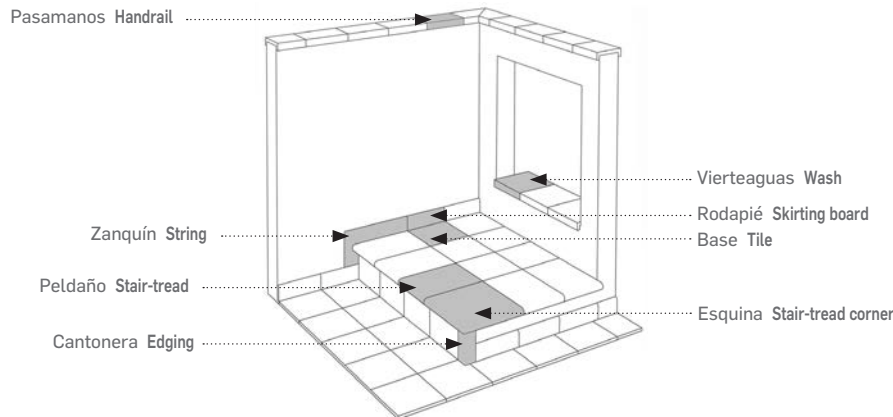
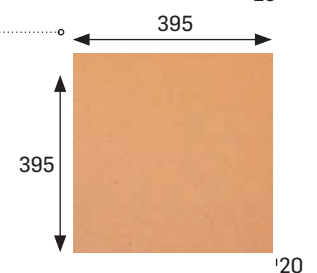

	Espesor (mm) Thickness (mm)	U.M.*	U.M./Caja U.M./Box	U.M./Palet U.M./Pallet	Pzs./U.M. Pcs./U.M.	Pzs./Caja Pcs./Box	Kg./U.M. Kg./U.M.	Kg./Caja Kg./Box	Kg./Palet Kg./Pallet
Base 6x25 (12x25 premarcada) Tile 6x25 (premarked tile 12x25)	10	m ² sqm	0,64	76,8	64	40	17	10,640	1276,8
Base 6x33 (12x33 premarcada) Tile 6x33 (premarked tile 12x33)	10	m ² sqm	0,88	79,2	45,45	40	17,7	15,6	1404
Base 12x25 Tile 12x25	14	m ² sqm	0,5	60	32	16	24,80	12,40	1489
Base 16x33 Tile 16x33	16	m ² sqm	0,68	40	18	12	30,6	20,4	1225
Base 25x25 Tile 25x25	14	m ² sqm	1	60	16	16	26	26	1560
Base 33x33 Tile 33x33	16	m ² sqm	0,666	42,624	9	6	32,6	21,75	1391
Base 20x20 Tile 20x20	14	m ² sqm	0,84	50,4	25	21	24,2	20,32	1219
Base 40x40 Tile 40x40	20	m ² sqm	0,64	19,2	6,25	4	40,1	25,6	769,8

* Unidad de Medida. Los artículos medidos en m² o ml se sirven contando la junta normal entre piezas.

* Unit of Measure. Items measured in sqm or lm are delivered assuming average joint between pieces.

NATURAL

TABICA 12X33

RISER 12X33
[325x119x16 mm]

Natural 1 12x33 Cod. 905313 [PZ220]
Natural 2 12x33 Cod. 905314 [PZ220]



Natural 1



Natural 2

DENIA

TABICA 14X25

RISER 14X25
[244x140x14 mm]

Denia 14x25 Cod. 901086 [PZ220]



Denia 25

TABICA 14X33

RISER 14X33
[325x140x16 mm]

Denia 14x33 Cod. 901087 [PZ220]



Denia 33

ALHAMBRA

TABICA 14X25

RISER 14X25
[244x140x14 mm]

Alhambra 14x25 Cod. 901089 [PZ220]



Alhambra 25

TABICA 14X33

RISER 14X33
[325x140x16 mm]

Alhambra 14x33 Cod. 901090 [PZ220]



Alhambra 33

CATEDRAL

TABICA 12X25

RISER 12X25
[244x119x14 mm]

Azul 12x25 Blue 12x25 Cod. 900470 [PZ140]



Catedral Azul 12x25

TABICA 14X25

RISER 14X25
[244x140x14 mm]

Azul 14x25 Blue 14x25 Cod. 900469 [PZ220]



Catedral Azul 14x25

TABICA 14X33

RISER 14X33
[325x140x16 mm]

Azul 14x33 Blue 14x33 Cod. 900567 [PZ220]



Catedral Azul 14x33

	Espe- sor (mm) Thick- ness (mm)	U.M.*	U.M./Caja U.M./Box	U.M./Palet U.M./Pa- llet	Pzs./U.M. Pcs./U.M.	Pzs./Caja Pcs./Box	Kg./U.M. Kg./U.M.	Kg./Caja Kg./Box	Kg./Palet Kg./Pallet
Tabica 12x33 Riser 12x33	16	Pz. Pc.	16	640	1	16	1,12	17,92	716,80
Tabica Denia 14x25 Riser 14x25	14	Pz. Pc.	19	-	1	19	0,84	16	-
Tabica Denia 14x33 Riser 14x33	16	Pz. Pc.	12**	-	1	12**	1,6	18,9	-
Tabica Alhambra 14x25 Riser 14x25	14	Pz. Pc.	19	-	1	19	0,84	16	-
Tabica Alhambra 14x33 Riser 14x33	16	Pz. Pc.	12**	-	1	12**	1,6	18,9	-
Tabica Catedral 12x25 Riser 12x25	14	Pz. Pc.	17	-	1	17	0,8	13,3	-
Tabica Catedral 14x25 Riser 14x25	14	Pz. Pc.	20	-	1	20	0,9	17,4	-
Tabica Catedral 14x33 Riser 14x33	16	Pz. Pc.	13/12**	-	1	13/12**	1,6	20,8	-

NATURAL

NATURALES
NATURAL TILES

Colores / Colors

Natural



Natural 20x20

	Espe- sor (mm) Thickness (mm)	U.M.*	U.M./Caja U.M./Box	U.M./Palet U.M./Pallet	Pzs./U.M. Pcs./U.M.	Pzs./Caja Pcs./Box	Kg./U.M. Kg./U.M.	Kg./Caja Kg./Box	Kg./Palet Kg./Pallet
Peldaño recto 25 Straight stair-tread 25	20	Pz. Pc.	6	324	1	6	3,4	20,3	1095
Peldaño recto 33 Straight stair-tread 33	20	Pz. Pc.	6	216	1	6	4,8	28,8	1037
Peldaño redondeado 25 Rounded stair-tread 25	18	Pz. Pc.	6	324	1	6	3,3	19,8	1069
Peldaño redondeado 33 Rounded stair-tread 33	18	Pz. Pc.	6	216	1	6	4,4	26,4	950
Esquina redondeada Rounded stair-tread corner	18	Pz. Pc.	2	60	1	2	6	12	360
Esquina recta Straight stair-tread corner	20	Pz. Pc.	2	60	1	2	6,2	12,4	372
Rodapié 25 Skirting board 25	14	ml lm	11,25	450	4	45	2,3	25,9	1038,6
Rodapié 33 Skirting board 33	16	ml lm	8	576	3	24	2,3	18	1296
Zanquín recto izda. Straight string left side	16	Pz. Pc.	10	300	1	10	1,3	13	390
Zanquín recto dcha. Straight string right side	16	Pz. Pc.	10	300	1	10	1,3	13	390
Zanquín redondeado izda. Rounded string left side	16	Pz. Pc.	10	300	1	10	1,3	13	390
Zanquín redondeado dcha. Rounded string right side	16	Pz. Pc.	10	300	1	10	1,3	13	390

* Unidad de Medida. Los artículos medidos en m² o ml se sirven contando la junta normal entre piezas.
* Unit of Measure. Items measured in sqm or lm are delivered assuming average joint between pieces.

Anchura recomendada de la junta de colocación: 6 - 8 mm
Recommended joint width 6 - 8 mm

Piezas especiales Special pieces

PELDAÑO RECTO 25

STRAIGHT STAIR-TREAD 25
[325x330x18 mm]

Natural Cod. 901315 [PZ180]

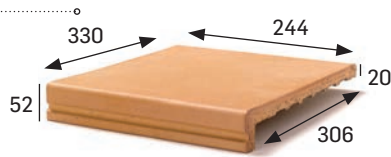

PELDAÑO RECTO 33

STRAIGHT STAIR-TREAD 33
[244x330x18 mm]

Natural Cod. 901316 [PZ240]

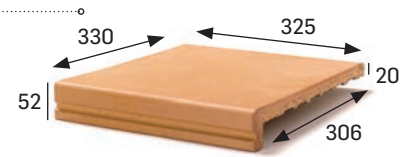

PELDAÑO REDONDEADO 25

ROUNDED STAIR-TREAD 25
[330x330x18 mm]

Natural Cod. 900024 [PZ180]

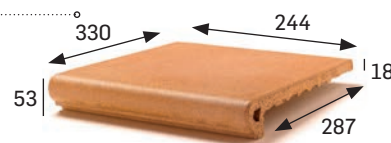

PELDAÑO REDONDEADO 33

ROUNDED STAIR-TREAD 33
[244x330x18 mm]

Natural Cod. 901051 [PZ240]

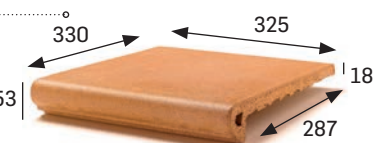

ESQUINA REDONDEADA

ROUNDED STAIR-TREAD CORNER
[325x80x16 mm]

Natural Cod. 900040 [PZ465]

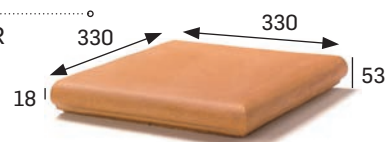

ESQUINA RECTA

STRAIGHT STAIR-TREAD CORNER
[244x80x14 mm]

Natural Cod. 901317 [PZ465]



RODAPIÉ 25

SKIRTING BOARD 25
[390x80/200x100x16 mm]

Natural Cod. 900030 [ML100]

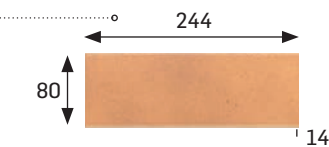

RODAPIÉ 33

SKIRTING BOARD 33
[390x80/200x100x16 mm]

Natural Cod. 901021 [ML145]



ZANQUÍN RECTO IZDA.

STRAIGHT STRING LEFT SIDE
[244x191x40x18 mm]

Natural Cod. 901318 [PZ100]

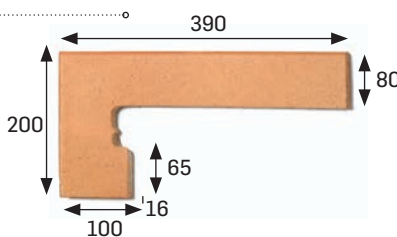

ZANQUÍN RECTO DCHA.

STRAIGHT STRING RIGHT SIDE
[244x119x58x12 mm]

Natural Cod. 901319 [PZ100]

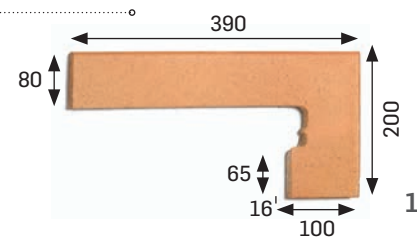

ZANQUÍN REDONDEADO IZDA.

ROUNDED STRING LEFT SIDE
[390x80/200x100x16 mm]

Natural Cod. 900034 [PZ100]

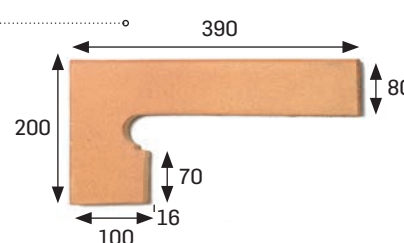

ZANQUÍN REDONDEADO DCHA.

ROUNDED STRING RIGHT SIDE
[390x80/200x100x16 mm]

Natural Cod. 900456 [PZ100]

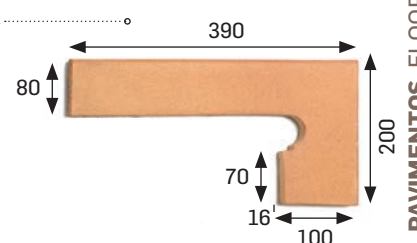

NATURAL

NATURALES
NATURAL TILES

Colores / Colors

Natural



Natural 33x33

	Espesor (mm) Thickness (mm)	U.M.*	U.M./Caja U.M./Box	U.M./Palet U.M./Pallet	Pzs./U.M. Pcs./U.M.	Pzs./Caja Pcs./Box	Kg./U.M. Kg./U.M.	Kg./Caja Kg./Box	Kg./Palet Kg./Pallet
Tabica 25 Riser 25	20	Pz. Pc.	7	280	4	7	4	28	1120
Tabica 33 Riser 33	20	Pz. Pc.	4,33	320,66	3	13	3,8	16,5	1217
Borde desbordante Overflowing edge	26-22	Pz. Pc.	4	128	1	4	5	20	640
Esq. int. borde desbordante Overflowing internal edge	26	Jg. Set	2	-	2	4	8	16	-
Esq. ext. borde desbordante Overflowing external edge	26	Jg. Set	2	-	2	4	5,4	10,8	-
Rejilla cerámica monocompact Monocompact ceramic grid	25	Pz. Pc.	6	378	1	6	3,58	21,5	-
Esquina rejilla Corner grid	25	Set Set	3	-	2	6	4,69	14,07	-
Canaleta Overflow channel	30	Pz. Pc.	3	99	1	3	4,43	13,3	438,6
Vierteaguas 33x33 Wash 33x33	18	Pz. Pc.	6	216	1	6	4,3	25,8	928,8
Vierteaguas 25x25 Wash 25x25	16	Pz. Pc.	8	480	1	8	2,1	17	1027
Vierteaguas 25x33 Wash 25x33	18	Pz. Pc.	6	324	1	6	3,13	18,78	1014

* Unidad de Medida. Los artículos medidos en m² o ml se sirven contando la junta normal entre piezas.
* Unit of Measure. Items measured in sqm or lm are delivered assuming average joint between pieces.

Anchura recomendada de la junta de colocación: 6 - 8 mm
Recommended joint width 6 - 8 mm

Piezas especiales Special pieces

TABICA 25

RISER 25
[244x120x20 mm]

Natural Cod. 900032 [PZ025]

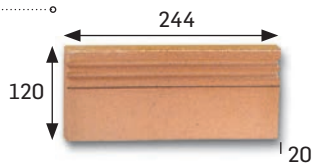

TABICA 33

RISER 33
[325x120x20 mm]

Natural Cod. 900068 [PZ045]



BORDE DESBORDANTE

OVERFLOWING EDGE
[330x325x22 x26mm]

Natural Cod. 902795 [PZ225]

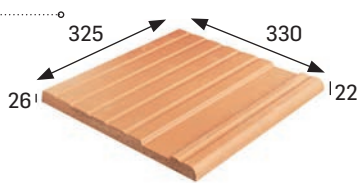

ESQ. INT. BORDE DESBORDANTE

OVERFLOWING INTERNAL EDGE
[330x444x119x26 mm]

Natural Cod. 901931 [JG395]

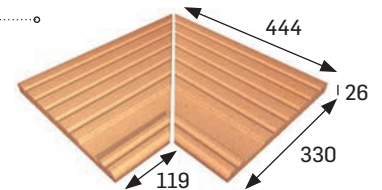

ESQ. EXT. BORDE DESBORDANTE

OVERFLOWING EXTERNAL EDGE
[330x353x26x22 mm]

Natural Cod. 901932 [JG395]

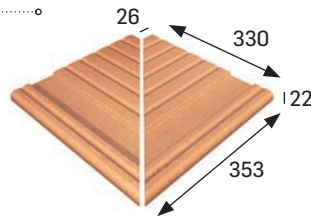

REJILLA CERÁMICA MONOCOMPACT

MONOCOMPACT CERAMIC GRID **
[325x244x25 mm]

Natural Cod. 902972 [PZ645]

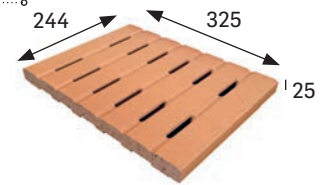

** En rejillas los agujeros siempre deben ir perpendiculares al vaso para una mayor resistencia, con canal de 250 mm de ancho.

** Install the grids with the holes always perpendicular to the pool vessel to get a greater resistance, with a channel 250 mm wide.

ESQUINA REJILLA

CORNER GRID
[293x244x25x80 mm]

Natural Cod. 901489 [JG750]

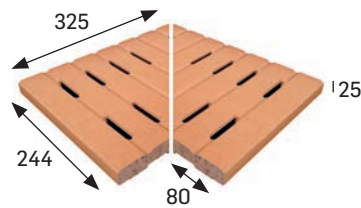

CANALETA

OVERFLOW CHANNEL*
[325x325x30 mm]

Natural Cod. 901871 [PZ250]

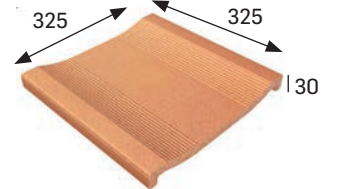

* Disponible Canaleta con desagüe.

* Overflow channel with drainage available.

VIERTEAGUAS 33X33

NATURAL WASH 33X33
[325x330x40x21 mm]

Natural Cod. 900191 [PZ225]



VIERTEAGUAS 25X25

NATURAL WASH 25X25
[244x244x40x16 mm]

Natural Cod. 900036 [PZ150]

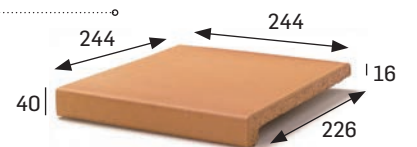

VIERTEAGUAS 25X33

NATURAL WASH 25X33
[330x244x40x21 mm]

Natural Cod. 900188 [PZ165]

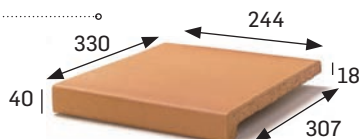

NATURAL

NATURALES
NATURAL TILES

Colores / Colors

Natural

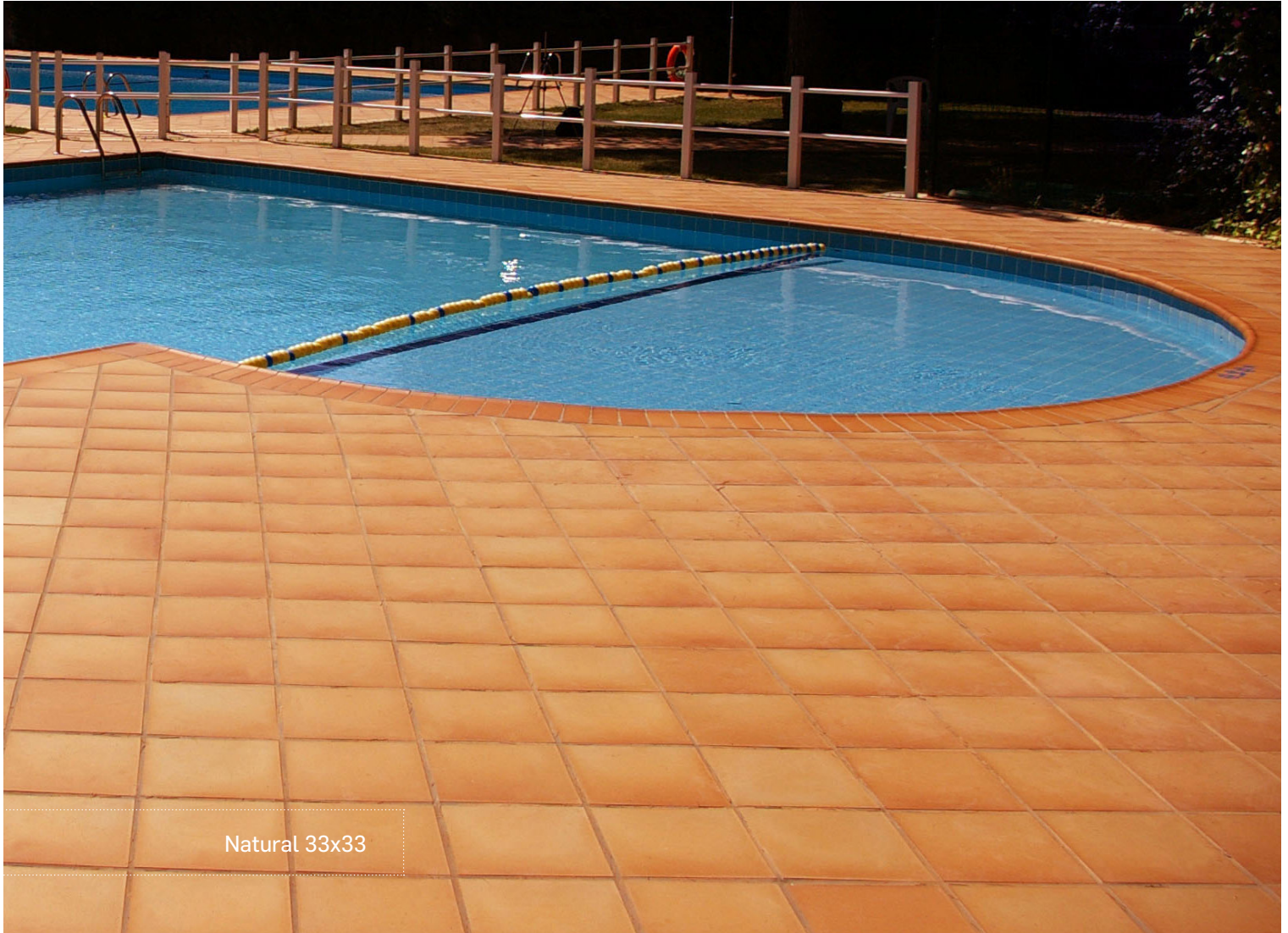

Natural 33x33

	Espesor (mm) Thickness (mm)	U.M.*	U.M./Caja U.M./Box	U.M./Palet U.M./Pallet	Pzs./U.M. Pcs./U.M.	Pzs./Caja Pcs./Box	Kg./U.M. Kg./U.M.	Kg./Caja Kg./Box	Kg./Palet Kg./Pallet
Ángulo desigual Unequal edge	14	Pz. Pc.	16	896	1	16	1,19	14,6	876
Pasamanos 27,5 Handrail 27,5	18	Pz. Pc.	4	144	1	4	4,6	18,4	662
Pasamanos 21,5 Handrail 21,5	18	Pz. Pc.	5	300	1	5	2,6	13	780
Pasamanos 15,5 Handrail 15,5	18	Pz. Pc.	8	320	1	8	2,2	17,6	704
Pasamanos 12,5 Handrail 12,5	18	Pz. Pc.	11	396	1	11	1,8	19,8	712,8
Remate esq. int. Internal corner	24	Pz. Pc.	2	60	1	2	7,4	14,8	444
Remate esq. ext. External corner	24	Pz. Pc.	2	56	1	2	6,3	12,6	354
Remate 33 Edge 33	25	Pz. Pc.	4	168	1	4	5	19,8	832
Remate 10 Edge 10	25	Pz. Pc.	12	504	1	12	1,85	22,2	932,4
Cantonera ref. 31 Edging ref. 31	14	Pz. Pc.	30	1800	1	30	0,7	20,2	1215
Escocia Key corner piece	16	Pz. Pc.	6	-	1	6	0,3	2,3	-
Ángulo ref. 41R Angle Ref. 41R	14	Pz. Pc.	24	1440	1	24	0,8	19,2	1152

* Unidad de Medida. Los artículos medidos en m² o ml se sirven contando la junta normal entre piezas.
* Unit of Measure. Items measured in sqm or lm are delivered assuming average joint between pieces.

Anchura recomendada de la junta de colocación: 6 - 8 mm
Recommended joint width 6 - 8 mm

Piezas especiales Special pieces

ÁNGULO DESIGUAL

UNEQUAL EDGE

[244x128x60x14 mm]

Natural Cod. 900037 [PZ100]

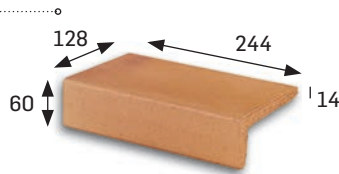

PASAMANOS INT. 27,5

HANDRAIL INT. 27,5

[325x311x60x18 mm]

Natural Cod. 900073 [PZ285]

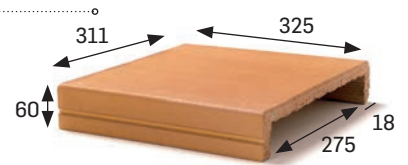

PASAMANOS INT. 21,5

HANDRAIL INT. 21,5

[251x244x46x18 mm]

Natural Cod. 900007 [PZ180]

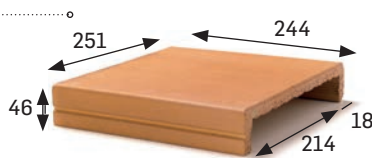

PASAMANOS INT. 15,5

HANDRAIL INT. 15,5

[244x191x40x18 mm]

Natural Cod. 900016 [PZ165]

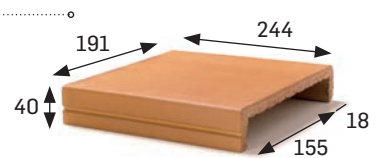

PASAMANOS INT. 12,5

HANDRAIL INT. 12,5

[330x353x26x22 mm]

Natural Cod. 900017 [PZ145]

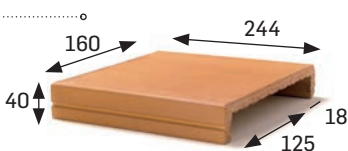

REMATE ESQUINA INTERIOR

INTERNAL CORNER

[325x325x65x24 mm]

Natural Cod. 900184 [PZ525]

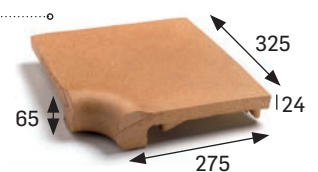

REMATE ESQUINA EXTERIOR

EXTERNAL CORNER

[275x275x65x24 mm]

Natural Cod. 900204 [PZ525]

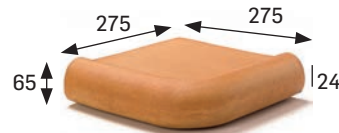

REMATE 33

EDGE 33

[325x275x65x25 mm]

Natural Cod. 900197 [PZ290]

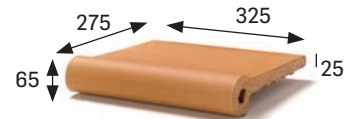

REMATE 10

EDGE 10

[275x103x65x25 mm]

Natural Cod. 900194 [PZ260]

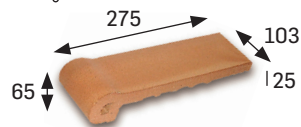

CANTONERA REF. 31

EDGING REF.31

[244x60x60x14 mm]

Natural Cod. 900028 [PZ090]

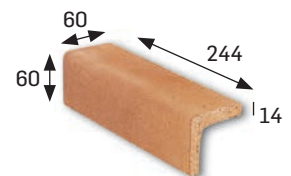

ESCOCIA

KEY PIECE

[60x60x60x16 mm]

Natural Cod. 900026 [PZ180]

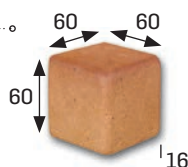

ÁNGULO REF. 41R

EDGING REF. 41R

[244x60x60x14 mm]

Natural Cod. 900035 [PZ100]

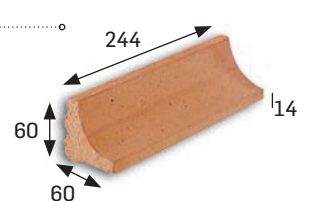

NATURALES NATURAL TILES

CLASSIC



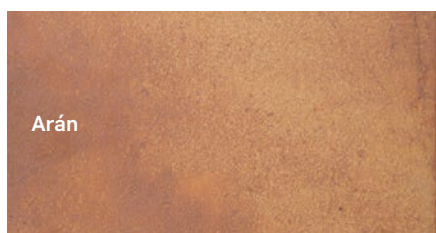





Colores / Colors



Los colores son indicativos.
Colors are just indicative.

(cm) Formatos / Sizes



 NATURAL UNGLAZED	
 Características dimensionales Dimension tolerance	<1,25% máx 2 mm
 Absorción de agua Water absorption	3<E≤6%
 Coef. Dilatación termica lineal Linear thermal expansion coefficient	3,8x10 ⁻⁶ xC ⁻¹
 Resistencia a la flexión Breaking Strength	20 N/mm ²
 Resistencia a la abrasión profunda Resistance to deep abrasion	<393 mm ³
 Resistencia al rayado (Método Mohs) Scratch hardness of surface (Mohs Method)	6
 Resistencia a las manchas Resistance to stains	clase 3 a 5 class 3 to 5
 Péndulo (CTE) Not required out of Spain	clase 3 class 3
 A pie descalzo Barefoot slip resistance	C
 A pie calzado Slip resistance with footwear	R11
 Extrusión Extruded tiles	✓
 Resistencia a la helada Frost resistance	✓
 Resistencia al choque térmico Resistance to thermal shock	✓
 Resistencia química Chemical resistance	✓



Arán 33x33

NATURALES NATURAL TILES

CLASSIC

Colores / Colors

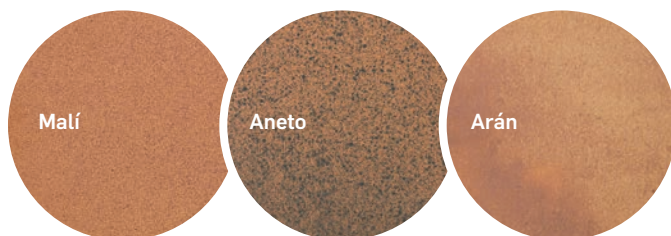

BASE 33x33 TILE 33x33

[325x325x16 mm]

Malí Cod. 901251 [MC485]
Aneto Cod. 901987 [MC485]
Arán Cod. 903059 [MC485]

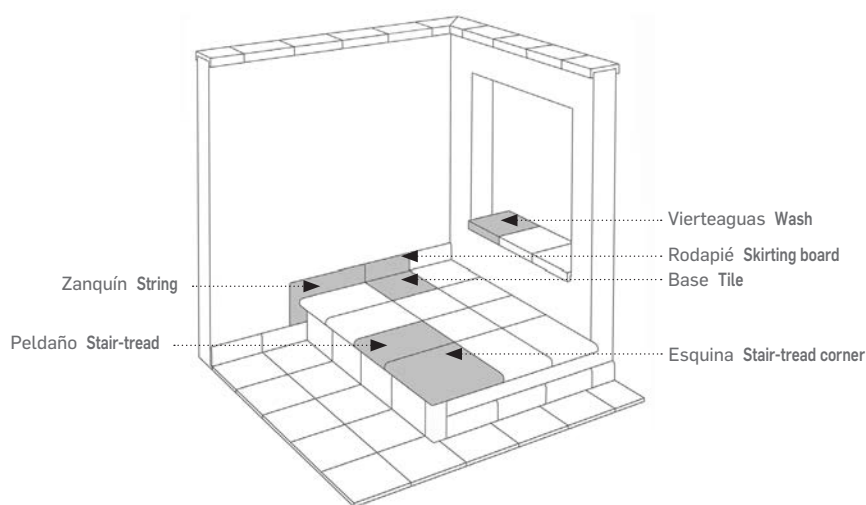
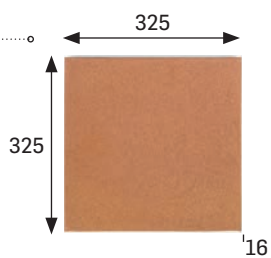

138

PAVIMENTOS FLOOR TILES

	Espeor (mm) Thickness (mm)	U.M.*	U.M./Caja U.M./Box	U.M./Palet U.M./Pallet	Pzs./U.M. Pcs./U.M.	Pzs./Caja Pcs./Box	Kg./U.M. Kg./U.M.	Kg./Caja Kg./Box	Kg./Palet Kg./Pallet
Base 33x33 Tile 33x33	16	m ² sqm	0,666	42,624	9	6	32,6	21,75	1391

* Unidad de Medida. Los artículos medidos en m² o ml se sirven contando la junta normal entre piezas.
 * Unit of Measure. Items measured in sqm or lm are delivered assuming average joint between pieces.



Mali 33x33

NATURALES NATURAL TILES

CLASSIC

Colores / Colors

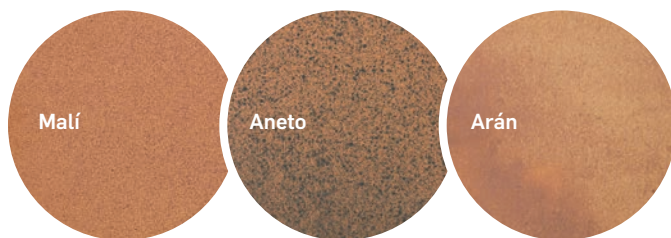

Aneto 33x33

	Espeor (mm) Thickness (mm)	U.M.*	U.M./Caja U.M./Box	U.M./Palet U.M./Pallet	Pzs./U.M. Pcs./U.M.	Pzs./Caja Pcs./Box	Kg./U.M. Kg./U.M.	Kg./Caja Kg./Box	Kg./Palet Kg./Pallet
Peldaño redondeado 33 Rounded stair-tread 33	18	Pz. Pc.	6	216	1	6	4,4	26,4	950
Esquina redondeada Rounded stair-tread corner	18	Pz. Pc.	2	60	1	2	6	12	360
Remate Edge	25	Pz. Pc.	4	168	1	4	5	19,8	832
Remate esq. ext. External corner	24	Pz. Pc.	2	56	1	2	6,3	12,6	354
Remate esq. int. Internal corner	24	Pz. Pc.	2	60	1	2	7,4	14,8	444
Zanquín izda. String left	16	Pz. Pc.	10	300	1	10	1,3	13	390
Zanquín dcha. String right	16	Pz. Pc.	10	300	1	10	1,3	13	390
Rodapié Skirting board	16	ml lm	8	576	3	24	2,3	18	1296
Vierteaguas 33x33 Wash 33x33	18	Pz. Pc.	6	216	1	6	4,3	25,8	928,8

* Unidad de Medida. Los artículos medidos en m² o ml se sirven contando la junta normal entre piezas.
* Unit of Measure. Items measured in sqm or lm are delivered assuming average joint between pieces.

Anchura recomendada de la junta de colocación: 6 - 8 mm
Recommended joint width 6 - 8 mm

Piezas especiales Special pieces

PELDAÑO REDONDEADO 33

ROUNDED STAIR-TREAD 33
[325x330x53x18 mm]

Malí Cod. 901252 [PZ270] 53
Aneto Cod. 901988 [PZ270]
Arán Cod. 903060 [PZ270]

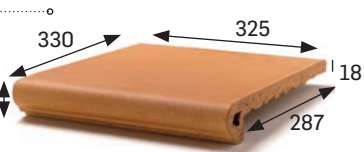

ESQUINA REDONDEADA

ROUNDED STAIR-TREAD CORNER
[330x330x53x18 mm]

Malí Cod. 901254 [PZ535]
Aneto Cod. 901989 [PZ535]
Arán Cod. 903062 [PZ535]

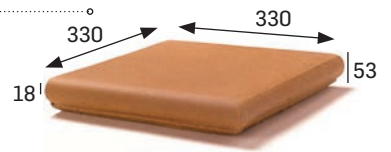

REMATE

EDGE
[325x275x65x25 mm]

Malí Cod. 901258 [PZ335] 65
Aneto Cod. 901994 [PZ335]

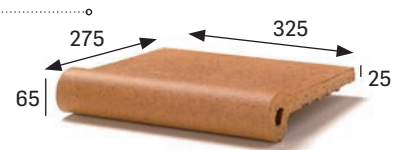

REMATE ESQ. EXT.

EXTERNAL CORNER
[275x275x65x24 mm]

Malí Cod. 901260 [PZ560] 65
Aneto Cod. 901996 [PZ560]

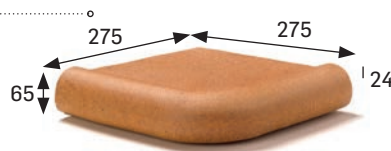

REMATE ESQ. INT.

INTERNAL CORNER
[325x275x65x24 mm]

Malí Cod. 901259 [PZ560] 65
Aneto Cod. 901995 [PZ560]

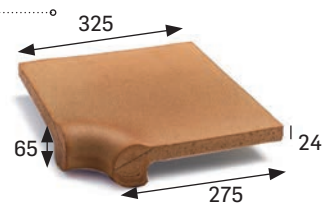

ZANQUÍN IZDA.

STRING LEFT SIDE
[390x80/200X100x16 mm]

Malí Cod. 901256 [PZ150] 200
Aneto Cod. 901991 [PZ150]
Arán Cod. 903063 [PZ150]

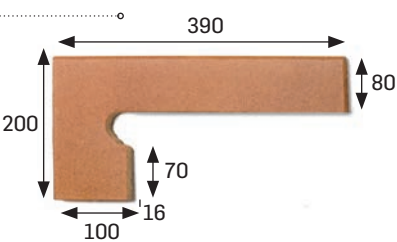

ZANQUÍN DCHA.

STRING RIGHT SIDE
[390x80/200X100x16 mm]

Malí Cod. 901255 [PZ150] 200
Aneto Cod. 901992 [PZ150]
Arán Cod. 903064 [PZ150]

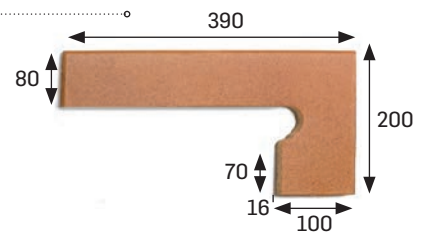

RODAPIÉ

SKIRTING BOARD
[325x80x16 mm]

Malí Cod. 901253 [ML150] 80
Aneto Cod. 901990 [ML150]
Arán Cod. 903061 [ML150]



VIERTEAGUAS 33X33

NATURAL WASH 33X33
[325x330x40x18 mm]

Malí Cod. 901257 [PZ245] 40
Aneto Cod. 901993 [PZ245]
Arán Cod. 903065 [PZ245]

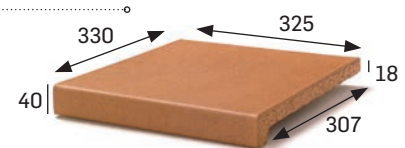

QUARRY

NATURALES NATURAL TILES

Colores / Colors

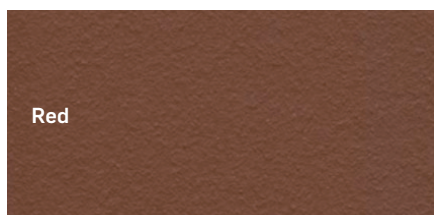

Red

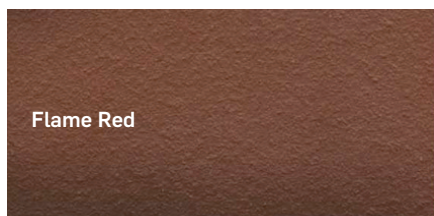

Flame Red

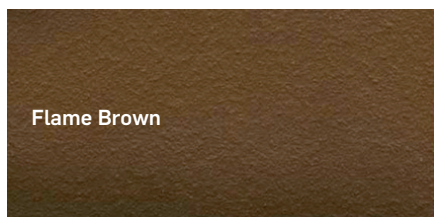

Flame Brown

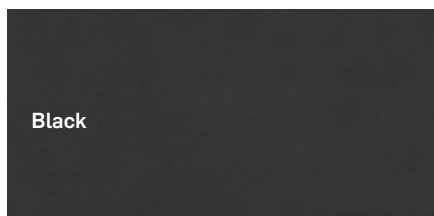

Black

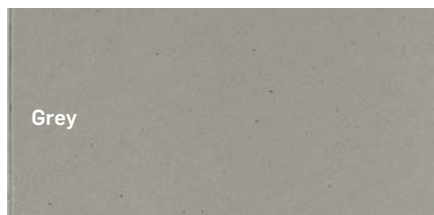

Grey

Los colores son indicativos.
Colors are just indicative.

142

PAVIMENTOS FLOOR TILES

(cm) Formatos / Sizes

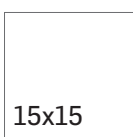

15x15

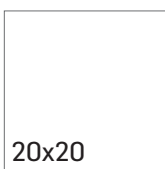

20x20

	NATURAL UNGLAZED	
	Características dimensionales Dimension tolerance	<1,25% máx 2 mm
	Absorción de agua Water absorption	3<E≤6%
	Coef. Dilatación termica lineal Linear thermal expansion coefficient	5,6x10 ⁻⁶ xC ⁻¹
	Resistencia a la flexión Breaking Strength	22 a 25 N/mm ²
	Resistencia a la abrasión profunda Resistance to deep abrasion	<393 mm ³
	Resistencia al rayado (Método Mohs) Scratch hardness of surface (Mohs Method)	7
	Resistencia a las manchas Resistance to stains	clase 3 a 5 class 3 to 5
	Péndulo (CTE) Not required out of Spain	clase 3 class 3
	A pie descalzo Barefoot slip resistance	C
	A pie calzado Slip resistance with footwear	R11 Antideslizante/Antislip R13
	Coefficiente fricción dinámico (DCOF) Dynamic coefficient of friction	0,73 Antideslizante/Antislip 0,85
	Extrusión Extruded tiles	✓
	Resistencia a la helada Frost resistance	✓
	Resistencia al choque térmico Resistance to thermal shock	✓
	Resistencia química Chemical resistance	✓

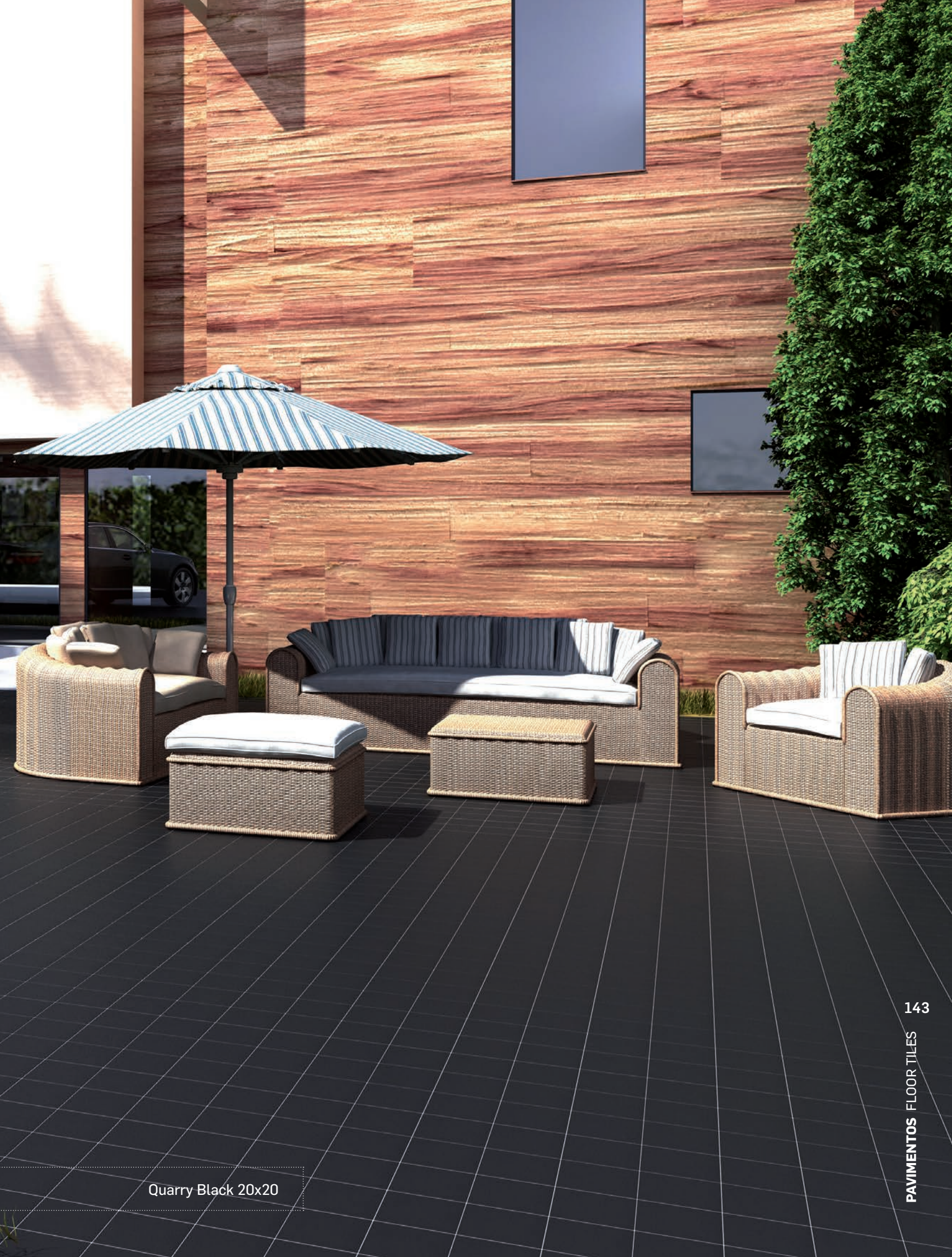

Quarry Black 20x20

QUARRY

NATURALES
NATURAL TILES

Colores / Colors



BASE 15x15 TILE 15x15

[150x150x12 mm]

Red	Cod. 902481 [MC580]
Flame Red	Cod. 902487 [MC580]
Flame Brown	Cod. 902499 [MC580]
Black	Cod. 904187 [MC700]
Black Anti-slip	Cod. 903945 [MC720]
Grey	Cod. 904795 [MC580]

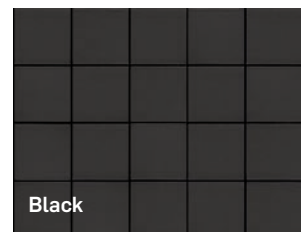
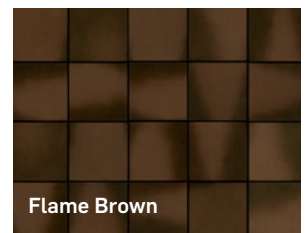
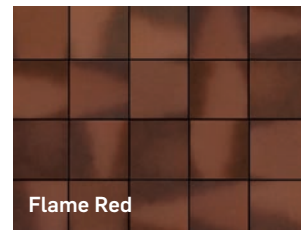
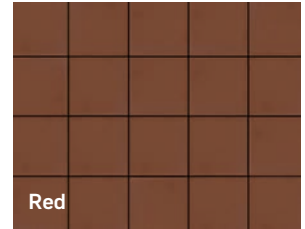
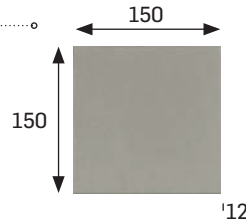

BASE 20x20 TILE 20x20

[195x195x13 mm]

Red	Cod. 903728 [MC475]
Black	Cod. 902651 [MC600]
Flame Brown	Cod. 902650 [MC475]

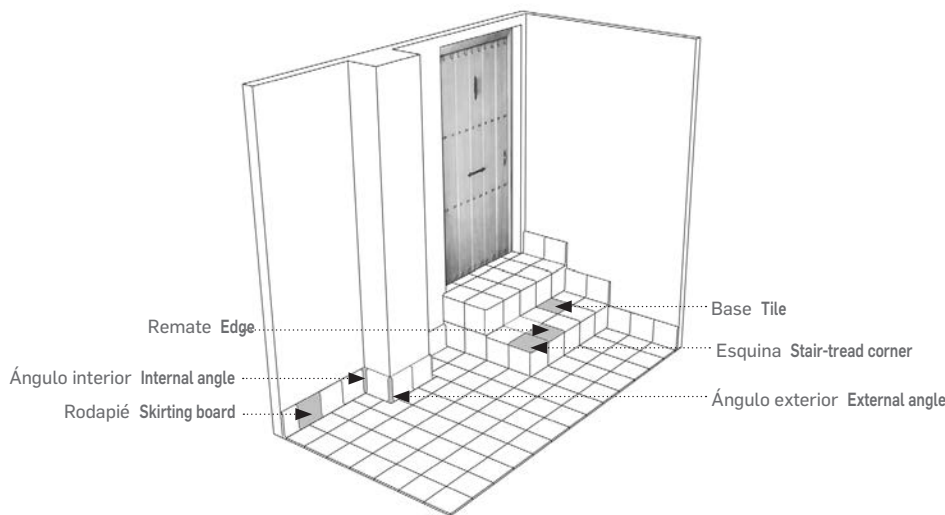
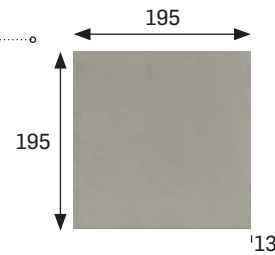

	Espeor (mm) Thickness (mm)	U.M.*	U.M./Caja U.M./Box	U.M./Palet U.M./Pallet	Pzs./U.M. Pcs./U.M.	Pzs./Caja Pcs./Box	Kg./U.M. Kg./U.M.	Kg./Caja Kg./Box	Kg./Palet Kg./Pallet
Base 15x15 Red / Flame red Tile 15x15 Red / Flame red	12	m ² sqm	0,55	46	42	23	25,9	14,2	1192
Base 15x15 Black / Black Anti-slip Tile 15x15 Black / Black Anti-slip	12	m ² sqm	0,528	46	42	22	23,9	13,1	1094
Base 15x15 Brown / Grey Tile 15x15 Brown	12	m ² sqm	0,55	46	42	23	23,9	13,1	1100
Base 20x20 Red/Flame brown Tile 20x20 Red / Flame brown	13	m ² sqm	0,84	50,4	25	21	28,01	23,6	1349,5
Base 20x20 Black Tile 20x20 Black	13	m ² sqm	0,80	48	25	20	28	22,40	1344

* Unidad de Medida. Los artículos medidos en m² o ml se sirven contando la junta normal entre piezas.

* Unit of Measure. Items measured in sqm or lm are delivered assuming average joint between pieces.



Quarry Flame Brown 20x20

QUARRY

NATURALES
NATURAL TILES

Colores / Colors



Quarry Red 20x20

	Espesor (mm) Thickness (mm)	U.M.*	U.M./Caja U.M./Box	U.M./Palet U.M./Pallet	Pzs./U.M. Pcs./U.M.	Pzs./Caja Pcs./Box	Kg./U.M. Kg./U.M.	Kg./Caja Kg./Box	Kg./Palet Kg./Pallet
Remate/RE15 Edge	12	Pz. Pc.	23	1932	1	23	0,59	13,57	1140
Remate/RE20 Black y Flame brown Black and Flame brown edge/RE20	13	Pz. Pc.	20	1200	1	20	1,22	24,4	1464
Remate/RE20 Red Red edge/RE20	13	Pz. Pc.	21	1260	1	21	1,13	23,70	1422
Esquina/REX 15 Red y Flame red Red and Flame red corner	12	Pz. Pc.	23	1932	1	23	0,59	13,57	1178
Esquina/REX 15 Black, Flame brown y Grey Black, Flame brown and Grey red corner	12	Pz. Pc.	23	1932	1	23	0,54	12,42	1043
Esquina/REX 20 Corner	13	Pz. Pc.	20	1200	1	20	1,22	24,4	1464
Rodapié 15 Red y Flame red Red and Flame red skirting board	12	Pz. Pc.	32	1280	1	32	0,50	16,00	640
Rodapié 15 Black, Flame brown y Grey Black, Flame brown and Grey skirting board	12	Pz. Pc.	32	1280	1	32	0,48	15,36	614,4
Rodapié 20 Red Red skirting board 20	14	Pz. Pc.	26	1040	1	26	0,64	16,64	665,6
Ángulo interior Red Red internal angle	12	Pz. Pc.	24	2688	1	24	0,12	2,88	322,5
Ángulo interior Black, Flame brown y Grey Black, Flame brown and Grey internal angle	12	Pz. Pc.	24	2688	1	24	0,12	2,88	322,5
Ángulo exterior Red y Flame red Red and Flame red external angle	12	Pz. Pc.	30	3360	1	30	0,05	1,5	168
Ángulo exterior Black, Flame brown y Grey Black, Flame brown and Grey external angle	12	Pz. Pc.	30	3360	1	30	0,05	1,5	168

* Unidad de Medida. Los artículos medidos en m² o ml se sirven contando la junta normal entre piezas.
* Unit of Measure. Items measured in sqm or lm are delivered assuming average joint between pieces.

Anchura recomendada de la junta de colocación: 4 - 5 mm
Recommended joint width 4 - 5 mm

Piezas especiales Special pieces

REMATE/RE15

EDGE 15

[150x150x12 mm]

Red	Cod. 902482	[PZ005]
Flame Red	Cod. 902488	[PZ005]
Flame Brown	Cod. 902500	[PZ005]
Black	Cod. 902561	[PZ015]
Black Anti-slip	Cod. 902640	[PZ020]
Grey	Cod. 904796	[PZ005]

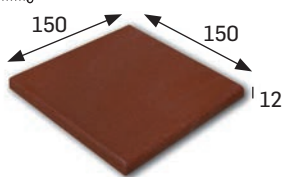

REMATE 20/RE20

EDGE 20

[195x195x13 mm]

Red	Cod. 903729	[PZ010]
Flame Brown	Cod. 902667	[PZ015]
Black	Cod. 902666	[PZ030]

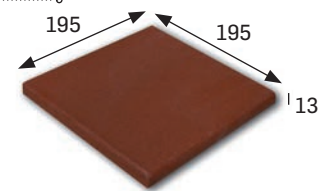

ESQUINA/REX 15

STAIR-TREAD CORNER 15

[150x150x12 mm]

Red	Cod. 902483	[PZ090]
Flame Red	Cod. 902489	[PZ090]
Flame Brown	Cod. 902501	[PZ090]
Black	Cod. 902562	[PZ105]
Black Anti-slip	Cod. 902641	[PZ125]
Grey	Cod. 904797	[PZ090]

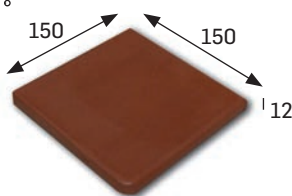

ESQUINA/REX 20

STAIR-TREAD CORNER 20

[195x195x13 mm]

Red	Cod. 902665	[PZ110]
Flame Brown	Cod. 902664	[PZ110]
Black	Cod. 902663	[PZ120]

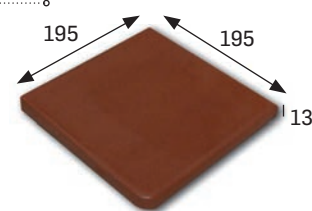

RODAPIÉ 15

SKIRTING BOARD 15

[150x114(110)x20 mm]*

Red	Cod. 902484	[PZ025]
Flame Red	Cod. 902490	[PZ025]
Flame Brown	Cod. 902502	[PZ025]
Black	Cod. 902563	[PZ040]
Grey	Cod. 904798	[PZ025]

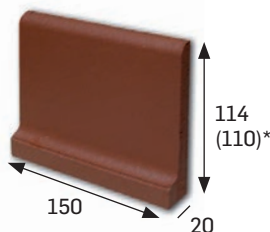

RODAPIÉ 20

SKIRTING BOARD 20

[195x114(110)x20 mm]

Red	Cod. 902662	[PZ040]
Flame Brown	Cod. 902661	[PZ040]
Black	Cod. 902660	[PZ060]



ÁNGULO INTERIOR

INTERNAL ANGLE

[114(110)x20x20 mm]*

Red	Cod. 902485	[PZ090]
Flame Brown	Cod. 902497	[PZ090]
Black	Cod. 902564	[PZ105]
Grey	Cod. 904799	[PZ090]

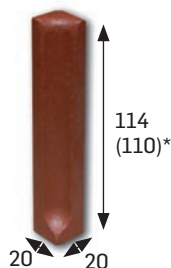

ÁNGULO EXTERIOR

EXTERNAL ANGLE

[114(110)x20x20 mm]*

Red	Cod. 902486	[PZ090]
Flame Brown	Cod. 902498	[PZ090]
Black	Cod. 902565	[PZ105]
Grey	Cod. 904800	[PZ090]

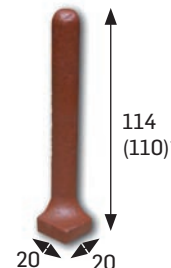

(*) Entre paréntesis las medidas especiales del color Red.
(*) In brackets special sizes for Red color.

COTTO

NATURALES NATURAL TILES

Colores / Colors

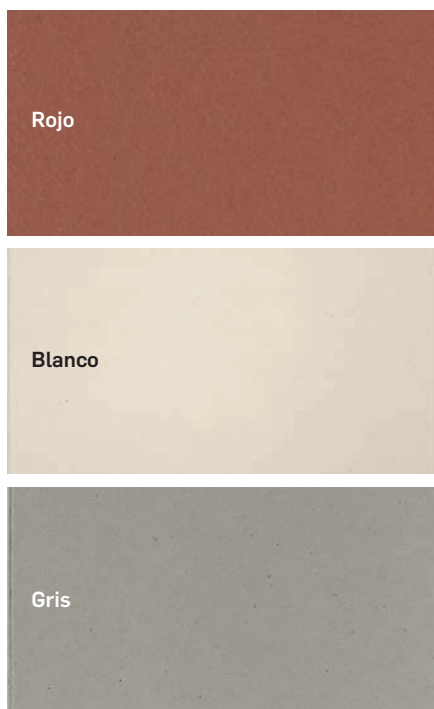

Los colores son indicativos.
Colors are just indicative.

(cm) Formatos / Sizes

6x25

12x25

25x25

33x33



NATURAL
UNGLAZED



Características dimensionales
Dimension tolerance

<1,25%
máx 2 mm



Absorción de agua
Water absorption

3<E≤6%



Coef. Dilatación termica lineal
Linear thermal expansion coefficient

3,8x10⁻⁶xC⁻¹



Resistencia a la flexión
Breaking Strength

20 a 25 N/mm²



Resistencia a la abrasión profunda
Resistance to deep abrasion

<393 mm³



Resistencia al rayado (Método Mohs)
Scratch hardness of surface (Mohs Method)

6



Resistencia a las manchas
Resistance to stains

clase 3 a 5
class 3 to 5



Péndulo (CTE)
Not required out of Spain

clase 3
class 3



A pie descalzo
Barefoot slip resistance

C



A pie calzado
Slip resistance with footwear

R11



Extrusión
Extruded tiles

✓



Resistencia a la helada
Frost resistance

✓



Resistencia al choque térmico
Resistance to thermal shock

✓



Resistencia química
Chemical resistance

✓



Cotto Rojo 33x33

COTTO

NATURALES
NATURAL TILES

Colores / Colors



BASE 6x25* TILE 6x25*

[62x244x10 mm]

Rojo Cod. 903840 [MC427]
Blanco Cod. 903841 [MC427]
Gris Cod. 903842 [MC427]

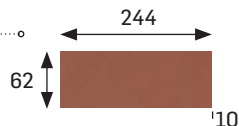

*Se obtiene a partir de base de 12x25 premarcada.
*It is obtained from 12x25 premarked tile.

BASE 12x25 TILE 12x25

[119x244x14 mm]

Rojo Cod. 901583 [MC410]
Blanco Cod. 901587 [MC410]
Gris Cod. 901589 [MC410]

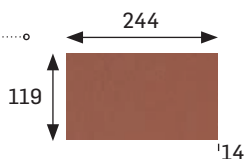

BASE 25x25 TILE 25x25

[244x244x14 mm]

Rojo Cod. 902635 [MC410]
Blanco Cod. 902675 [MC410]
Gris Cod. 902799 [MC410]

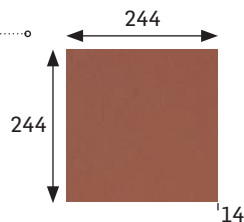

BASE 33x33 TILE 33x33

[325x325x16 mm]

Rojo Cod. 901547 [MC470]
Blanco Cod. 902683 [MC470]
Gris Cod. 902800 [MC470]

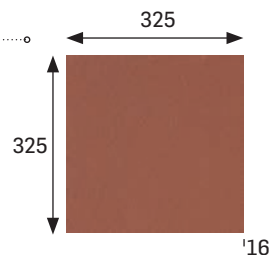

	Espesor (mm) Thickness (mm)	U.M.*	U.M./Caja U.M./Box	U.M./Palet U.M./Pallet	Pzs./U.M. Pcs./U.M.	Pzs./Caja Pcs./Box	Kg./U.M. Kg./U.M.	Kg./Caja Kg./Box	Kg./Palet Kg./Pallet
Base 6x25 (12x25 premarcada) Tile 6x25 (premarked tile 12x25)	10	m ² sqm	0,64	76,8	64	40	17	10,640	1276,8
Base 12x25 Tile 12x25	14	m ² sqm	1	60	32	16	26,3	13,2	1579
Base 25x25 Tile 25x25	14	m ² sqm	1	60	16	16	26	26	1560
Base 33x33 Tile 33x33	16	m ² sqm	0,666	42,624	9	6	33,2	22,1	1416
Tabica Cotto 12x25 Riser Cotto 12x25	14	Pz. Pc.	18**	-	1	18**	0,88	15,8	-
Tabica Cotto 14x33 Riser Cotto 12x33	16	Pz. Pc.	12**	-	1	12**	1,6	19,4	-
Rosetón 50x50 Mosaic 50x50	14	Jg. Set.	2	-	4	8	3,75	7,5	-
Rosetón 66x66 Mosaic 66x66	16	Jg. Set.	1	-	4	4	14,70	14,70	-

* Unidad de Medida. Los artículos medidos en m² o ml se sirven contando la junta normal entre piezas.
* Unit of Measure. Items measured in sqm or lm are delivered assuming average joint between pieces.

TABICA 12x25
 RISER 12X25
 [244x119x14 mm]

Tabica 1 Riser 1 12x25 **Cod. 901566** [PZ210]
Tabica 2 Riser 2 12x25 **Cod. 901567** [PZ210]

TABICA 14X33
 RISER 14x33
 [325x140x16 mm]

Tabica 1 Riser 1 14x33 **Cod. 901573** [PZ220]
Tabica 2 Riser 2 14x33 **Cod. 901574** [PZ220]

ROSETÓN 50X50
 [488x488x14 mm]

Rosetón 50x50 **Cod. 901565** [JG680]

ROSETÓN 66X66
 [650x650x16 mm]

Rosetón 66x66 **Cod. 901572** [JG735]



Tabica 1



Tabica 2



Cada rosetón se compone de 4 piezas. / Each rosetón is composed of 4 pieces.



Cotto Blanco 33x33

COTTO

NATURALES
NATURAL TILES

Colores / Colors



PELDAÑO REDONDEADO 25

ROUNDED STAIR-TREAD 25
[244x330x53x18 mm]

Rojo Cod. 902636 [PZ185]
Blanco Cod. 902676 [PZ185]
Gris Cod. 902802 [PZ185]

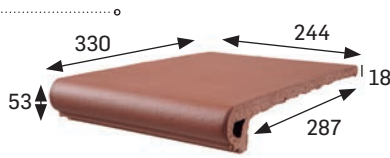

PELDAÑO REDONDEADO 33

ROUNDED STAIR-TREAD 33
[325x330x53x18 mm]

Rojo Cod. 902697 [PZ250]
Blanco Cod. 902684 [PZ250]
Gris Cod. 902801 [PZ250]



ESQUINA REDONDEADA

ROUNDED STAIR-TREAD CORNER
[330x330x53x18 mm]

Rojo Cod. 902638 [PZ480]
Blanco Cod. 902678 [PZ480]
Gris Cod. 902803 [PZ480]

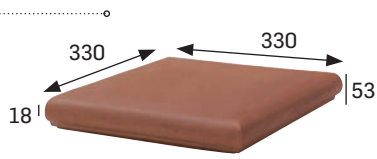

RODAPIÉ 33

SKIRTING BOARD 33
[325x80(76)x16 mm]

Rojo Cod. 902698 [ML155]
Blanco Cod. 902685 [ML155]
Gris Cod. 902806 [ML155]

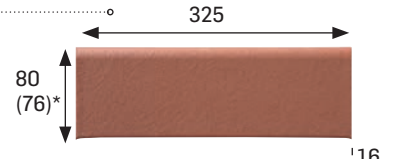

ZANQUÍN IZDA.

STRING LEFT SIDE
[390x80(76)/200X100x16 mm]

Rojo Cod. 902648 [PZ120]
Blanco Cod. 902679 [PZ120]
Gris Cod. 902804 [PZ120]

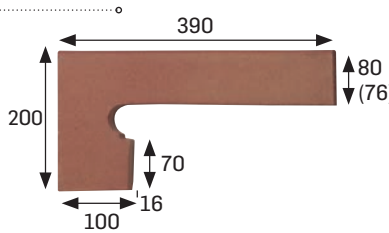

ZANQUÍN DCHA.

STRING RIGHT SIDE
[390x80(76)/200X100x16 mm]

Rojo Cod. 902649 [PZ120]
Blanco Cod. 902680 [PZ120]
Gris Cod. 902805 [PZ120]

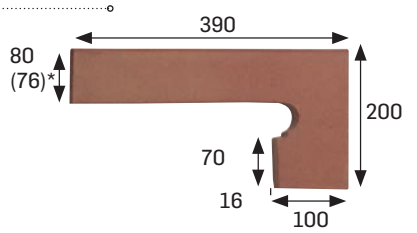

	Espesor (mm) Thickness (mm)	U.M.*	U.M./Caja U.M./Box	U.M./Palet U.M./Pallet	Pzs./U.M. Pcs./U.M.	Pzs./Caja Pcs./Box	Kg./U.M. Kg./U.M.	Kg./Caja Kg./Box	Kg./Palet Kg./Pallet
Peldaño redondeado 25 Rounded stair-tread 25	18	Pz. Pc.	6	324	1	6	3,4	20,4	1102
Peldaño redondeado 33 Rounded stair-tread 33	18	Pz. Pc.	6	216	1	6	4,4	26,4	950,4
Esquina redondeada Rounded stair-tread corner	18	Pz. Pc.	2	60	1	2	6	12	360
Rodapié 33 Skirting board 33	16	ml lm	8	576	3	24	2,3	18	1296
Zanquín Ref. 24 izda. String left	16	Pz. Pc.	10	300	1	10	1,3	13	390
Zanquín Ref. 24 dcha. String right	16	Pz. Pc.	10	300	1	10	1,3	13	390
Rodapié 25 Skirting board 25	14	ml lm	11,25 12♦	450 480♦	4 4	45 48♦	2,3 2,3♦	26 27,7♦	1038 1108♦
Pasamanos 21,5 Handrail 21,5	18	Pz. Pc.	5	300 420♦	1 1	5 7♦	2,6 2,6♦	13,2 18,55♦	804 1113♦
Pasamanos 12,5 Handrail 12,5	18	Pz. Pc.	11	396	1	11	1,9	20,9	752
Pasamanos redondeado Handrail	-	Pz. Pc.	6	240	1	6	2,35	14,10	564
Ángulo desigual Unequal edge	14	Pz. Pc.	16	896	1	16	1,19	14,6	876
Remate Edge	19	Pz. Pc.	4	168	1	4	4,95	19,8	831
Borde desbordante Overflowing edge	22-26	Pz. Pc.	4	128	1	4	5	20	640
Esq. int. borde desbordante Overflowing internal edge	26	Jg. Set	2	-	2	4	8	16	-
Esq. ext. borde desbordante Overflowing external edge	22	Jg. Set	2	-	2	4	5,4	10,8	-
Rejilla cerámica monocompact Monocompact ceramic grid	25	Pz. Pc.	6	378	1	6	3,58	21,5	-
Esquina rejilla Corner grid	25	Set Set	3	-	2	6	4,69	14,07	-
Canaleta Overflow channel	30	Pz. Pc.	3	99	1	3	4,43	13,3	438,6

Anchura recomendada de la junta de colocación: 6 - 8 mm
Recommended joint width 6 - 8 mm

(*) Entre paréntesis las medidas especiales del color Rojo.
(* In brackets special sizes for Rojo color.

♦ Embalaje especial color Rojo.
♦ Special packing Rojo color.

Piezas especiales Special pieces

RODAPIÉ 25

SKIRTING BOARD 25
[244x80(76)x14 mm]

Rojo Cod. 902637 [ML120]
Blanco Cod. 902677 [ML120]
Gris Cod. 902807 [ML120]

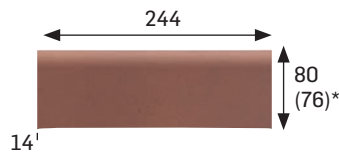

PASAMANOS INT. 21,5

HANDRAIL INT. 21,5
[251x244x46x18 mm]

Rojo Cod. 902745 [PZ180]
Blanco Cod. 902746 [PZ180]
Gris Cod. 902810 [PZ180]

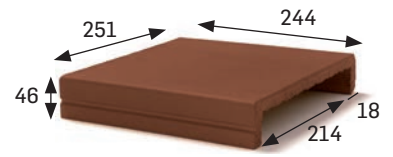

PASAMANOS INT. 12,5

HANDRAIL INT. 12,5
[244x160x40x18 mm]

Rojo Cod. 902742 [PZ145]
Blanco Cod. 902743 [PZ145]
Gris Cod. 902809 [PZ145]

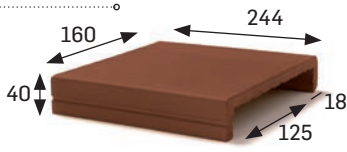

PASAMANOS REDONDEADO

HANDRAIL
[244x191(187)x54 mm]

Rojo Cod. 902699 [PZ175]
Blanco Cod. 902681 [PZ175]
Gris Cod. 902808 [PZ175]

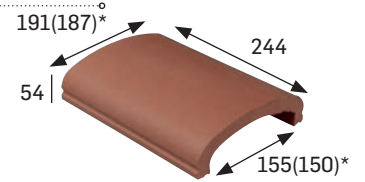

ÁNGULO DESIGUAL

UNEQUAL EDGE
[244x129(127)x60x14 mm]

Rojo Cod. 901590 [PZ115]
Blanco Cod. 901591 [PZ115]
Gris Cod. 901592 [PZ115]

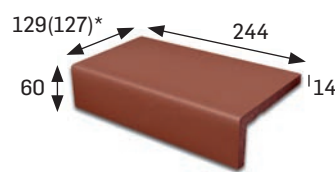

REMATE

EDGE
[325x270x55x19 mm]

Blanco Cod. 902767 [PZ335]
Gris Cod. 902811 [PZ335]

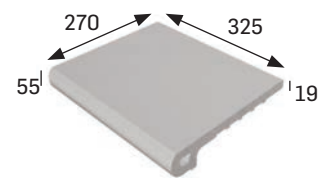

BORDE DESBORDANTE

OVERFLOWING EDGE
[325x330x26/22 mm]

Blanco Cod. 902794 [PZ225]
Gris Cod. 901985 [PZ225]

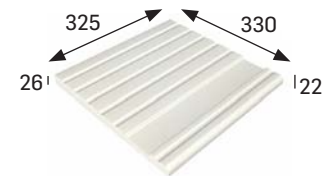

ESQ. INT. BORDE DESBORDANTE

OVERFLOWING INTERNAL EDGE
[330x444x119x26 mm]

Blanco Cod. 901936 [JG395]
Gris Cod. 901941 [JG395]

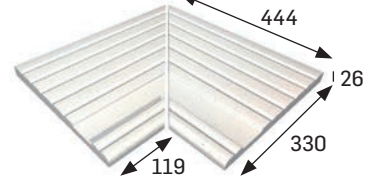

ESQ. EXT. BORDE DESBORDANTE

OVERFLOWING EXTERNAL EDGE
[330x353x26x22 mm]

Blanco Cod. 901937 [JG395]
Gris Cod. 901942 [JG395]

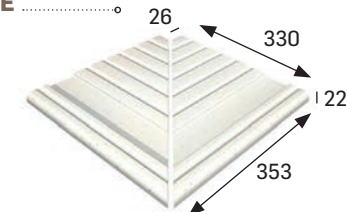

REJILLA CERÁMICA MONOCOMPACT

MONOCOMPACT CERAMIC GRID **
[325x244x25 mm]

Blanco Cod. 902973 [PZ645]
Gris Cod. 902974 [PZ645]

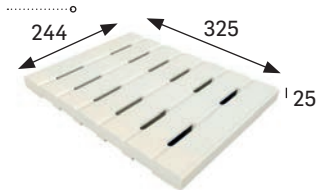

ESQUINA REJILLA

CORNER GRID **
[325x244x25x80 mm]

Blanco Cod. 901490 [JG750]
Gris Cod. 901491 [JG750]

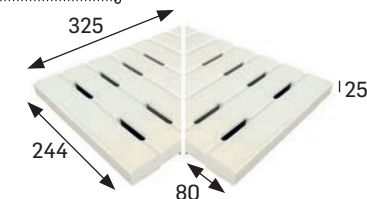

CANALETA

OVERFLOW CHANNEL *
[325x325x30 mm]

Blanco Cod. 901869 [PZ250]
Gris Cod. 901889 [PZ250]

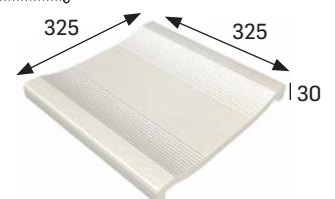

* Disponible Canaleta con desagüe.
* Overflow channel with drainage available.

** En rejillas los agujeros siempre deben ir perpendiculares al vaso para una mayor resistencia, con canal de 250 mm de ancho.

** Install the grids with the holes always perpendicular to the pool vessel to get a greater resistance, with a channel 250 mm wide.

JASPER

NATURALES NATURAL TILES

Colores / Colors

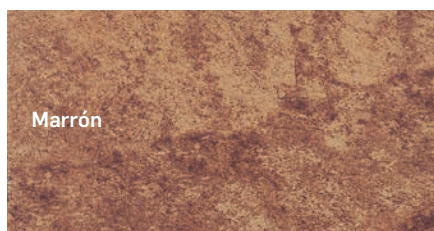

Marrón

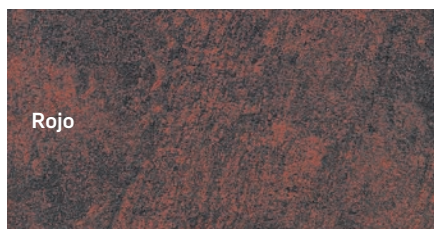















Rojo

Los colores son indicativos.
Colors are just indicative.

(cm) Formatos / Sizes



33x33

	NATURAL UNGLAZED	
	Características dimensionales Dimension tolerance	<1,25% máx 2 mm
	Absorción de agua Water absorption	3<E≤6%
	Coef. Dilatación termica lineal Linear thermal expansion coefficient	3,8x10 ⁻⁶ xC ⁻¹
	Resistencia a la flexión Breaking Strength	20 N/mm ²
	Resistencia a la abrasión profunda Resistance to deep abrasion	<393 mm ³
	Resistencia a las manchas Resistance to stains	clase 3 a 5 class 3 a 5
	Péndulo (CTE) Not required out of Spain	clase 3 class 3
	A pie descalzo Barefoot slip resistance	C
	A pie calzado Slip resistance with footwear	R11
	Extrusión Extruded tiles	✓
	Resistencia a la helada Frost resistance	✓
	Resistencia al choque térmico Resistance to thermal shock	✓
	Resistencia química Chemical resistance	✓



Jasper Rojo 33x33

JASPER

NATURALES
NATURAL TILES

Colores / Colors

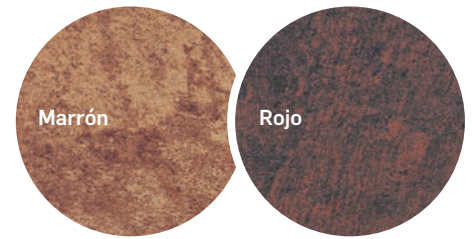

BASE 33x33 TILE 33x33

[325x325x16 mm]

Marrón Cod. 901634 [MC510]
Rojo Cod. 901635 [MC510]

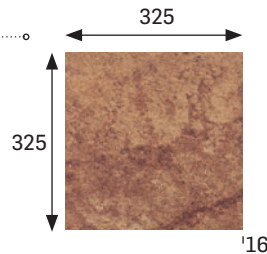

Piezas especiales Special pieces

PELDAÑO REDONDEADO 33

ROUNDED STAIR-TREAD 33

[325x330x53x18 mm]

Marrón Cod. 901637 [PZ275]
Rojo Cod. 901638 [PZ275]

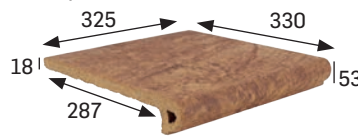

ESQUINA REDONDEADA

ROUNDED STAIR-TREAD CORNER

[330x330x53x18 mm]

Marrón Cod. 901640 [PZ555]
Rojo Cod. 901641 [PZ555]

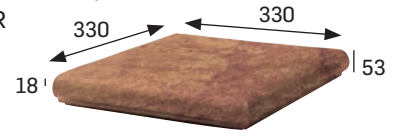

ZANQUÍN IZDA.

STRING LEFT SIDE

[390x80/200x100x16 mm]

Marrón Cod. 901643 [PZ160]
Rojo Cod. 901644 [PZ160]

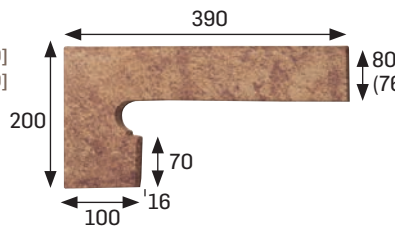

ZANQUÍN DCHA.

STRING RIGHT SIDE

[390x80/200x100x16 mm]

Marrón Cod. 901646 [PZ160]
Rojo Cod. 901647 [PZ160]

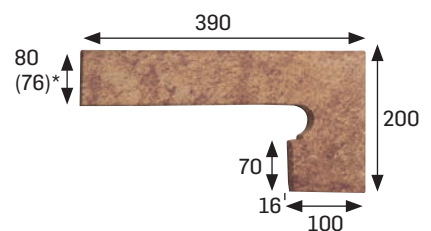

(*) Entre paréntesis las medidas especiales del color Rojo.
(*) In brackets special sizes for Rojo color.

RODAPIÉ

SKIRTING BOARD

[325x80(76)x16 mm]

Marrón Cod. 901649 [ML160]
Rojo Cod. 901650 [ML160]



156

PAVIMENTOS FLOOR TILES

	Espesor (mm) Thickness (mm)	U.M.*	U.M./Caja U.M./Box	U.M./Palet U.M./Pallet	Pzs./U.M. Pcs./U.M.	Pzs./Caja Pcs./Box	Kg./U.M. Kg./U.M.	Kg./Caja Kg./Box	Kg./Palet Kg./Pallet
Base 33x33 Tile 33x33	16	m ² sqm	0,666	42,624	9	6	32,6	21,75	1391
Peldaño redondeado 33 Rounded stair-tread 33	18	Pz. Pc.	6	216	1	6	4,2	26,4	950
Esquina redondeada Rounded stair-tread corner	18	Pz. Pc.	2	60	1	2	6	12	360
Zanquín izda. String left	16	Pz. Pc.	10	300	1	10	1,3	13	390
Zanquín dcha. String right	16	Pz. Pc.	10	300	1	10	1,3	13	390
Rodapié Skirting board	16	ml lm	8	576	3	24	2,3	18,4	1325

* Unidad de Medida. Los artículos medidos en m² o lm se sirven contando la junta normal entre piezas.
* Unit of Measure. Items measured in sqm or lm are delivered assuming average joint between pieces.

Anchura recomendada de la junta de colocación: 6 - 8 mm
Recommended joint width 6 - 8 mm



Jasper Marrón 33x33



ACEPOOL

WELLNESS CERAMICS - GRES ARAGON



ACEPOOL es la marca de cerámica para **piscinas** de interior y exterior, deportivas, instalaciones wellness y balnearias. Gracias a nuestro amor por el detalle y al exclusivo **catálogo de piezas especiales** de acabado, nos adaptamos a las necesidades técnicas de cada proyecto y las preferencias de nuestros clientes.

En Gres Aragón **nos gusta ofrecer seguridad, higiene, durabilidad y resistencia** con nuestros materiales. Por eso nuestros **pavimentos, escaleras, terrazas y piscinas** tienen alta resistencia al tránsito, son antibacterianos, impermeables y antideslizantes. Están hechos para durar.

En Gres Aragón también **cuidamos de la Tierra y de nuestra tierra**. Estamos comprometidos mediante una gestión sostenible de nuestros productos, la generación de 0 residuos, la fijación de la población rural y compartiendo la riqueza en nuestro entorno.

Y, sobre todo, en Gres Aragón **nos gustan los desafíos**, cada nuevo proyecto, cada nuevo cliente, es una oportunidad para adaptarnos a sus necesidades y... sus sueños.

ACEPOOL is our tile brand for indoor and outdoor pools, sports pools, wellbeing facilities and spas. Thanks to our passion for detail and our **exclusive range of special tile pieces**, we have products able to fit in with all possible preferences and to meet the technical needs of each and every project.

At Gres Aragón, **we guarantee hygiene, safety, durability and a high resistance. Floors, stairs, terraces and swimming pools** clad in our products stand out for their high resistance to traffic, imperviousness, anti-bacterial properties and non-slip grip. Our products are made to last.

At Gres Aragón, we also **care for the planet and the local environment**. Through sustainable management of our products, we are committed to zero waste, the maintenance of the rural population and to sharing wealth locally.

And, above all, at Gres Aragón, we **love to be faced with new challenges**. Each new project and each new client is an opportunity to demonstrate our ability to meet their needs and to make their dreams come true.

PISCINA PÚBLICA RECREATIVA Y PRIVADA PUBLIC RECREATIONAL AND PRIVATE POOL

PORCELÁNICOS PORCELAIN TILES

Colores / Colors









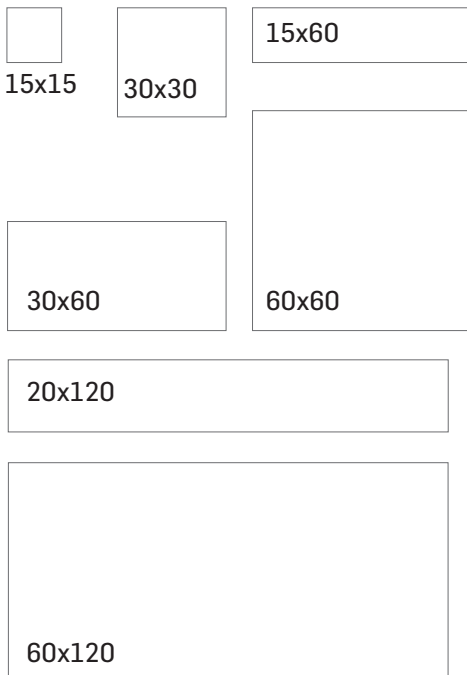









160

PISCINA PÚBLICA RECREATIVA Y PRIVADA PUBLIC RECREATIONAL AND PRIVATE POOL

(cm) Formatos / Sizes



 PORCELÁNICO PORCELAIN	
 ESMALTADO GLAZED	
 Absorción de agua Water absorption	E≤0,5%
 Resistencia a las manchas Resistance to stains	clase 5 class 5
 Péndulo (CTE) Not required out of Spain	Urban, Ítaca, Ordesa, Marble Ocean, Tibet Mate/Matt class 3 Urban, Ordesa, Tibet, Marble Liso/smooth class 1 Ocean 15x15 brillo/glossy class 0
 A pie descalzo Barefoot slip resistance	Urban, Ítaca, Ordesa, Marble Tibet, Ocean Mate/Matt C Urban, Ordesa, Tibet, Marble Liso/smooth Ocean A
 A pie calzado Slip resistance with footwear	Urban, Ítaca, Ordesa, Marble Tibet, Ocean Mate/Matt class R11 Urban, Ordesa, Tibet, Marble Liso/smooth class class R9 Ocean brillo/glossy class class <R9
 Resistencia al cuarteo Crazing resistance	sí/yes
 Resistencia a la abrasión superficial Resistance to surface abrasion	PEI 2 a/to 4 según color depending on color
 Resistencia a la helada Frost resistance	✓
 Resistencia al choque térmico Resistance to thermal shock	✓
 Resistencia química Chemical resistance	✓
 Destonificado Shade variation	Urban V2 ligero light
 Destonificado Shade variation	Tibet, Marble, Ordesa, Ocean V3 moderado mild
 Destonificado Shade variation	Ítaca V4 considerable substantial
 Antibacteriano Antibacterian	R>2 Reducción antibacteriana >99 % Excepto 15x15 brillo except 15x15 glossy



Urban Gris 30x60

BASES

PORCELÁNICAS
PORCELAIN TILES



BASE 15x15 TILE 15x15

[147x147x8,5 mm]

Brillo/Glossy

- Ocean Blue Bali** Cod. 905573 [MC583]
- Ocean Coral Bay** Cod. 905498 [MC583]
- Ocean Green River** Cod. 905499 [MC583]
- Ocean Pearl** Cod. 905501 [MC583]

Mate/Matt

- Ocean Blue Bali** Cod. 905574 [MC583]
- Ocean Coral Bay** Cod. 905502 [MC583]
- Ocean Green River** Cod. 905503 [MC583]
- Ocean Pearl** Cod. 905505 [MC583]

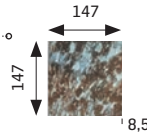

Urban Blanco



Ítaca Mix

BASE 30x30 TILE 30x30

[297x297x10 mm]

Antideslizante / Anti slip

- Urban Blanco** Cod. 904237 [MC479]
- Urban Gris** Cod. 904238 [MC479]
- Urban Beige** Cod. 904239 [MC479]
- Urban Caoba** Cod. 905634 [MC479]
- Urban Grafito** Cod. 904763 [MC479]
- Ítaca Gris** Cod. 904075 [MC479]
- Ítaca Mix** Cod. 904079 [MC479]
- Tibet Blanco** Cod. 904911 [MC479]
- Tibet Gris** Cod. 904912 [MC479]
- Tibet Beige** Cod. 904913 [MC479]
- Tibet Antracita** Cod. 904914 [MC479]

Mate/Matt

- Ocean Blue Bali** Cod. 905565 [MC479]
- Ocean Coral Bay** Cod. 904803 [MC479]
- Ocean Green River** Cod. 904802 [MC479]
- Ocean Pearl** Cod. 905273 [MC479]

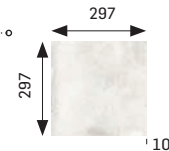

Ítaca Gris



Ordesa Marrón

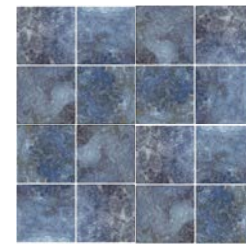

Ocean Blue Bali

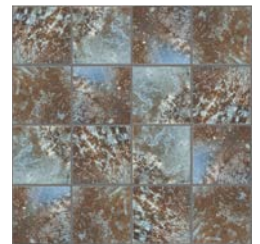

Ocean Coral Bay

BASE 15x60 TILE 15x60

[147x597x10 mm]

Antideslizante / Anti slip

- Ordesa Gris** Cod. 904623 [MC520]
- Ordesa Beige** Cod. 904624 [MC520]
- Ordesa Natural** Cod. 905506 [MC520]
- Ordesa Marrón** Cod. 904625 [MC520]

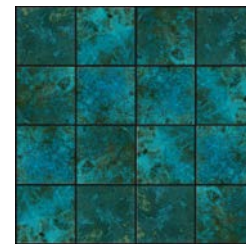

Ocean Green River

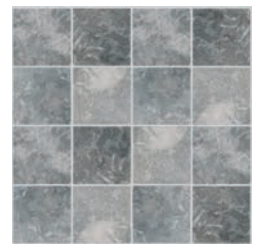

Ocean Pearl

	Espesor (mm) Thickness (mm)	U.M.*	U.M./Caja U.M./Box	U.M./Palet U.M./Pallet	Pzs./U.M. Pcs./U.M.	Pzs./Caja Pcs./Box	Kg./U.M. Kg./U.M.	Kg./Caja Kg./Box	Kg./Palet Kg./Pallet
Base 15x15 Tile 15x15	8,5	m ² sqm	0,72	60,48	44,44	32	18,49	13,32	1118,6
Base 30x30 Tile 30x30	10	m ² sqm	0,99	71,29	11,11	11	21,54	21,33	1536
Base 15x60 Tile 15x60	10	m ² sqm	0,99	71,28	11,11	11	21,54	21,33	1536
Base 30x60 Tile 30x60	10	m ² sqm	1,08	64,86	5,55	6	21,65	23,38	1403
Base 60x60 Tile 60x60	10	m ² sqm	1,44	60,48	2,78	4	22,53	32,44	1362,5
Base 20x120 Tile 20x120	10,4	m ² sqm	0,95	45,73	4,2	4	23,41	22,2	1060
Base 60x120 Tile 60x120	10,4	m ² sqm	1,45	43,5	1,37	2	25,08	34,6	1017

* Unidad de Medida. Los artículos medidos en m² o ml se sirven contando la junta normal entre piezas.
* Unit of Measure. Items measured in sqm or lm are delivered assuming average joint between pieces.

Anchura recomendada de la junta de colocación: Consultar pág. 15.
Recommended joint width: See pg. 15.

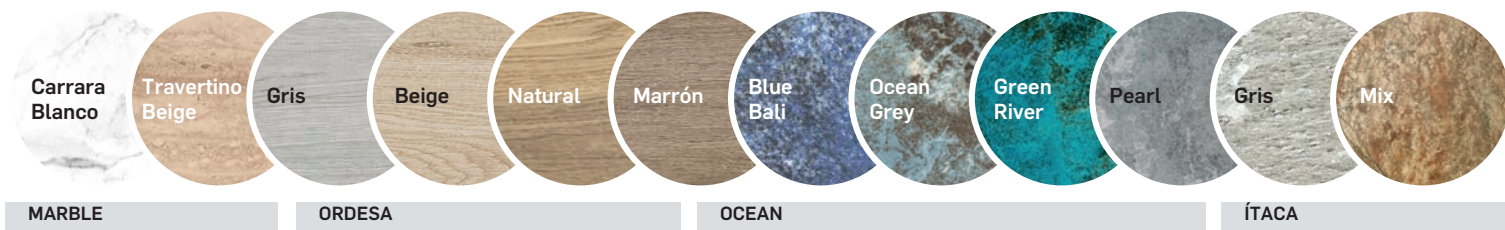

BASE 30x60 TILE 30x60

[297x597x10 mm]

Antideslizante / Anti slip

Urban Blanco	Cod. 904245	[MC479]
Urban Gris	Cod. 904246	[MC479]
Urban Beige	Cod. 904247	[MC479]
Urban Caoba	Cod. 905635	[MC479]
Urban Grafito	Cod. 904765	[MC479]
Ítaca Gris	Cod. 904089	[MC479]
Ítaca Mix	Cod. 904093	[MC479]
Tibet Blanco	Cod. 904919	[MC479]
Tibet Gris	Cod. 904920	[MC479]
Tibet Beige	Cod. 904921	[MC479]
Tibet Antracita	Cod. 904922	[MC479]
Carrara Blanco	Cod. 905537	[MC479]
Travertino Beige	Cod. 905538	[MC479]



Liso / Smooth

Urban Caoba	Cod. 905636	[MC479]
--------------------	-------------	---------

BASE 20x120 TILE 20x120

[195x1200x10,4 mm] rectificada/rectified

Antideslizante / Anti slip

Ordesa Gris	Cod. 904715	[MC567]
Ordesa Beige	Cod. 904716	[MC567]
Ordesa Natural	Cod. 905508	[MC567]
Ordesa Marrón	Cod. 904717	[MC567]



Liso / Smooth

Ordesa Gris	Cod. 905159	[MC567]
Ordesa Beige	Cod. 905160	[MC567]
Ordesa Natural	Cod. 905507	[MC567]
Ordesa Marrón	Cod. 905161	[MC567]

BASE 60x60 TILE 60x60

[597x597x10 mm]

Antideslizante / Anti slip

Urban Blanco	Cod. 904253	[MC479]
Urban Gris	Cod. 904254	[MC479]
Urban Beige	Cod. 904255	[MC479]
Urban Caoba	Cod. 905637	[MC479]
Urban Grafito	Cod. 904767	[MC479]
Ítaca Gris	Cod. 904129	[MC479]
Ítaca Mix	Cod. 904133	[MC479]

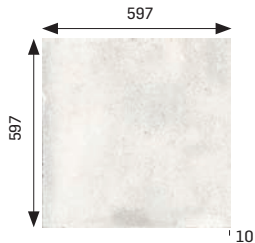

Liso / Smooth

Urban Blanco	Cod. 904249	[MC479]
Urban Gris	Cod. 904250	[MC479]
Urban Beige	Cod. 904251	[MC479]
Urban Caoba	Cod. 905638	[MC479]
Urban Grafito	Cod. 904766	[MC479]

BASE 60x120 TILE 60x120

[600x1200x10,4 mm]

Antideslizante / Anti slip

Urban Blanco	Cod. 905234	[MC567]
Urban Gris	Cod. 905233	[MC567]
Urban Beige	Cod. 905236	[MC567]
Urban Grafito	Cod. 905235	[MC567]
Tibet Blanco	Cod. 905247	[MC567]
Tibet Gris	Cod. 905246	[MC567]
Tibet Beige	Cod. 905248	[MC567]
Tibet Antracita	Cod. 905249	[MC567]
Carrara Blanco	Cod. 905539	[MC567]
Travertino Beige	Cod. 905540	[MC567]

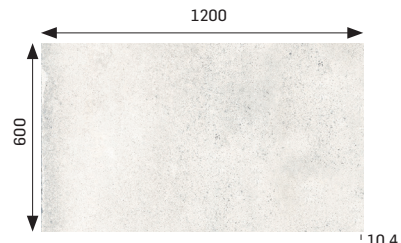

Liso / Smooth

Urban Blanco	Cod. 904723	[MC567]
Urban Gris	Cod. 904722	[MC567]
Urban Beige	Cod. 904873	[MC567]
Urban Grafito	Cod. 904874	[MC567]
Tibet Blanco	Cod. 904931	[MC567]
Tibet Gris	Cod. 904932	[MC567]
Tibet Beige	Cod. 904933	[MC567]
Tibet Antracita	Cod. 904934	[MC567]
Carrara Blanco	Cod. 905541	[MC567]
Travertino Beige	Cod. 905542	[MC567]

PIEZAS ESPECIALES SPECIAL PIECES

PORCELÁNICAS PORCELAIN TILES



PELDAÑO RECTO 30

STRAIGHT STAIR-TREAD 30

Antideslizante · Anti slip
[297x315x14 mm]

- Tibet Blanco** Cod. 970119 [PZ287]
- Tibet Gris** Cod. 970120 [PZ287]
- Tibet Beige** Cod. 970121 [PZ287]
- Tibet Antracita** Cod. 970122 [PZ287]

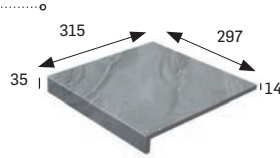

PELDAÑO RECTO 60

STRAIGHT STAIR-TREAD 60

Antideslizante · Anti slip
[597x315x14 mm]

- Urban Blanco** Cod. 970023 [PZ603]
- Urban Gris** Cod. 970024 [PZ603]
- Urban Beige** Cod. 970025 [PZ603]
- Urban Grafito** Cod. 970090 [PZ603]
- Ordesa Gris** Cod. 970064 [PZ603]
- Ordesa Beige** Cod. 970065 [PZ603]
- Ordesa Natural** Cod. 970175 [PZ603]
- Ordesa Marrón** Cod. 970066 [PZ603]

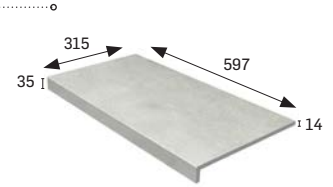

PELDAÑO RECTO 120

STRAIGHT STAIR-TREAD 120

Antideslizante · Anti slip
[1197x315x14 mm]

- Urban Blanco** Cod. 970095 [PZ724]
- Urban Gris** Cod. 970096 [PZ724]
- Urban Beige** Cod. 970097 [PZ724]
- Urban Grafito** Cod. 970091 [PZ724]
- Ítaca Gris** Cod. 970099 [PZ724]
- Ítaca Mix** Cod. 970098 [PZ724]
- Ordesa Gris** Cod. 970067 [PZ724]
- Ordesa Beige** Cod. 970068 [PZ724]
- Ordesa Natural** Cod. 970176 [PZ724]
- Ordesa Marrón** Cod. 970069 [PZ724]
- Tibet Blanco** Cod. 970127 [PZ724]
- Tibet Gris** Cod. 970128 [PZ724]
- Tibet Beige** Cod. 970129 [PZ724]
- Tibet Antracita** Cod. 970130 [PZ724]
- Carrara Blanco** Cod. 970178 [PZ724]
- Travertino Beige** Cod. 970179 [PZ724]

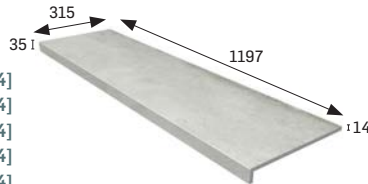

ESQUINA RECTA

STRAIGHT STAIR-TREAD CORNER

Antideslizante · Anti slip
[315x315x40x14 mm]

- Tibet Blanco** Cod. 904951 [PZ715]
- Tibet Gris** Cod. 904952 [PZ715]
- Tibet Beige** Cod. 904953 [PZ715]
- Tibet Antracita** Cod. 904954 [PZ715]

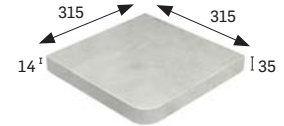

164

PISCINA PÚBLICA RECREATIVA Y PRIVADA PUBLIC RECREATIONAL AND PRIVATE POOL



	Espesor (mm) Thickness (mm)	U.M.*	U.M./Caja U.M./Box	U.M./Palet U.M./Pallet	Pzs./U.M. Pcs./U.M.	Pzs./Caja Pcs./Box	Kg./U.M. Kg./U.M.	Kg./Caja Kg./Box	Kg./Palet Kg./Pallet
Peldaño recto 30 Straight stair-tread 30	14	Pz. Pc.	4	256	1	4	3,1	12,6	806
Peldaño recto 60 Straight stair-tread 60	14	Pz. Pc.	4	144	1	4	5,8	23,4	842
Peldaño recto 120 Straight stair-tread 120	14	Pz. Pc.	2	32	1	2	11,32	22,6	362,2
Esquina recta Straight stair-tread corner	14	Pz. Pc.	2	60	1	2	3,5	7	420
Rejilla monocompact ranurada Monocompact grooved grid	25	Pz. Pc.	5	315	1	5	4,2	20,8	1310
Esquina rejilla Corner grid	25	Set Set	1	-	1	2	7,96	7,96	-
Rejilla flexible ranurada Grooved Flexible grid	25	Pz. Pc.	1	30	1	1	12,7	12,7	381
Canto romo Bull nose	8,5	m² sqm	0,71	59,72	42,19	30	19,79	14,07	1182

* Unidad de Medida. Los artículos medidos en m² o ml se sirven contando la junta normal entre piezas.
* Unit of Measure. Items measured in sqm or lm are delivered assuming average joint between pieces.

Anchura recomendada de la junta de colocación: Consultar pág. 15.
Recommended joint width: See pg. 15.

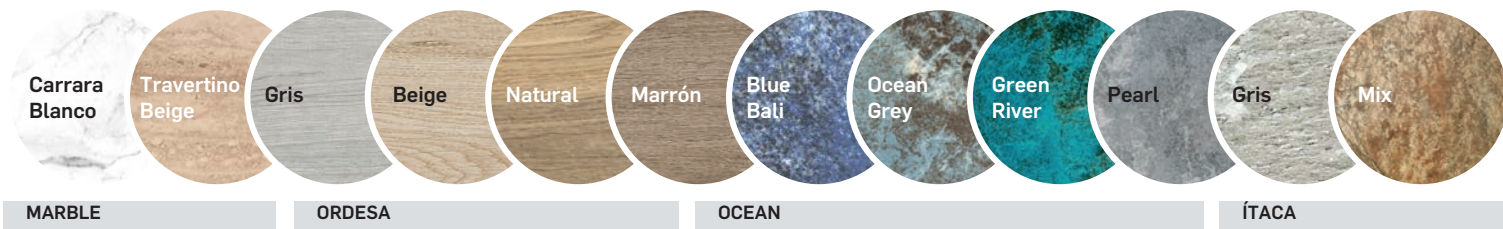

REJILLA MONOCOMPACT RANURADA

MONOCOMPACT GROOVED GRID

Antideslizante / Anti slip **
[291x244x25 mm]

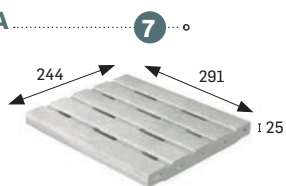

Urban Blanco	Cod. 905056	[PZ595]
Urban Gris	Cod. 904909	[PZ595]
Urban Beige	Cod. 905058	[PZ595]
Urban Grafito	Cod. 905059	[PZ595]
Ítaca Gris	Cod. 905044	[PZ595]
Ítaca Mix	Cod. 905045	[PZ595]
Ordesa Gris	Cod. 904659	[PZ595]
Ordesa Beige	Cod. 905038	[PZ595]
Ordesa Natural	Cod. 905526	[PZ595]
Ordesa Marrón	Cod. 905037	[PZ595]
Tibet Blanco	Cod. 904995	[PZ595]
Tibet Gris	Cod. 904996	[PZ595]
Tibet Beige	Cod. 904997	[PZ595]
Tibet Antracita	Cod. 904998	[PZ595]

** En rejillas, los agujeros siempre deben ir paralelos al vaso para su mayor resistencia, con canal de 250 mm de ancho.

** Install the grids with the holes always parallel to the pool vessel to get a greater resistance, with a channel 250 mm wide

REJILLA FLEXIBLE RANURADA

GROOVED FLEXIBLE GRID *

Antideslizante · Anti slip
[245x25 x52 mm]



Urban Blanco	Cod. 905048	[ML780]
Urban Gris	Cod. 905049	[ML780]
Urban Beige	Cod. 905050	[ML780]
Urban Grafito	Cod. 905051	[ML780]
Ítaca Gris	Cod. 905042	[ML780]
Ítaca Mix	Cod. 905043	[ML780]
Ordesa Gris	Cod. 904908	[ML780]
Ordesa Beige	Cod. 905035	[ML780]
Ordesa Natural	Cod. 905528	[ML780]
Ordesa Marrón	Cod. 905036	[ML780]
Tibet Blanco	Cod. 905003	[ML780]
Tibet Gris	Cod. 905004	[ML780]
Tibet Beige	Cod. 905005	[ML780]
Tibet Antracita	Cod. 905006	[ML780]

* Disponible bajo pedido. / Available on demand.

Ver/See pg. 14.

ESQUINA REJILLA

CORNER GRID

Antideslizante · Anti slip
[388x244x25 x144 mm]

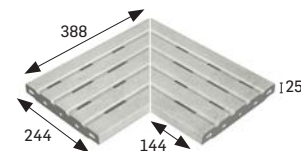

Urban Blanco	Cod. 905052	[JG761]
Urban Gris	Cod. 905053	[JG761]
Urban Beige	Cod. 905054	[JG761]
Urban Grafito	Cod. 905055	[JG761]
Ítaca Gris	Cod. 905046	[JG761]
Ítaca Mix	Cod. 905047	[JG761]
Ordesa Gris	Cod. 905039	[JG761]
Ordesa Beige	Cod. 905040	[JG761]
Ordesa Natural	Cod. 905527	[JG761]
Ordesa Marrón	Cod. 905041	[JG761]
Tibet Blanco	Cod. 904999	[JG761]
Tibet Gris	Cod. 905000	[JG761]
Tibet Beige	Cod. 905001	[JG761]
Tibet Antracita	Cod. 905002	[JG761]

CANTO ROMO

BULLNOSE

[147x148x8 mm]
Brillo/Glossy

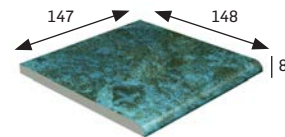

Ocean Blue Bali	Cod. 905778	[PZ085]
Ocean Coral Bay	Cod. 905188	[PZ085]
Ocean Green River	Cod. 905186	[PZ085]
Ocean Pearl	Cod. 905272	[PZ085]
Mate/Matt		
Ocean Blue Bali	Cod. 905566	[PZ085]
Ocean Coral Bay	Cod. 905185	[PZ085]
Ocean Green River	Cod. 905183	[PZ085]
Ocean Pearl	Cod. 905271	[PZ085]



PIEZAS ESPECIALES SPECIAL PIECES

PORCELÁNICAS PORCELAIN TILES



CANALETA*

OVERFLOW CHANNEL

Antideslizante · Anti slip
[297x244x30 mm]

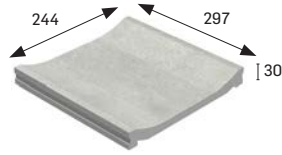

Urban Blanco	Cod. 904337	[PZ382]
Urban Gris	Cod. 904338	[PZ382]
Urban Beige	Cod. 904339	[PZ382]
Urban Grafito	Cod. 904787	[PZ382]
Ítaca Gris	Cod. 903019	[PZ382]
Ítaca Mix	Cod. 903017	[PZ382]
Ordesa Gris	Cod. 904668	[PZ382]
Ordesa Beige	Cod. 904669	[PZ382]
Ordesa Natural	Cod. 905529	[PZ382]
Ordesa Marrón	Cod. 904670	[PZ382]
Tibet Blanco	Cod. 905007	[PZ382]
Tibet Gris	Cod. 905008	[PZ382]
Tibet Beige	Cod. 905009	[PZ382]
Tibet Antracita	Cod. 905010	[PZ382]

* Disponible Canaleta con desagüe.
* Overflow channel with drainage available.



166

PISCINA PÚBLICA RECREATIVA Y PRIVADA PUBLIC RECREATIONAL AND PRIVATE POOL

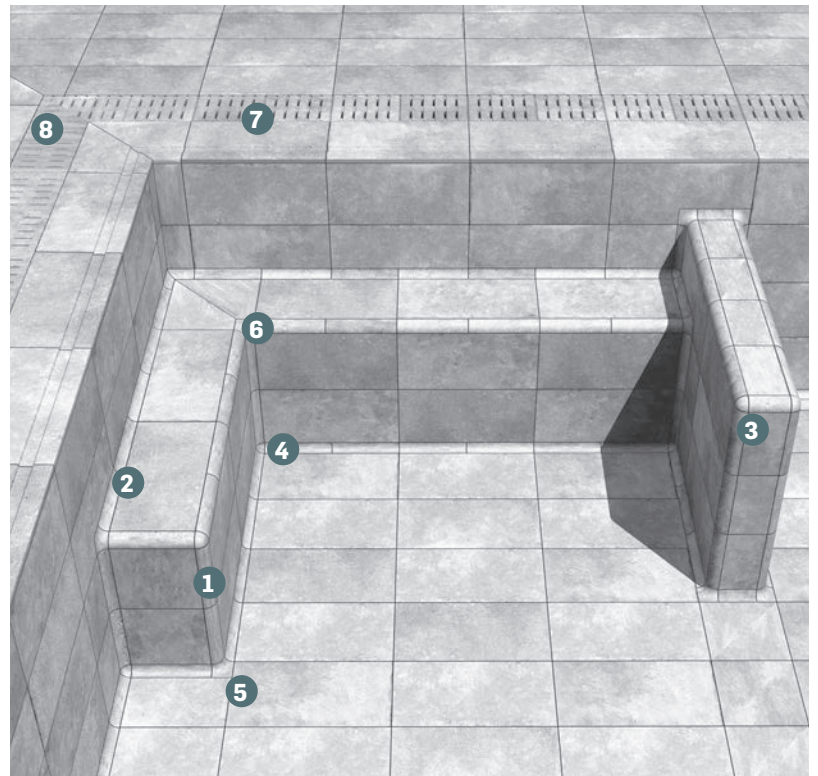

	Espesor (mm) Thickness (mm)	U.M.*	U.M./Caja U.M./Box	U.M./Palet U.M./Pallet	Pzs./U.M. Pcs./U.M.	Pzs./Caja Pcs./Box	Kg./U.M. Kg./U.M.	Kg./Caja Kg./Box	Kg./Palet Kg./Pallet
Canaleta Overflow channel	30	Pz. Pc.	4	288	1	4	2,5	10,2	734
Cantonera External radial angle	-	Pz. Pc.	42	1512	1	42	0,34	14,5	522
Rinconera Internal radial angle	-	Pz. Pc.	35	1260	1	35	0,41	14,2	511
Esq. exterior cantonera External mitre	-	Pz. Pc.	4	-	1	4	0,33	1,3	-
Esq. interior rinconera Internal mitre	-	Pz. Pc.	4	-	1	4	0,33	1,3	-
Escocia cantonera exterior Round external mitre	-	Pz. Pc.	24	-	1	24	0,1	1,9	-
Escocia rinconera interior Round internal mitre	-	Pz. Pc.	24	-	1	24	0,1	1,9	-

* Unidad de Medida. Los artículos medidos en m² o ml se sirven contando la junta normal entre piezas.
* Unit of Measure. Items measured in sqm or lm are delivered assuming average joint between pieces.

Anchura recomendada de la junta de colocación: Consultar pág. 15.
Recommended joint width: See pg. 15.

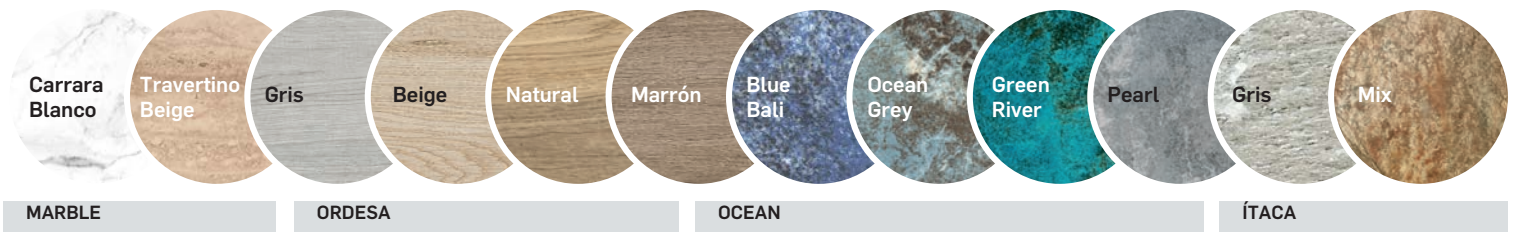

CANTONERA

EXTERNAL RADIAL ANGLE

Antideslizante · Anti slip
[297x42 mm]

Urban Blanco	Cod. 904345	[PZ123]
Urban Gris	Cod. 904346	[PZ123]
Urban Beige	Cod. 904347	[PZ123]
Urban Grafito	Cod. 904790	[PZ123]
Ítaca Gris	Cod. 904388	[PZ123]
Ítaca Mix	Cod. 904387	[PZ123]
Ordesa Gris	Cod. 904674	[PZ123]
Ordesa Beige	Cod. 904675	[PZ123]
Ordesa Natural	Cod. 905531	[PZ123]
Ordesa Marrón	Cod. 904676	[PZ123]
Tibet Blanco	Cod. 905015	[PZ123]
Tibet Gris	Cod. 905016	[PZ123]
Tibet Beige	Cod. 905017	[PZ123]
Tibet Antracita	Cod. 905018	[PZ123]
Ocean Blue Bali	Cod. 905567	[PZ123]
Ocean Coral Bay	Cod. 905170	[PZ123]
Ocean Green River	Cod. 905168	[PZ123]
Ocean Pearl	Cod. 905266	[PZ123]

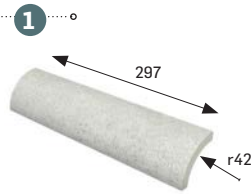

RINCONERA

INTERNAL RADIAL ANGLE

Antideslizante · Anti slip
[297x42 mm]

Urban Blanco	Cod. 904341	[PZ123]
Urban Gris	Cod. 904342	[PZ123]
Urban Beige	Cod. 904343	[PZ123]
Urban Grafito	Cod. 904789	[PZ123]
Ítaca Gris	Cod. 904386	[PZ123]
Ítaca Mix	Cod. 903919	[PZ123]
Ordesa Gris	Cod. 904677	[PZ123]
Ordesa Beige	Cod. 904678	[PZ123]
Ordesa Natural	Cod. 905532	[PZ123]
Ordesa Marrón	Cod. 904679	[PZ123]
Tibet Blanco	Cod. 905011	[PZ123]
Tibet Gris	Cod. 905012	[PZ123]
Tibet Beige	Cod. 905013	[PZ123]
Tibet Antracita	Cod. 905014	[PZ123]
Ocean Blue Bali	Cod. 905568	[PZ123]
Ocean Coral Bay	Cod. 905167	[PZ123]
Ocean Green River	Cod. 905165	[PZ123]
Ocean Pearl	Cod. 905265	[PZ123]



ESQ. EXT. CANTONERA

EXTERNAL MITRE

Antideslizante · Anti slip
[75x75 mm]

Urban Blanco	Cod. 904357	[PZ355]
Urban Gris	Cod. 904358	[PZ355]
Urban Beige	Cod. 904359	[PZ355]
Urban Grafito	Cod. 904794	[PZ355]
Ítaca Gris	Cod. 904394	[PZ355]
Ítaca Mix	Cod. 904393	[PZ355]
Ordesa Gris	Cod. 904686	[PZ355]
Ordesa Beige	Cod. 904687	[PZ355]
Ordesa Natural	Cod. 905533	[PZ355]
Ordesa Marrón	Cod. 904688	[PZ355]
Tibet Blanco	Cod. 905031	[PZ355]
Tibet Gris	Cod. 905032	[PZ355]
Tibet Beige	Cod. 905033	[PZ355]
Tibet Antracita	Cod. 905034	[PZ355]
Ocean Blue Bali	Cod. 905569	[PZ355]
Ocean Coral Bay	Cod. 905182	[PZ355]
Ocean Green River	Cod. 905180	[PZ355]
Ocean Pearl	Cod. 905270	[PZ355]

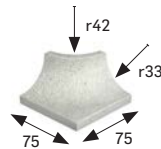

ESQ. INT. RINCONERA

INTERNAL MITRE

Antideslizante · Anti slip
[75x75 mm]

Urban Blanco	Cod. 904361	[PZ355]
Urban Gris	Cod. 904362	[PZ355]
Urban Beige	Cod. 904363	[PZ355]
Urban Grafito	Cod. 904793	[PZ355]
Ítaca Gris	Cod. 904396	[PZ355]
Ítaca Mix	Cod. 904395	[PZ355]
Ordesa Gris	Cod. 904689	[PZ355]
Ordesa Beige	Cod. 904690	[PZ355]
Ordesa Natural	Cod. 905534	[PZ355]
Ordesa Marrón	Cod. 904691	[PZ355]
Tibet Blanco	Cod. 905027	[PZ355]
Tibet Gris	Cod. 905028	[PZ355]
Tibet Beige	Cod. 905029	[PZ355]
Tibet Antracita	Cod. 905030	[PZ355]
Ocean Blue Bali	Cod. 905570	[PZ355]
Ocean Coral Bay	Cod. 905179	[PZ355]
Ocean Green River	Cod. 905177	[PZ355]
Ocean Pearl	Cod. 905269	[PZ355]

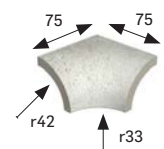

ESCOCIA CANTONERA EXTERIOR

ROUND EXTERNAL MITRE

Antideslizante · Anti slip

Urban Blanco	Cod. 904353	[PZ280]
Urban Gris	Cod. 904354	[PZ280]
Urban Beige	Cod. 904355	[PZ280]
Urban Grafito	Cod. 904792	[PZ280]
Ítaca Gris	Cod. 904392	[PZ280]
Ítaca Mix	Cod. 904391	[PZ280]
Ordesa Gris	Cod. 904680	[PZ280]
Ordesa Beige	Cod. 904681	[PZ280]
Ordesa Natural	Cod. 905535	[PZ280]
Ordesa Marrón	Cod. 904682	[PZ280]
Tibet Blanco	Cod. 905023	[PZ280]
Tibet Gris	Cod. 905024	[PZ280]
Tibet Beige	Cod. 905025	[PZ280]
Tibet Antracita	Cod. 905026	[PZ280]
Ocean Blue Bali	Cod. 905571	[PZ280]
Ocean Coral Bay	Cod. 905176	[PZ280]
Ocean Green River	Cod. 905174	[PZ280]
Ocean Pearl	Cod. 905268	[PZ280]



ESCOCIA RINCONERA INTERIOR

ROUND INTERNAL MITRE

Antideslizante · Anti slip

Urban Blanco	Cod. 904349	[PZ280]
Urban Gris	Cod. 904350	[PZ280]
Urban Beige	Cod. 904351	[PZ280]
Urban Grafito	Cod. 904791	[PZ280]
Ítaca Gris	Cod. 904390	[PZ280]
Ítaca Mix	Cod. 904389	[PZ280]
Ordesa Gris	Cod. 904683	[PZ280]
Ordesa Beige	Cod. 904684	[PZ280]
Ordesa Natural	Cod. 905536	[PZ280]
Ordesa Marrón	Cod. 904685	[PZ280]
Tibet Blanco	Cod. 905019	[PZ280]
Tibet Gris	Cod. 905020	[PZ280]
Tibet Beige	Cod. 905021	[PZ280]
Tibet Antracita	Cod. 905022	[PZ280]
Ocean Blue Bali	Cod. 905572	[PZ280]
Ocean Coral Bay	Cod. 905173	[PZ280]
Ocean Green River	Cod. 905171	[PZ280]
Ocean Pearl	Cod. 905267	[PZ280]

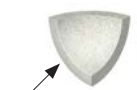

MOSAICOS MOSAICS

Colores / Colors



Blanco
White



Azul pálido
Pale blue



Azul
Blue







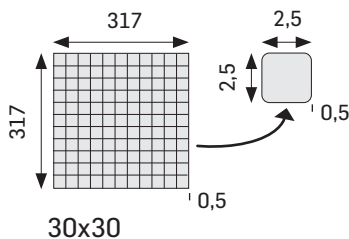









Azul oscuro
Dark blue

(cm) Formatos / Sizes



168

	REVESTIMIENTO WALL TILING	
	PORCELÁNICO PORCELAIN	
	ESMALTADO GLAZED	
	Características dimensionales Dimension tolerance	<0,6% máx 2 mm
	Absorción de agua Water absorption	E≤0,5%
	Coef. Dilatación termica lineal Linear thermal expansion coefficient	5,8x10 ⁻⁶ xC ⁻¹
	Resistencia a la flexión Breaking Strength	>35 N/mm ²
	Resistencia a las manchas Resistance to stains	clase 5 class 5
	Péndulo (CTE) Not required out of Spain	Mates(antislip) 3 Brillantes(glossy) 0
	A pie descalzo Barefoot slip resistance	Mates(antislip) C Brillantes(glossy) A
	A pie calzado Slip resistance with footwear	Mates(antislip) R10 Brillantes(glossy) <R9
	Resistencia al cuarteo Crazing resistance	sí/yes
	Resistencia a la helada Frost resistance	✓
	Resistencia al choque térmico Resistance to thermal shock	✓
	Resistencia química Chemical resistance	✓



Proteger las cajas del agua y la humedad.
El pegamento es hidrosoluble para aumentar la adherencia con el cemento cola durante la colocación.

Protect boxes against water and moisture.
The glue is water-soluble to increase adhesion with adhesive mortars while laying.



MOSAICO BLANCO

Antideslizante · Anti slip Cod. 901899 [MC595]
Brillo · Glossy Cod. 902174 [MC595]

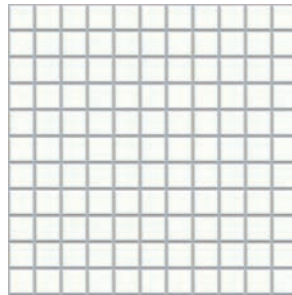

MOSAICO AZUL PÁLIDO

Antideslizante · Anti slip Cod. 902884 [MC595]
Brillo · Glossy Cod. 903735 [MC595]

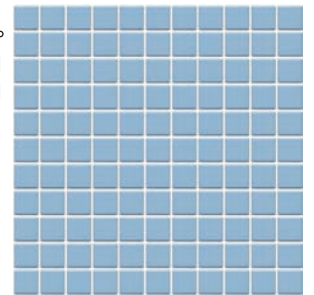

MOSAICO AZUL

Antideslizante · Anti slip Cod. 901898 [MC595]
Brillo · Glossy Cod. 901897 [MC595]

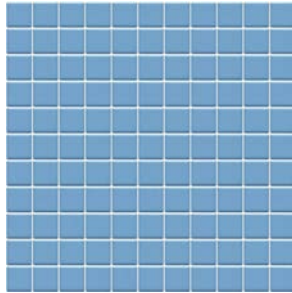

MOSAICO AZUL OSCURO

Antideslizante · Anti slip Cod. 902994 [MC595]
Brillo · Glossy Cod. 903736 [MC595]

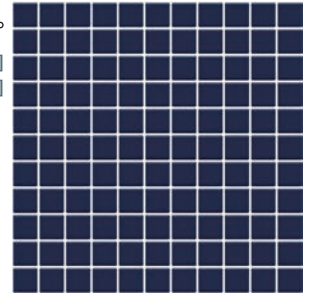

MOSAICO MIX

Antideslizante · Anti slip Cod. 902992 [MC595]
Brillo · Glossy Cod. 903723 [MC595]

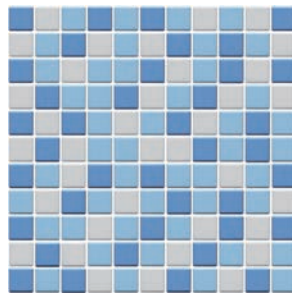

MOSAICO MIX OSCURO

Antideslizante · Anti slip Cod. 902993 [MC595]
Brillo · Glossy Cod. 903722 [MC595]

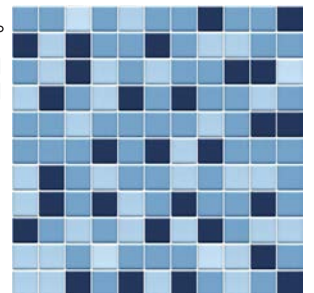

Base 2,5x2,5x0,5	Tile 2,5x2,5x0,5	Espesor (mm) Thickness (mm)	U.M.*	U.M./Caja U.M./Box	U.M./Palet U.M./Pallet	Pzs./U.M. Pcs./U.M.	Pzs./Caja Pcs./Box	Kg./U.M. Kg./U.M.	Kg./Caja Kg./Box	Kg./Palet Kg./Pallet
		5	m ² sqm	1	90	10	10	11,22	11,22	1009,8

PISCINA PÚBLICA RECREATIVA Y PRIVADA PUBLIC RECREATIONAL AND PRIVATE POOL

KLINKER

Colores / Colors	Natural	NATURAL
	Blanco	COTTO
Gris		
COLUMBIA	Beige	
	Aguamarina	
ORION	Beige	
	Gris	
	Jade	
	Antracita	
	Beige	
	Hueso	
	Gris	
	Carbón	
	Rojo	
	Chocolate	CAPRI

(cm) Formatos / Sizes

















12x25

20x20

25x25

33x33

33x50

	Natural Cotto	Columbia Orión Capri
 NATURAL	NATURAL UNGLAZED	
 ESMALTADO		ESMALTADO GLAZED
 Características dimensionales Dimension tolerance	<1,25% máx 2 mm	<1,25% máx 2 mm
 Absorción de agua Water absorption	3<E≤6%	3<E≤6%
 Coef. Dilatación termica lineal Linear thermal expansion coefficient	3,8x10 ⁻⁶ xC ⁻¹	3,8x10 ⁻⁶ xC ⁻¹
 Resistencia a la flexión Breaking Strength	20 a 25 N/ mm ²	20 N/mm ²
 Resistencia a la abrasión profunda Resistance to deep abrasion	<393mm ²	
 Resistencia a la abrasión superficial Resistance to surface abrasion		PEI 2 a/to 4 según color/ depending on color
 Desgaste transito peatonal Erosion to pedestrian transit		H4
 Resistencia a las manchas Resistance to stains	clase 3 a 5 class 3 to 5	clase 5 class 5
 Péndulo (CTE) Not required out of Spain	clase 3 class 3	clase 2 class 2
 A pie descalzo Barefoot slip resistance	C	Capri, Columbia B Orion C
 A pie calzado Slip resistance with footwear	R11	Capri, Columbia R10 Orion R11
 Resistencia al cuarteo Crazing resistance		sí/yes
 Resistencia a la helada Frost resistance	✓	✓
 Resistencia al choque térmico Resistance to thermal shock	✓	✓
 Resistencia química Chemical resistance	✓	✓

170

PISCINA PÚBLICA RECREATIVA Y PRIVADA PUBLIC RECREATIONAL AND PRIVATE POOL



Natural 33x33



BASES

KLINKER



BASE 12x25 TILE 12x25

[119x244x14 mm]

Natural Cod. 900013 [MC415]
Cotto Blanco Cod. 901587 [MC410]
Cotto Gris Cod. 901589 [MC410]

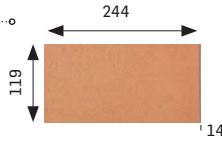

BASE 20x20 TILE 20x20

[195x195x14 mm]

Natural Cod. 900181 [MC400]

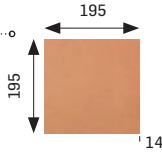

BASE 25x25 TILE 25x25

[244x244x14 mm]

Natural Cod. 900005 [MC390]
Cotto Blanco Cod. 902675 [MC410]
Cotto Gris Cod. 902799 [MC410]

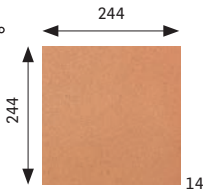

BASE 33x33 TILE 33x33

[325x325x16 mm]

Natural Cod. 901001 [MC440]
Cotto Blanco Cod. 902683 [MC470]
Cotto Gris Cod. 902800 [MC470]
Columbia Beige Cod. 901656 [MC510]
Columbia Aguamarina Cod. 901657 [MC510]
Orión Beige Cod. 903969 [MC510]
Orión Gris Cod. 904189 [MC510]
Orión Jade Cod. 903976 [MC510]
Orión Antracita Cod. 904602 [MC510]
Capri Beige Cod. 905076 [MC510]
Capri Hueso Cod. 905077 [MC510]
Capri Gris Cod. 905078 [MC510]
Capri Carbón Cod. 905079 [MC510]
Capri Rojo Cod. 905650 [MC510]
Capri Chocolate Cod. 905143 [MC510]

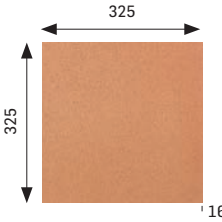

BASE 33x50 TILE 33x50

[325x492x16 mm]

Orión Beige Cod. 904476 [MC555]
Orión Gris Cod. 904472 [MC555]
Orión Jade Cod. 904475 [MC555]
Orión Antracita Cod. 904603 [MC555]
Capri Beige Cod. 905080 [MC555]
Capri Hueso Cod. 905081 [MC555]
Capri Gris Cod. 905082 [MC555]
Capri Carbón Cod. 905083 [MC555]
Capri Rojo Cod. 905651 [MC555]
Capri Chocolate Cod. 905144 [MC555]

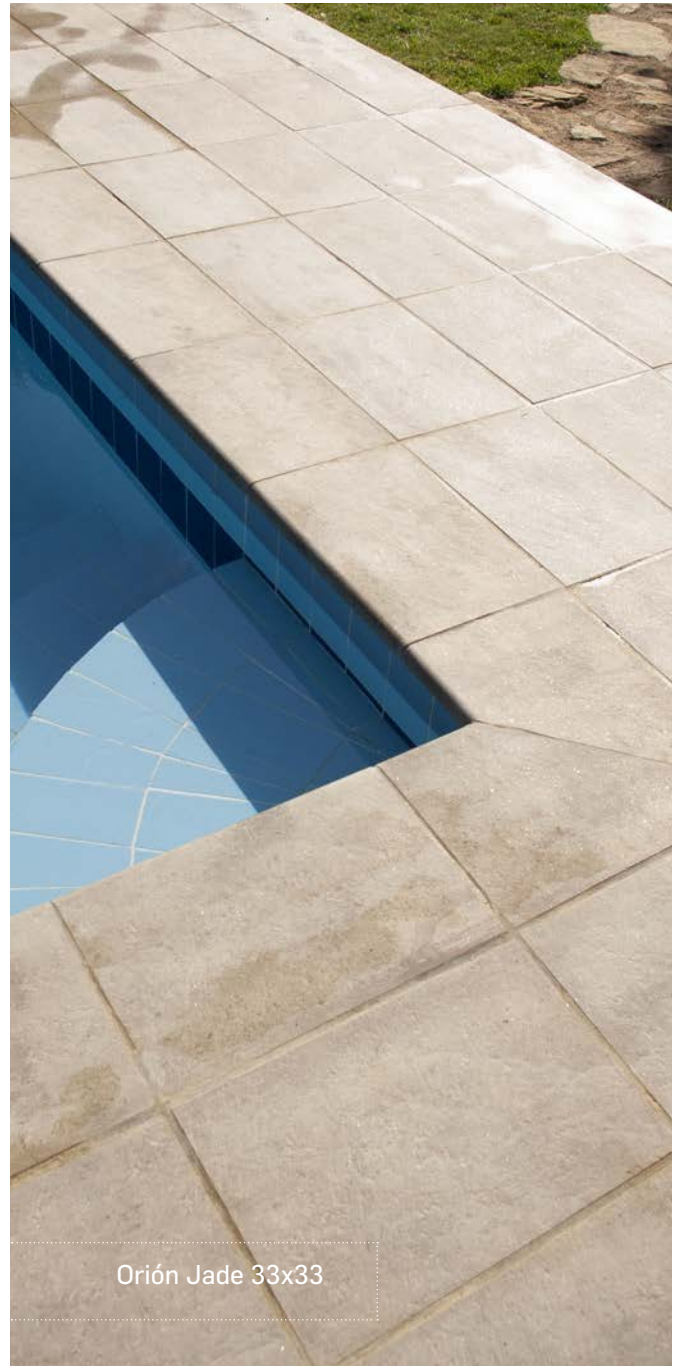

172

PISCINA PÚBLICA RECREATIVA Y PRIVADA PUBLIC RECREATIONAL AND PRIVATE POOL

	Espesor (mm) Thickness (mm)	U.M.*	U.M./Caja U.M./Box	U.M./Palet U.M./Pallet	Pzs./U.M. Pcs./U.M.	Pzs./Caja Pcs./Box	Kg./U.M. Kg./U.M.	Kg./Caja Kg./Box	Kg./Palet Kg./Pallet
Base 12x25 Tile 12x25	14	m ² sqm	0,5	60	32	16	24,80	12,40	1489
Base 20x20 Tile 20x20	14	m ² sqm	0,84	50,4	25	21	24,2	20,32	1219
Base 25x25 Tile 25x25	14	m ² sqm	1	60	16	16	26	26	1560
Base 33x33 Tile 33x33	16	m ² sqm	0,666	42,624	9	6	32,6	21,75	1391
Base 33x50 Tile 33x50	16	m ² sqm	0,66	42,624	6	4	32,6	20,83	1348

* Unidad de Medida. Los artículos medidos en m² o ml se sirven contando la junta normal entre piezas.
 * Unit of Measure. Items measured in sqm or lm are delivered assuming average joint between pieces.

Anchura recomendada de la junta de colocación: 6-8 mm.
 Recommended joint width 6-8 mm

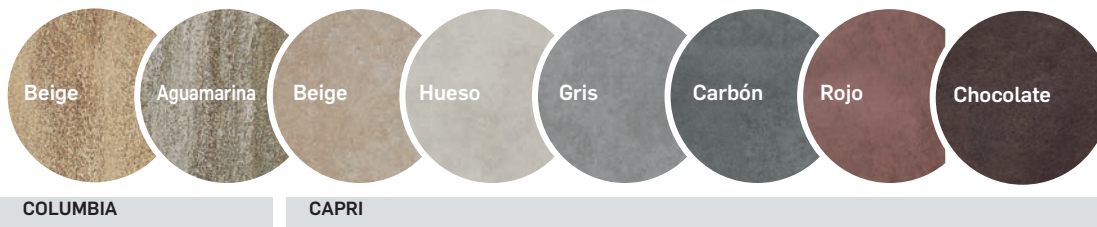

PIEZAS ESPECIALES SPECIAL PIECES KLINKER

PELDAÑO RECTO 50

STRAIGHT STAIR-TREAD 50
[297x315x14 mm]

Orión Beige	Cod. 904493	[PZ355]
Orión Gris	Cod. 904482	[PZ355]
Orión Jade	Cod. 904489	[PZ355]
Orión Antracita	Cod. 904608	[PZ355]
Capri Beige	Cod. 905092	[PZ355]
Capri Hueso	Cod. 905093	[PZ355]
Capri Gris	Cod. 905094	[PZ355]
Capri Carbón	Cod. 905095	[PZ355]
Capri Rojo	Cod. 905654	[PZ355]
Capri Chocolate	Cod. 905147	[PZ355]

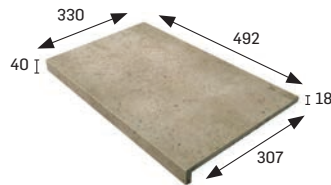

REJILLA CERÁMICA MONOCOMPACT

MONOCOMPACT CERAMIC GRID **
[297x315x14 mm]

Natural	Cod. 902972	[PZ645]
Cotto Blanco	Cod. 902973	[PZ645]
Cotto Gris	Cod. 902974	[PZ645]
Columbia Beige	Cod. 902976	[PZ645]
Columbia Aguamarina	Cod. 902977	[PZ645]
Orión Beige	Cod. 904494	[PZ645]
Orión Gris	Cod. 904486	[PZ645]
Orión Jade	Cod. 904490	[PZ645]
Orión Antracita	Cod. 904613	[PZ645]

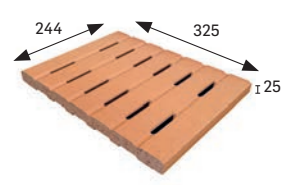

** En rejillas los agujeros siempre deben ir perpendiculares al vaso para una mayor resistencia, con canal de 250 mm de ancho.
** Install the grids with the holes always perpendicular to the pool vessel to get a greater resistance, with a channel 250 mm wide.

ESQUINA REJILLA

CORNER GRID
[293x244x25x80 mm]

Natural	Cod. 901489	[JG750]
Cotto Blanco	Cod. 901490	[JG750]
Cotto Gris	Cod. 901491	[JG750]
Columbia Beige	Cod. 901494	[JG750]
Columbia Aguamarina	Cod. 901493	[JG750]
Orión Beige	Cod. 904495	[JG750]
Orión Gris	Cod. 904487	[JG750]
Orión Jade	Cod. 904491	[JG750]
Orión Antracita	Cod. 904614	[JG750]

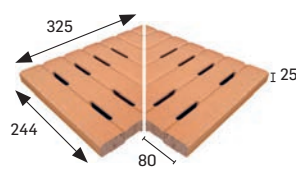

CANALETA*

OVERFLOW CHANNEL
[325x325x30 mm]

Natural	Cod. 901871	[PZ250]
Cotto Blanco	Cod. 901869	[PZ250]
Cotto Gris	Cod. 901889	[PZ250]
Columbia Beige	Cod. 901894	[PZ250]
Columbia Aguamarina	Cod. 901895	[PZ250]

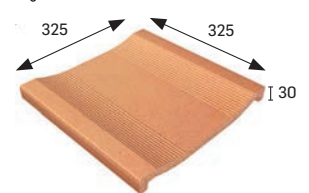

* Disponible Canaleta con desagüe.
* Overflow channel with drainage available.



Columbia Aguamarina 33x33

	Espesor (mm) Thickness (mm)	U.M.*	U.M./Caja U.M./Box	U.M./Palet U.M./Pallet	Pzs./U.M. Pcs./U.M.	Pzs./Caja Pcs./Box	Kg./U.M. Kg./U.M.	Kg./Caja Kg./Box	Kg./Palet Kg./Pallet
Peldaño recto 50 Straight stair-tread 50	18	Pz. Pc.	4	144	1	4	6,33	25,3	911
Rejilla cerámica monocompact Monocompact ceramic grid	25	Pz. Pc.	6	378	1	6	3,58	21,5	-
Esquina rejilla Corner grid	25	Set Set	3	-	2	6	4,69	14,07	-
Canaleta Overflow channel	30	Pz. Pc.	3	99	1	3	4,43	13,3	438,6

* Unidad de Medida. Los artículos medidos en m² o ml se sirven contando la junta normal entre piezas.
* Unit of Measure. Items measured in sqm or lm are delivered assuming average joint between pieces.

PISCINA DEPORTIVA SPORTS POOLS



174

PISCINA DEPORTIVA SPORTS POOL

(cm) Formatos / Sizes

12x25

25x25

25x50

	Bases antideslizantes Ranurados Celdillas	Revestimientos
		REVESTIMIENTO WALL TILING
	PORCELÁNICO PORCELAIN	PORCELÁNICO PORCELAIN
	ESMALTADO GLAZED	ESMALTADO GLAZED
	Características dimensionales Dimension tolerance	<1% / <0,6% máx 2 mm
	Absorción de agua Water absorption	E≤0,5%
	Coef. Dilatación termica lineal Linear thermal expansion coefficient	5,8x10 ⁻⁶ xC ⁻¹
	Resistencia a la flexión Breaking Strength	>43 N/mm ²
	Resistencia al rayado (Método Mohs) Scratch hardness of surface (Mohs Method)	6 a 8
	Resistencia a las manchas Resistance to stains	clase 5 class 5
	Péndulo (CTE) Not required out of Spain	clase 3 class 3
	A pie descalzo Barefoot slip resistance	C
	A pie calzado Slip resistance with footwear	Liso R10 Ranurado R11 Celdillas R12
	Resistencia al cuarteo Crazing resistance	sí/yes
	Coefficiente fricción dinámico (DCOF) Dynamic coefficient of friction	>0,82
	Resistencia a la helada Frost resistance	✓
	Resistencia al choque térmico Resistance to thermal shock	✓
	Resistencia química Chemical resistance	✓
	Antibacteriano Antibacterian	Aciker natural / Aciker Gris / Blanco Natural Aciker / Grey Aciker / White R>2 Reducción antibacteriana >99 %



BASES



Bases antideslizantes Anti slip tiles
Aciker Natural / Natural Aciker
Blanco / White
Aciker Gris / Grey Aciker

BASES ANTIDESLIZANTES ANTI SLIP TILES

REVESTIMIENTOS WALL TILES

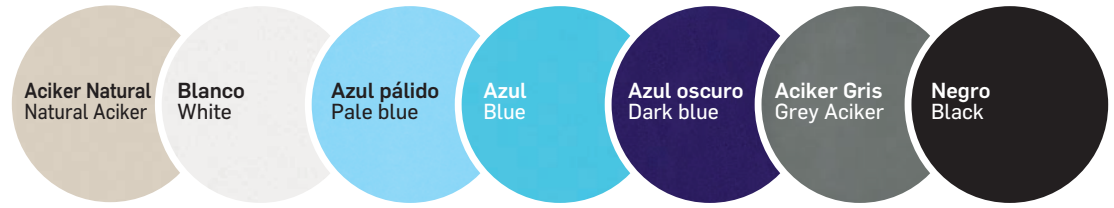

BASE 12x25 TILE 12x25

[119x244x8 mm]

Bases antideslizantes Anti slip tiles
 Mate / Matt

Aciker Natural / Natural Aciker	Cod. 904021	[MC420]
Blanco / White	Cod. 904010	[MC420]
Azul pálido / Pale blue	Cod. 904009	[MC420]
Azul / Blue	Cod. 904004	[MC420]
Azul oscuro / Dark blue	Cod. 904006	[MC437]
Aciker Gris / Grey Aciker	Cod. 904000	[MC505]
Negro / Black	Cod. 904023	[MC437]

Revestimientos Wall tiles
 Brillo / Glossy

Aciker Natural / Natural Aciker	Cod. 904002	[MC405]
Blanco / White	Cod. 904011	[MC410]
Azul pálido / Pale blue	Cod. 904008	[MC410]
Azul / Blue	Cod. 904005	[MC410]
Azul oscuro / Dark blue	Cod. 904007	[MC437]
Aciker Gris / Grey Aciker	Cod. 904001	[MC437]
Negro / Black	Cod. 904022	[MC437]

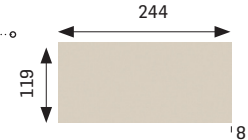

BASE 25x50 TILE 25x50

[244x494x8,5 mm]

Bases antideslizantes Anti slip tiles
 Mate / Matt

Aciker Natural / Natural Aciker	Cod. 904501	[MC453]
Blanco / White	Cod. 904497	[MC453]
Azul pálido / Pale blue	Cod. 904500	[MC453]
Azul / Blue	Cod. 904496	[MC453]
Azul oscuro / Dark blue	Cod. 904498	[MC501]
Aciker Gris / Grey Aciker	Cod. 904502	[MC501]
Negro / Black	Cod. 904499	[MC501]

Revestimientos Wall tiles
 Brillo / Glossy

Aciker Natural / Natural Aciker	Cod. 904508	[MC437]
Blanco / White	Cod. 904504	[MC437]
Azul pálido / Pale blue	Cod. 904507	[MC437]
Azul / Blue	Cod. 904503	[MC437]
Azul oscuro / Dark blue	Cod. 904505	[MC501]
Aciker Gris / Grey Aciker	Cod. 904509	[MC437]
Negro / Black	Cod. 904506	[MC501]

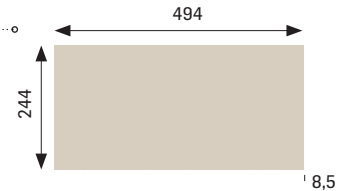

RANURADOS GROOVED TILES



BASE 12x25 TILE 12x25

[119x244x8 mm]

Bases antideslizantes - Mate / Anti slip tiles - Matt

Aciker Natural / Natural Aciker	Cod. 905545	[MC560]
Blanco / White	Cod. 905358	[MC560]
Azul pálido / Pale blue	Cod. 905640	[MC560]
Azul / Blue	Cod. 905469	[MC560]
Azul oscuro / Dark blue	Cod. 905471	[MC583]
Aciker Gris / Grey Aciker	Cod. 905350	[MC583]
Negro / Black	Cod. 905641	[MC583]

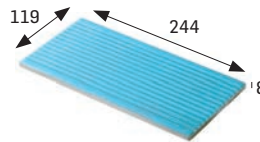

	Espeor (mm) Thickness (mm)	U.M.*	U.M./Caja U.M./Box	U.M./Palet U.M./Pallet	Pzs./U.M. Pcs./U.M.	Pzs./Caja Pcs./Box	Kg./U.M. Kg./U.M.	Kg./Caja Kg./Box	Kg./Palet Kg./Pallet
Base 12x25 Tile 12x25	8	m ² sqm	1,06	85	32	34	16,68	17,68	1408
Base 25x50 Tile 25x50	8,5	m ² sqm	1	56	8	8	19	19,3	1080
Ranurado Grooved	8	m ² sqm	1,06	85	32	34	16,68	17,68	1408

* Unidad de Medida. Los artículos medidos en m² o ml se sirven contando la junta normal entre piezas.
 * Unit of Measure. Items measured in sqm or lm are delivered assuming average joint between pieces.

CELDILLAS
CELL TEXTURES

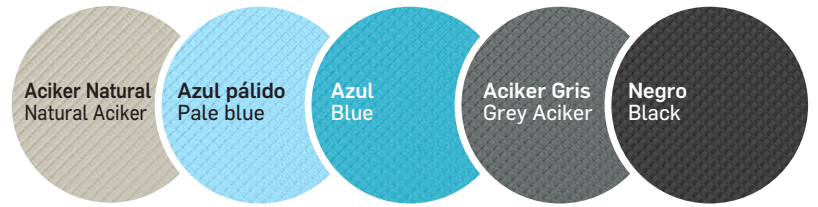

BASE 12x25 TILE 12x25

[119x244x8 mm]

Bases antideslizantes - Mate / Anti slip tiles - Matt

- Aciker Natural / Natural Aciker** Cod. 905346 [MC493]
- Azul pálido / Pale blue** Cod. 905357 [MC553]
- Aciker Gris / Grey Aciker** Cod. 905348 [MC553]
- Negro / Black** Cod. 905772 [MC553]

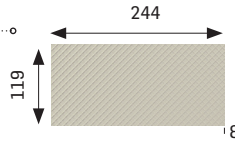

BASE 25x25 TILE 25x25

[244x244x8 mm]

Bases antideslizantes - Mate / Anti slip tiles - Matt

- Aciker Natural / Natural Aciker** Cod. 905336 [MC501]
- Azul pálido / Pale blue** Cod. 905769 [MC553]
- Azul / Blue** Cod. 905770 [MC553]
- Aciker Gris / Grey Aciker** Cod. 905338 [MC553]
- Negro / Black** Cod. 905771 [MC630]

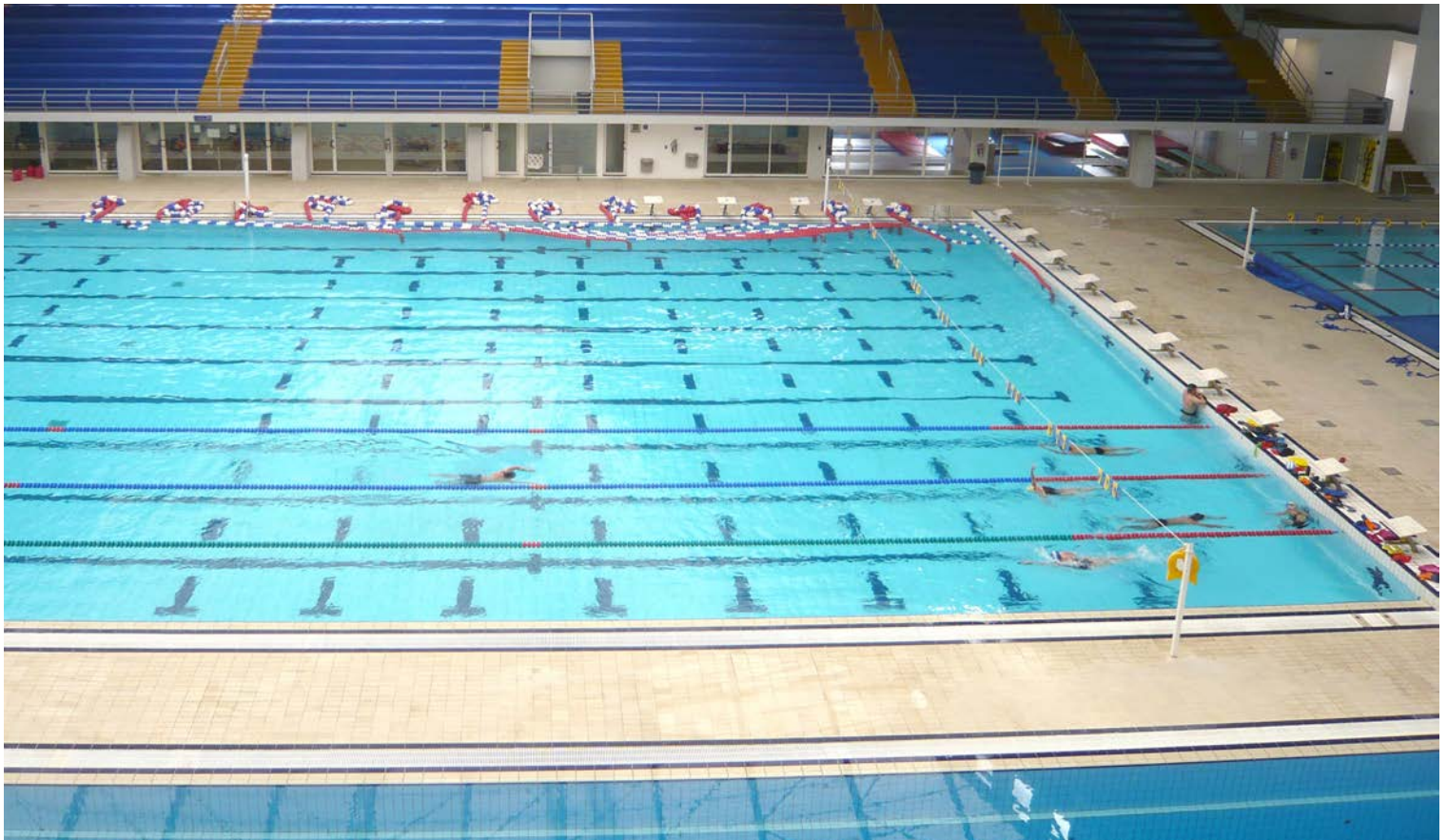
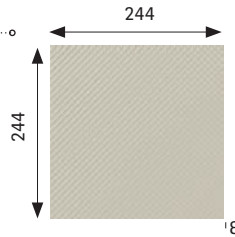

	Espe­sor (mm) Thick­ness (mm)	U.M.*	U.M./Caja U.M./Box	U.M./Palet U.M./Pallet	Pzs./U.M. Pcs./U.M.	Pzs./Caja Pcs./Box	Kg./U.M. Kg./U.M.	Kg./Caja Kg./Box	Kg./Palet Kg./Pallet
Celdillas 12x25 Cells 12x25	8	m ² sqm	1,06	85	32	34	16,68	17,68	1408
Celdillas 25x25 Cells 25x25	8	m ² sqm	0,56	67,5	16	9	17,6	9,85	1182,6

* Unidad de Medida. Los artículos medidos en m² o ml se sirven contando la junta normal entre piezas.
* Unit of Measure. Items measured in sqm or lm are delivered assuming average joint between pieces.

PIEZAS ESPECIALES SPECIAL PIECES

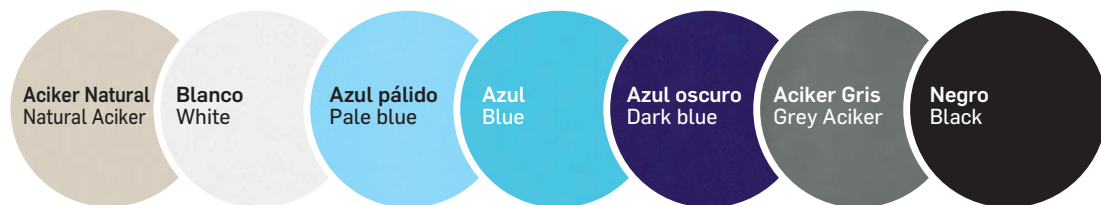

Bases antideslizantes Anti slip tiles
Aciker Natural / Natural Aciker
Blanco / White
Aciker Gris / Grey Aciker

RINCONERA

INTERNAL RADIAL ANGLE
[244x42 mm]

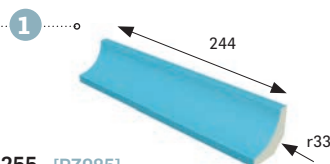

Antideslizante - Mate / Anti slip - Matt

Aciker Natural / Natural Aciker	Cod. 903255	[PZ085]
Blanco / White	Cod. 905603	[PZ085]
Azul pálido / Pale blue	Cod. 905604	[PZ085]
Azul / Blue	Cod. 905605	[PZ085]
Azul oscuro / Dark blue	Cod. 905547	[PZ085]
Aciker Gris / Grey Aciker	Cod. 903632	[PZ085]
Negro / Black	Cod. 905546	[PZ085]

Revestimientos - Brillo / Wall tiles - Glossy

Aciker Natural / Natural Aciker	Cod. 905597	[PZ085]
Blanco / White	Cod. 902331	[PZ085]
Azul pálido / Pale blue	Cod. 905598	[PZ085]
Azul / Blue	Cod. 905599	[PZ085]
Azul oscuro / Dark blue	Cod. 905600	[PZ085]
Aciker Gris / Grey Aciker	Cod. 905601	[PZ085]
Negro / Black	Cod. 905602	[PZ085]

CANTONERA

EXTERNAL RADIAL ANGLE
[244x42 mm]



Antideslizante - Mate / Anti slip - Matt

Aciker Natural / Natural Aciker	Cod. 903256	[PZ085]
Blanco / White	Cod. 905494	[PZ085]
Azul pálido / Pale blue	Cod. 905576	[PZ085]
Azul / Blue	Cod. 905577	[PZ085]
Azul oscuro / Dark blue	Cod. 905578	[PZ085]
Aciker Gris / Grey Aciker	Cod. 903631	[PZ085]
Negro / Black	Cod. 905579	[PZ085]

Revestimientos - Brillo / Wall tiles - Glossy

Aciker Natural / Natural Aciker	Cod. 905580	[PZ085]
Blanco / White	Cod. 905581	[PZ085]
Azul pálido / Pale blue	Cod. 905582	[PZ085]
Azul / Blue	Cod. 905583	[PZ085]
Azul oscuro / Dark blue	Cod. 905584	[PZ085]
Aciker Gris / Grey Aciker	Cod. 905585	[PZ085]
Negro / Black	Cod. 905586	[PZ085]

ESQUINA INTERIOR RINCONERA

INTERNAL MITRE
[75x75 mm]

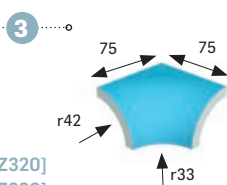

Antideslizante - Mate / Anti slip - Matt

Aciker Natural / Natural Aciker	Cod. 905725	[PZ320]
Blanco / White	Cod. 905726	[PZ320]
Azul pálido / Pale blue	Cod. 905727	[PZ335]
Azul / Blue	Cod. 905728	[PZ320]
Azul oscuro / Dark blue	Cod. 905729	[PZ335]
Aciker Gris / Grey Aciker	Cod. 905730	[PZ335]
Negro / Black	Cod. 905732	[PZ335]

Revestimientos - Brillo / Wall tiles - Glossy

Aciker Natural / Natural Aciker	Cod. 905733	[PZ270]
Blanco / White	Cod. 905734	[PZ320]
Azul pálido / Pale blue	Cod. 905735	[PZ345]
Azul / Blue	Cod. 905736	[PZ320]
Azul oscuro / Dark blue	Cod. 905737	[PZ345]
Aciker Gris / Grey Aciker	Cod. 905738	[PZ345]
Negro / Black	Cod. 905739	[PZ345]

ESQUINA EXTERIOR CANTONERA

EXTERNAL MITRE
[75x75 mm]

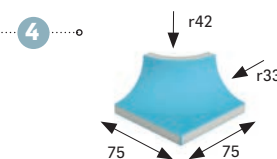

Antideslizante - Mate / Anti slip - Matt

Aciker Natural / Natural Aciker	Cod. 905740	[PZ320]
Blanco / White	Cod. 905741	[PZ320]
Azul pálido / Pale blue	Cod. 905742	[PZ335]
Azul / Blue	Cod. 905743	[PZ320]
Azul oscuro / Dark blue	Cod. 905744	[PZ335]
Aciker Gris / Grey Aciker	Cod. 905745	[PZ335]
Negro / Black	Cod. 905747	[PZ335]

Revestimientos - Brillo / Wall tiles - Glossy

Aciker Natural / Natural Aciker	Cod. 905748	[PZ270]
Blanco / White	Cod. 905749	[PZ320]
Azul pálido / Pale blue	Cod. 905750	[PZ345]
Azul / Blue	Cod. 905751	[PZ320]
Azul oscuro / Dark blue	Cod. 905752	[PZ345]
Aciker Gris / Grey Aciker	Cod. 905753	[PZ345]
Negro / Black	Cod. 905754	[PZ345]

	Espesor (mm) Thickness (mm)	U.M.*	U.M./Caja U.M./Box	U.M./Palet U.M./Pallet	Pzs./U.M. Pcs./U.M.	Pzs./Caja Pcs./Box	Kg./U.M. Kg./U.M.	Kg./Caja Kg./Box	Kg./Palet Kg./Pallet
Rinconera Internal radial angle	-	Pz. Pc.	35	1260	1	35	0,41	14,2	511
Cantonera External radial angle	-	Pz. Pc.	42	1512	1	42	0,34	14,5	522
Esq. int. rinconera Internal mitre	-	Pz. Pc.	4	-	1	4	0,33	1,3	-
Esq. ext. cantonera External mitre	-	Pz. Pc.	4	-	1	4	0,33	1,3	-
Escocia rinconera interior Round internal mitre	-	Pz. Pc.	24	-	1	24	0,1	1,9	-
Escocia cantonera exterior Round external mitre	-	Pz. Pc.	24	-	1	24	0,1	1,9	-
Canto romo Bullnose	9,5	Pz. Pc.	27	2160	1	20	0,65	17,55	1404
Piezas señalización Marking tiles	8	Set Set	16	-	2	32	1,07	17,23	-

* Unidad de Medida. Los artículos medidos en m² o ml se sirven contando la junta normal entre piezas.
 * Unit of Measure. Items measured in sqm or lm are delivered assuming average joint between pieces.

Anchura recomendada de la junta de colocación: 6 mm
 Recommended joint width: 6 mm

ESCOCIA RINCONERA INTERIOR

ROUND INTERNAL MITRE

5

Antideslizante - Mate / Anti slip - Matt

Aciker Natural / Natural Aciker	Cod. 905606	[PZ270]
Blanco / White	Cod. 905607	[PZ270]
Azul pálido / Pale blue	Cod. 905608	[PZ270]
Azul / Blue	Cod. 905609	[PZ270]
Azul oscuro / Dark blue	Cod. 905610	[PZ270]
Aciker Gris / Grey Aciker	Cod. 905611	[PZ270]
Negro / Black	Cod. 905612	[PZ270]

Revestimientos - Brillo / Wall tiles - Glossy

Aciker Natural / Natural Aciker	Cod. 905613	[PZ270]
Blanco / White	Cod. 905614	[PZ270]
Azul pálido / Pale blue	Cod. 905615	[PZ270]
Azul / Blue	Cod. 905616	[PZ270]
Azul oscuro / Dark blue	Cod. 905617	[PZ270]
Aciker Gris / Grey Aciker	Cod. 905618	[PZ270]
Negro / Black	Cod. 905619	[PZ270]

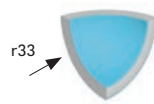

ESCOCIA CANTONERA EXTERIOR

ROUND EXTERNAL MITRE

6

Antideslizante - Mate / Anti slip - Matt

Aciker Natural / Natural Aciker	Cod. 905620	[PZ270]
Blanco / White	Cod. 905621	[PZ270]
Azul pálido / Pale blue	Cod. 905622	[PZ270]
Azul / Blue	Cod. 905623	[PZ270]
Azul oscuro / Dark blue	Cod. 905624	[PZ270]
Aciker Gris / Grey Aciker	Cod. 905625	[PZ270]
Negro / Black	Cod. 905626	[PZ270]

Revestimientos - Brillo / Wall tiles - Glossy

Aciker Natural / Natural Aciker	Cod. 905627	[PZ270]
Blanco / White	Cod. 905628	[PZ270]
Azul pálido / Pale blue	Cod. 905629	[PZ270]
Azul / Blue	Cod. 905630	[PZ270]
Azul oscuro / Dark blue	Cod. 905631	[PZ270]
Aciker Gris / Grey Aciker	Cod. 905632	[PZ270]
Negro / Black	Cod. 905633	[PZ270]

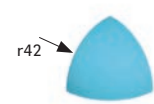

CANTO ROMO

BULLNOSE

[244x119x9,5 mm]

7

Antideslizante - Mate / Anti slip - Matt

Aciker Natural / Natural Aciker	Cod. 900687	[PZ123]
Blanco / White	Cod. 903119	[PZ123]
Azul pálido / Pale blue	Cod. 903780	[PZ123]
Azul / Blue	Cod. 903113	[PZ123]
Azul oscuro / Dark blue	Cod. 903118	[PZ123]
Aciker Gris / Grey Aciker	Cod. 901711	[PZ123]
Negro / Black	Cod. 903779	[PZ123]

Revestimientos - Brillo / Wall tiles - Glossy

Aciker Natural / Natural Aciker	Cod. 903839	[PZ123]
Blanco / White	Cod. 901267	[PZ123]
Azul pálido / Pale blue	Cod. 903484	[PZ123]
Azul / Blue	Cod. 901266	[PZ123]
Azul oscuro / Dark blue	Cod. 904099	[PZ123]
Aciker Gris / Grey Aciker	Cod. 903752	[PZ123]
Negro / Black	Cod. 903753	[PZ123]

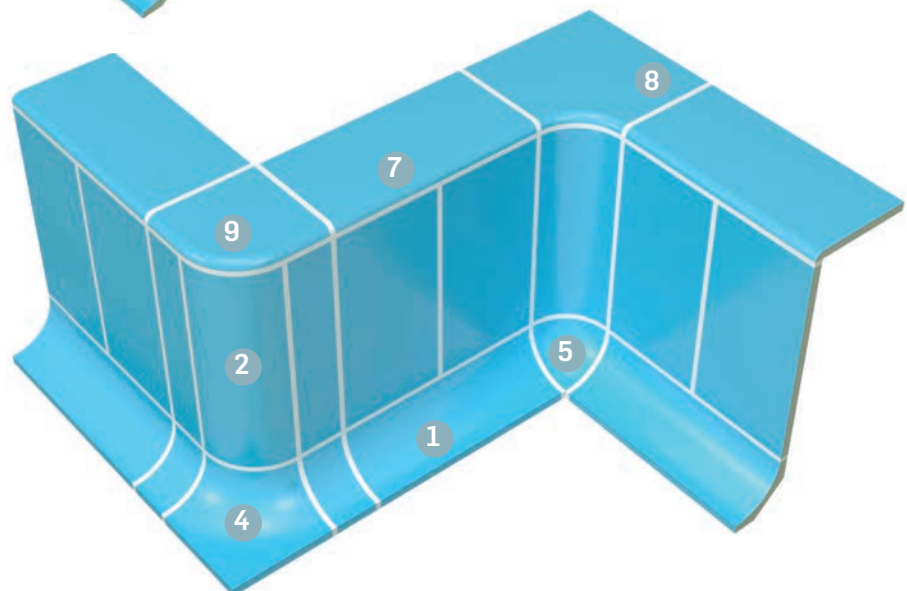
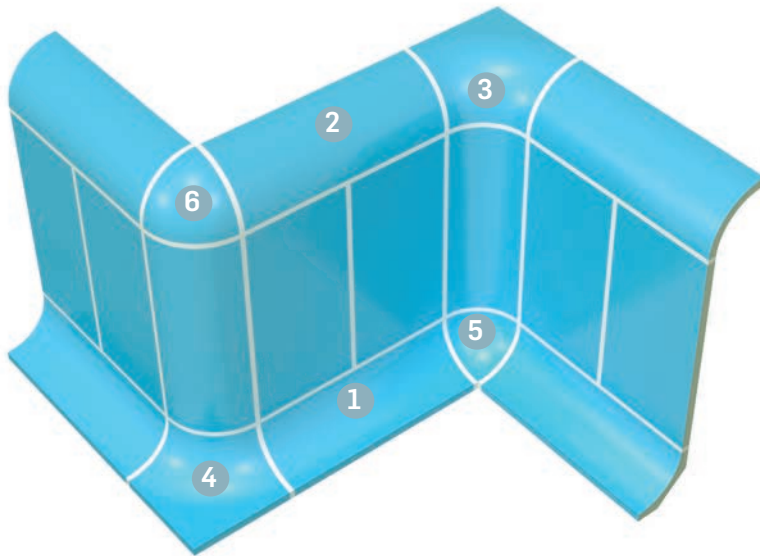
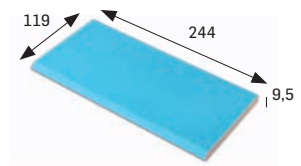

PIEZAS ESPECIALES SPECIAL PIECES

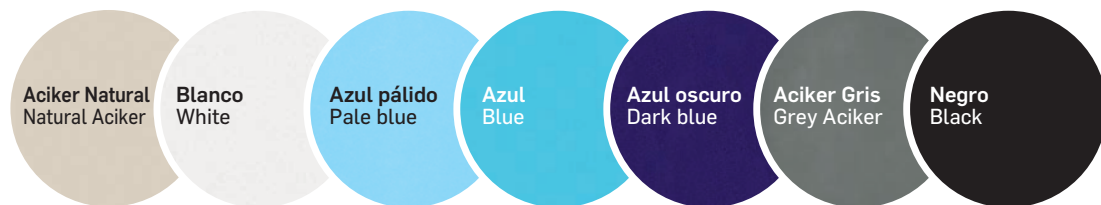

Bases antideslizantes Anti slip tiles
Aciker Natural / Natural Aciker
Blanco / White
Aciker Gris / Grey Aciker

ESQ. INT. CANTO ROMO

BULLNOSE INT. CORNER
 [168x168x9,5 mm]

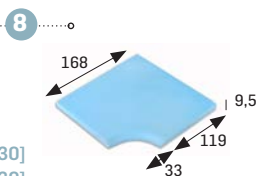

Antideslizante - Mate / Anti slip - Matt

Aciker Natural / Natural Aciker Cod. 905755 [PZ330]
Blanco / White Cod. 905756 [PZ330]
Azul pálido / Pale blue Cod. 905757 [PZ330]
Azul / Blue Cod. 905758 [PZ330]
Azul oscuro / Dark blue Cod. 905759 [PZ330]
Aciker Gris / Grey Aciker Cod. 905760 [PZ350]
Negro / Black Cod. 905761 [PZ350]

ESQ. EXT. CANTO ROMO

BULLNOSE EXTERNAL CORNER
 [119x119x9,5 mm]

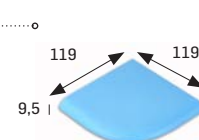

Antideslizante - Mate / Anti slip - Matt

Aciker Natural / Natural Aciker Cod. 905762 [PZ330]
Blanco / White Cod. 905763 [PZ330]
Azul pálido / Pale blue Cod. 905764 [PZ330]
Azul / Blue Cod. 905765 [PZ330]
Azul oscuro / Dark blue Cod. 905766 [PZ330]
Aciker Gris / Grey Aciker Cod. 905767 [PZ350]
Negro / Black Cod. 905768 [PZ350]

CANTO ROMO RANURADO

GROOVED BULLNOSE
 [244x119x9,5 mm]

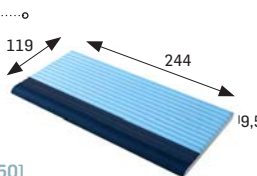

Antideslizante - Mate / Anti slip - Matt

Azul / Azul oscuro **
 Blue / Dark blue Cod. 905662 [PZ150]
Natural / Azul oscuro **
 Natural / Dark blue Cod. 905666 [PZ150]

**Disponibles otras combinaciones de color bajo pedido.
 **Other color combinations available on demand.

APOYO REJILLA

GRID SUPPORT
 [244x145x31 mm]

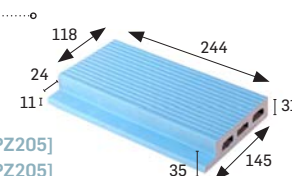

Antideslizante - Mate / Anti slip - Matt

Aciker Natural / Natural Aciker Cod. 905667 [PZ205]
Blanco / White Cod. 905668 [PZ205]
Azul / Blue Cod. 905669 [PZ205]
Azul oscuro / Dark blue Cod. 905670 [PZ205]

CANAL

CHANNEL
 [244x150x30 mm]

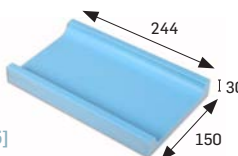

Antideslizante - Mate / Anti slip - Matt

Azul / Blue Cod. 903176 [PZ285]

CANAL CON DESAGÜE

DUCT
 [244x150x30 mm]

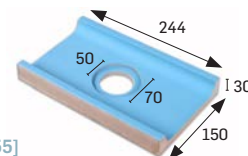

Antideslizante - Mate / Anti slip - Matt

Azul / Blue Cod. 903177 [PZ355]

CANALETA

OVERFLOW CHANNEL
 [244x150x28 mm]

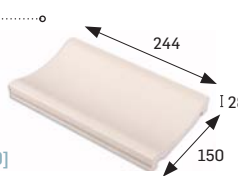

Antideslizante - Mate / Anti slip - Matt

Aciker Natural / Natural Aciker Cod. 900659 [PZ290]

CANALETA CON DESAGÜE

DRAINAGE OVERFLOW CHANNEL
 [244x150x28 mm]

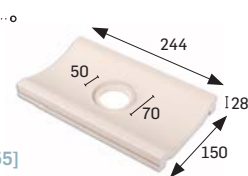

Antideslizante - Mate / Anti slip - Matt

Aciker Natural / Natural Aciker Cod. 900660 [PZ355]

	Espesor (mm) Thickness (mm)	U.M.*	U.M./Caja U.M./Box	U.M./Palet U.M./Pallet	Pzs./U.M. Pcs./U.M.	Pzs./Caja Pcs./Box	Kg./U.M. Kg./U.M.	Kg./Caja Kg./Box	Kg./Palet Kg./Pallet
Esq. int. canto romo Bullnose int. corner	9,5	Pz. Pc.	4	-	1	4	0,48	1,9	-
Esq. ext. canto romo Bullnose ext. corner	9,5	Pz. Pc.	4	-	1	4	0,25	1	-
Canto romo ranurado Grooved bullnose	9,5	Pz. Pc.	27	1944	1	27	0,57	15,39	1108
Apoyo rejilla Grid support	31	Pz. Pc.	8	512	1	8	1,79	14,32	916
Canal Channel	30	Pz. Pc.	9	576	1	9	1,24	11,2	714
Canal desagüe Duct	30	Pz. Pc.	9	-	1	9	1,24	11,2	-
Canaleta Overflow channel	28	Pz. Pc.	11	704	1	11	1,3	14,5	930
Canaleta desagüe Drainage overflow channel	28	Pz. Pc.	11	-	1	11	1,3	14,5	-

* Unidad de Medida. Los artículos medidos en m² o ml se sirven contando la junta normal entre piezas.
 * Unit of Measure. Items measured in sqm or lm are delivered assuming average joint between pieces.

Anchura recomendada de la junta de colocación: 6 mm
Recommended joint width: 6 mm



Azul/Azul oscuro
Blue/Dark blue

**Disponibles otras combinaciones de color bajo pedido.
**Other color combinations available on demand.

Piezas señalización Marking tiles

NUMERACIÓN DE CALLES

LANE MARKING TILES

[244x119x8 mm]

Vertical Cod. 904123 [JG310]
Horizontal Cod. 904122 [JG310]

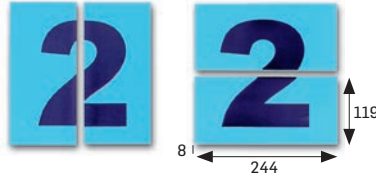

SEÑALIZACIÓN DE PROFUNDIDAD

DEPTH MARKING TILES

[244x119x8 mm]

Vertical Cod. 904398 [JG310]
Horizontal Cod. 904397 [JG310]

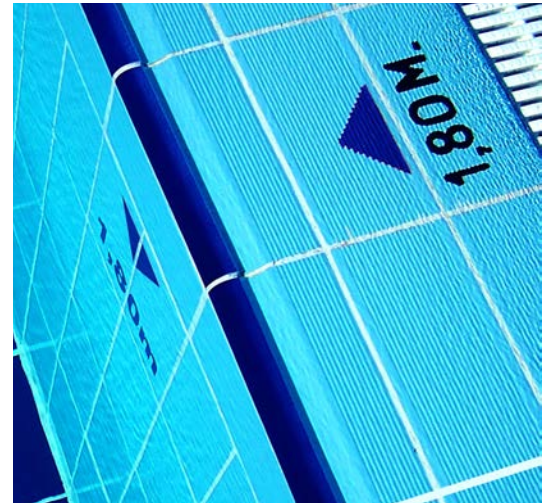

PIEZAS PERSONALIZADAS CORPORATIVAS

Gracias a la tecnología de inyección digital **Klinkjet** podemos realizar piezas de señalización personalizadas, así como piezas con logotipos, advertencias, señaléticas de peligro y un sinfín de diseños que ayuden a personalizar cada proyecto y cada instalación. Contacta con fábrica para más información.

CORPORATE CUSTOMIZED TILES

Thanks to **Klinkjet** digital injection technology we can make custom signalling pieces, as well as pieces with logos, warnings, danger signs and a myriad of designs that will help you to customize each project and each installation. Contact with factory for more information.



Señalética industrial / Industrial signalling



Señalética metro de Bilbao / Bilbao Metro signalling



Sistemas de coronación

Edging systems

El uso de piezas cerámicas porcelánicas o klinker para el revestimiento completo de una piscina supone una **resistencia total** tanto a los agentes químicos o naturales utilizados en el tratamiento de aguas, como a los productos y métodos de limpieza utilizados en las instalaciones y entornos acuáticos. Además, todas las piezas cerámicas porcelánicas y klinker son idóneas para uso tanto en **exteriores como en interiores**, aportando los elementos necesarios para que las instalaciones cumplan la **normativa**. Aportan, también, calidez y confort a los espacios acuáticos y zonas aledañas.

ACEPOOL dispone de una amplia oferta de sistemas de coronación tanto desbordantes como no desbordantes, así como de piezas de base y de acabado, para piscinas que cumplen con todo lo anterior y que proporcionan un sinfín de posibilidades para crear diseños únicos, sea cual sea el estilo o inspiración.

Los sistemas de **coronación desbordantes** son sistemas para piscinas con canal perimetral de rebose compuesto por piezas porcelánicas o klinker fabricadas por extrusión que se pueden colocar sobre piezas de hormigón prefabricado o directamente sobre la estructura del vaso. Sus principales ventajas son:

- La **facilidad de instalación**, simplificando al máximo el proceso desde el hormigonado o gunitado del vaso, requiriendo únicamente superficies de partida planas;
- La **disminución de tiempos de ejecución y materiales** necesarios;
- Los acabados de **mayor calidad**.

Las piezas de borde desbordante son recibidas por las piezas de hormigón prefabricado y cumplen una **triple función**:

- **Estructural**: al aportar la inclinación necesaria para generar un borde desbordante tipo playa,
- **De revestimiento**: al ser el último material de acabado de la piscina,
- **De seguridad**: al poseer resistencia al deslizamiento en su superficie y delimitar claramente la ubicación de la arista del vaso mediante un color más oscuro, además de contar con una hendidura que permite servir como asidero.

When our porcelain or clinker tiles are used to line, edge and surround the whole of a pool, they guarantee **full resistance** to both the chemicals or natural agents used to treat the water and to the cleaning products and cleaning methods used there. All our porcelain and clinker tiles **can be used indoors and out**, where they **fulfil all the necessary requirements** of relevant standards. They also bring warmth and comfort to pool and spa facilities and their surrounding areas.

ACEPOOL manufactures a wide range of coping systems for overflow and non-overflow pools, in addition to field tiles and special tiles pieces so as to ensure pools able to meet all the above guarantees. Its systems also offer broad design potential, allowing for the creation of one-of-a-kind pools, whatever the style or source of inspiration.

Overflow coping systems are suitable for pools with perimeter overflow channels. Made of extruded porcelain or clinker tiles, they can either be laid on top of precast concrete gutters or else directly round the edge of the pool. Their main advantages are:

- **Easy installation**, simplifying the process to the full from the moment the inside of the pool is concreted or gunited. All that it requires is a flat substrate;
- A **reduction in installation times and materials**;
- **Better-quality** finishes.

The overflow coping tiles are laid on top of precast concrete gutters, where they fulfil a **triple function**:

- **Structural** support by providing with the necessary sloping edge for overflow pools;
- **Cladding** because this is the top covering round the pool;
- **Safety**, thanks to the tiles' non-slip grip and role in marking the edge of the pool with their darker colour and groove, which can also be used as a hand grip.

Tipos de sistema de borde desbordante Types of overflow coping systems

SISTEMA B-33 B-33 SYSTEM

Sistema adaptado a piscinas no necesariamente deportivas. Se compone de un borde desbordante y aloja también la rejilla cerámica, bien en su versión rígida o en su versión flexible. Puede utilizarse la cerámica directamente sobre la estructura del vaso o combinarse con las piezas de hormigón B-33 para generar el soporte del borde y el canal perimetral.

A specially adapted system also suitable for pools not for sports use, made up of overflow coping tiles which can accommodate a rigid or flexible ceramic grating. The coping tiles can be laid directly on the concrete edge of the pool or on top of B-33 supporting precast concrete gutters.

SISTEMA GA-SPA GA-SPA SYSTEM

Sistema compuesto por una única pieza porcelánica que realiza la función de borde y apoyo de rejilla, para piscina deportiva, capaz de alojar los dos anchos estándar de rejilla de 245 y 195 mm sin necesidad de cortar o adaptar piezas. Se puede colocar directamente sobre la estructura del vaso con las piezas porcelánicas de revestimiento del interior del canal o en combinación con las piezas de hormigón prefabricado (GA-SPA).

A system for sports pools, made up of porcelain tiles that act as both a coping tile and support for a grating. This system can accommodate gratings in two standard widths (245 and 195 mm wide) without having to cut or adapt the tiles. The tiles can be laid directly on the concrete edge of the pool and also used to line the overflow channel or they can be laid on top of precast concrete gutters (GA-SPA).

SISTEMA FINLANDÉS FINNISH SYSTEM

Sistema compuesto por una pieza de borde más apoyos de rejilla, que se puede colocar directamente sobre la estructura del vaso con las piezas porcelánicas de revestimiento del interior del canal o en combinación con las piezas de hormigón (GA-SPA). Es capaz de alojar los dos anchos estándar de rejilla de 245 y 195 mm sin necesidad de cortar o adaptar piezas.

A system made up of coping tiles that also act as a support for a grating. The tiles can be laid directly onto the concrete edge of the pool and also used to line the overflow channel or they can be laid on top of precast concrete gutters (GA-SPA-U). The tiles can accommodate gratings in two standard widths (245 and 195 mm wide).

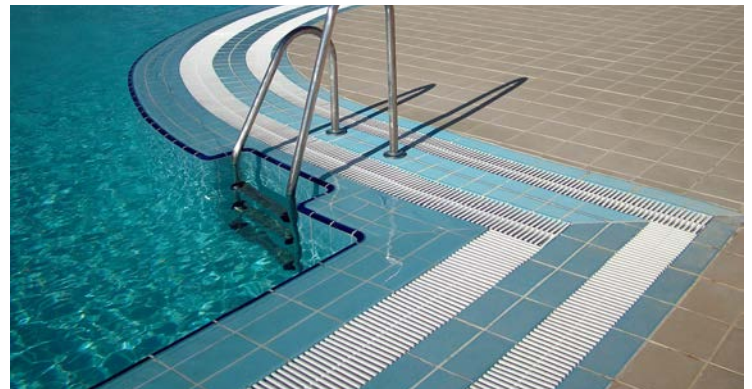
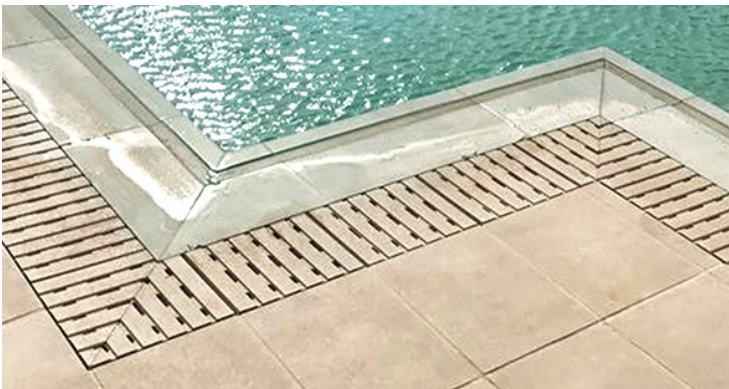

Los sistemas de **coronación no desbordantes** son ideales para aquellas piscinas que bien por dimensiones o bien por circunstancias no requieran de un canal perimetral de rebose. Es posible coronarlas mediante bordes rectos o tradicionales redondeados, que permiten conservar las **posibilidades de diseño y continuidad** de la playa o interior del vaso y coronar de **forma segura** la piscina. Se puede acompañar a estas coronaciones o playas con una **rejilla cerámica** de idéntico acabado para canales de recogida de aguas superficiales y evitar su vertido al vaso.

Non-overflow coping systems are ideal for pools that do not need an overflow channel due to their size or characteristics. These pools can have straight sides or more conventional rounded ones. With this system, the design of the pool and its poolside areas can be maintained while also ensuring **safe edging**. The coping system and poolside area can incorporate **ceramic gratings** in the same finish to drain away surface water and prevent it from running into the pool.

Sea cual sea el sistema de coronación instalado, los sistemas **ACEPOOL** son garantía de **funcionalidad, durabilidad, seguridad, calidad y diseño**, lo que se traduce en una apuesta segura.

Whichever coping system is used, ACEPOOL's systems offer **183** the assurance of **functionality, durability, safety, quality and design appeal**.

Sistemas de coronación desbordantes Overflow edging systems

SISTEMA B-33 SYSTEM PORCELÁNICO PORCELAIN TILES



BORDE DESBORDANTE 60

OVERFLOWING EDGE 60

Antideslizante · Anti slip
[597x325x25 mm]

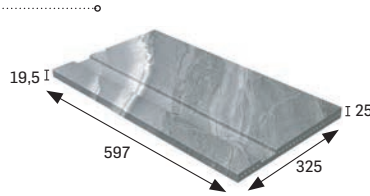

- Urban Blanco** Cod. 904313 [PZ650]
- Urban Gris** Cod. 904314 [PZ650]
- Urban Beige** Cod. 904315 [PZ650]
- Urban Grafito** Cod. 904781 [PZ650]
- Ítaca Gris** Cod. 904382 [PZ650]
- Ítaca Mix** Cod. 904381 [PZ650]
- Ordesa Gris** Cod. 904650 [PZ650]
- Ordesa Beige** Cod. 904651 [PZ650]
- Ordesa Natural** Cod. 905523 [PZ650]
- Ordesa Marrón** Cod. 904652 [PZ650]
- Tibet Blanco** Cod. 904983 [PZ650]
- Tibet Gris** Cod. 904984 [PZ650]
- Tibet Beige** Cod. 904985 [PZ650]
- Tibet Antracita** Cod. 904986 [PZ650]

CANALETA*

OVERFLOW CHANNEL

Antideslizante · Anti slip
[297x244x30 mm]

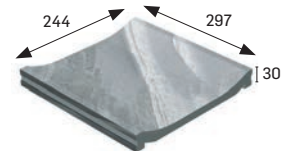

- Urban Blanco** Cod. 904337 [PZ382]
- Urban Gris** Cod. 904338 [PZ382]
- Urban Beige** Cod. 904339 [PZ382]
- Urban Grafito** Cod. 904787 [PZ382]
- Ítaca Gris** Cod. 903019 [PZ382]
- Ítaca Mix** Cod. 903017 [PZ382]
- Ordesa Gris** Cod. 904668 [PZ382]
- Ordesa Beige** Cod. 904669 [PZ382]
- Ordesa Natural** Cod. 905529 [PZ382]
- Ordesa Marrón** Cod. 904670 [PZ382]
- Tibet Blanco** Cod. 905007 [PZ382]
- Tibet Gris** Cod. 905008 [PZ382]
- Tibet Beige** Cod. 905009 [PZ382]
- Tibet Antracita** Cod. 905010 [PZ382]

* Disponible Canaleta con desagüe.
* Overflow channel with drainage available.

ESQ. INT. BORDE DESBORDANTE

OVERFLOWING INTERNAL EDGE

Antideslizante · Anti slip
[325x444x119 mm]

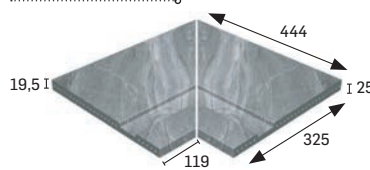

- Urban Blanco** Cod. 904317 [JG762]
- Urban Gris** Cod. 904318 [JG762]
- Urban Beige** Cod. 904319 [JG762]
- Urban Grafito** Cod. 904782 [JG762]
- Ítaca Gris** Cod. 903879 [JG762]
- Ítaca Mix** Cod. 903899 [JG762]
- Ordesa Gris** Cod. 904653 [JG762]
- Ordesa Beige** Cod. 904654 [JG762]
- Ordesa Natural** Cod. 905524 [JG762]
- Ordesa Marrón** Cod. 904655 [JG762]
- Tibet Blanco** Cod. 904987 [JG762]
- Tibet Gris** Cod. 904988 [JG762]
- Tibet Beige** Cod. 904989 [JG762]
- Tibet Antracita** Cod. 904990 [JG762]

ESQ. EXT. BORDE DESBORDANTE

OVERFLOWING EXTERNAL EDGE

Antideslizante · Anti slip
[325x418x93 mm]

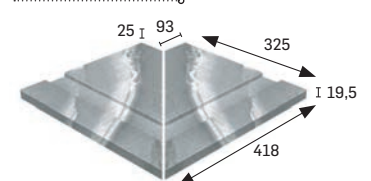

- Urban Blanco** Cod. 904321 [JG762]
- Urban Gris** Cod. 904322 [JG762]
- Urban Beige** Cod. 904323 [JG762]
- Urban Grafito** Cod. 904783 [JG762]
- Ítaca Gris** Cod. 903878 [JG762]
- Ítaca Mix** Cod. 903898 [JG762]
- Ordesa Gris** Cod. 904656 [JG762]
- Ordesa Beige** Cod. 904657 [JG762]
- Ordesa Natural** Cod. 905525 [JG762]
- Ordesa Marrón** Cod. 904658 [JG762]
- Tibet Blanco** Cod. 904991 [JG762]
- Tibet Gris** Cod. 904992 [JG762]
- Tibet Beige** Cod. 904993 [JG762]
- Tibet Antracita** Cod. 904994 [JG762]

184

PISCINA PÚBLICA RECREATIVA Y PRIVADA PUBLIC RECREATIONAL AND PRIVATE POOL

	Espe- sor (mm) Thickness (mm)	U.M.*	U.M./Caja U.M./Box	U.M./Palet U.M./Pallet	Pzs./U.M. Pcs./U.M.	Pzs./Caja Pcs./Box	Kg./U.M. Kg./U.M.	Kg./Caja Kg./Box	Kg./Palet Kg./Pallet
Borde desbordante 60 Overflowing edge 60	25	Pz. Pc.	2	60	1	2	9,028	18,056	563
Canaleta Overflow channel	30	Pz. Pc.	4	288	1	4	2,5	10,2	734
Esq. int. borde desbordante Overflowing internal edge	25	Jg. Set	2	-	2	4	7	14	-
Esq. ext. borde desbordante Overflowing external edge	25	Jg. Set	2	-	2	4	7	14	-
Rejilla monocompact ranurada Monocompact grooved grid	25	Pz. Pc.	5	315	1	5	4,2	20,8	1310
Esquina rejilla Corner grid	25	Set Set	1	-	1	2	7,96	7,96	-
Rejilla flexible ranurada Grooved Flexible grid	25	Pz. Pc.	1	30	1	1	12,7	12,7	381

* Unidad de Medida. Los artículos medidos en m² o ml se sirven contando la junta normal entre piezas.
* Unit of Measure. Items measured in sqm or lm are delivered assuming average joint between pieces.

Anchura recomendada de la junta de colocación: Consultar pág. 15.
Recommended joint width: See pg. 15.

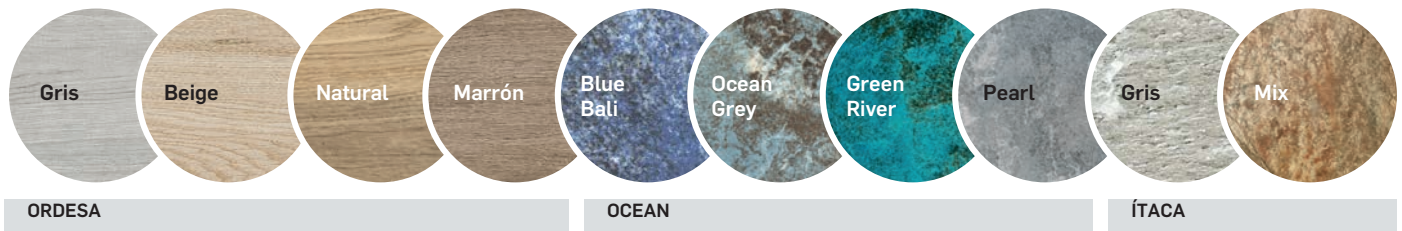

REJILLA MONOCOMPACT RANURADA

MONOCOMPACT GROOVED GRID

Antideslizante / Anti slip **

[291x244x25 mm]

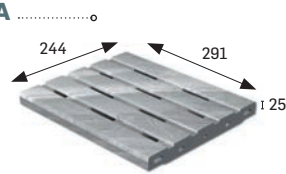

- Urban Blanco** Cod. 905056 [PZ595]
- Urban Gris** Cod. 904909 [PZ595]
- Urban Beige** Cod. 905058 [PZ595]
- Urban Grafito** Cod. 905059 [PZ595]
- Ítaca Gris** Cod. 905044 [PZ595]
- Ítaca Mix** Cod. 905045 [PZ595]
- Ordesa Gris** Cod. 904659 [PZ595]
- Ordesa Beige** Cod. 905038 [PZ595]
- Ordesa Natural** Cod. 905526 [PZ595]
- Ordesa Marrón** Cod. 905037 [PZ595]
- Tibet Blanco** Cod. 904995 [PZ595]
- Tibet Gris** Cod. 904996 [PZ595]
- Tibet Beige** Cod. 904997 [PZ595]
- Tibet Antracita** Cod. 904998 [PZ595]



** En rejillas, los agujeros siempre deben ir paralelos al vaso para su mayor resistencia, con canal de 250 mm de ancho.

** Install the grids with the holes always parallel to the pool vessel to get a greater resistance, with a channel 250 mm wide

ESQUINA REJILLA

CORNER GRID

Antideslizante · Anti slip

[388x244x25 x144 mm]

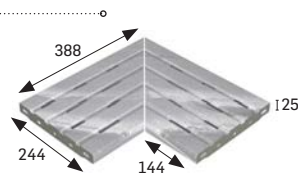

- Urban Blanco** Cod. 905052 [JG761]
- Urban Gris** Cod. 905053 [JG761]
- Urban Beige** Cod. 905054 [JG761]
- Urban Grafito** Cod. 905055 [JG761]
- Ítaca Gris** Cod. 905046 [JG761]
- Ítaca Mix** Cod. 905047 [JG761]
- Ordesa Gris** Cod. 905039 [JG761]
- Ordesa Beige** Cod. 905040 [JG761]
- Ordesa Natural** Cod. 905527 [JG761]
- Ordesa Marrón** Cod. 905041 [JG761]
- Tibet Blanco** Cod. 904999 [JG761]
- Tibet Gris** Cod. 905000 [JG761]
- Tibet Beige** Cod. 905001 [JG761]
- Tibet Antracita** Cod. 905002 [JG761]

REJILLA FLEXIBLE RANURADA

GROOVED FLEXIBLE GRID *

Antideslizante · Anti slip

[245x25 x52 mm]

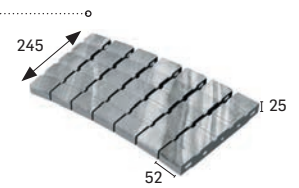

- Urban Blanco** Cod. 905048 [ML780]
- Urban Gris** Cod. 905049 [ML780]
- Urban Beige** Cod. 905050 [ML780]
- Urban Grafito** Cod. 905051 [ML780]
- Ítaca Gris** Cod. 905042 [ML780]
- Ítaca Mix** Cod. 905043 [ML780]
- Ordesa Gris** Cod. 904908 [ML780]
- Ordesa Beige** Cod. 905035 [ML780]
- Ordesa Natural** Cod. 905528 [ML780]
- Ordesa Marrón** Cod. 905036 [ML780]
- Tibet Blanco** Cod. 905003 [ML780]
- Tibet Gris** Cod. 905004 [ML780]
- Tibet Beige** Cod. 905005 [ML780]
- Tibet Antracita** Cod. 905006 [ML780]

* Disponible bajo pedido. / Available on demand.

Ver/See pg. 14.

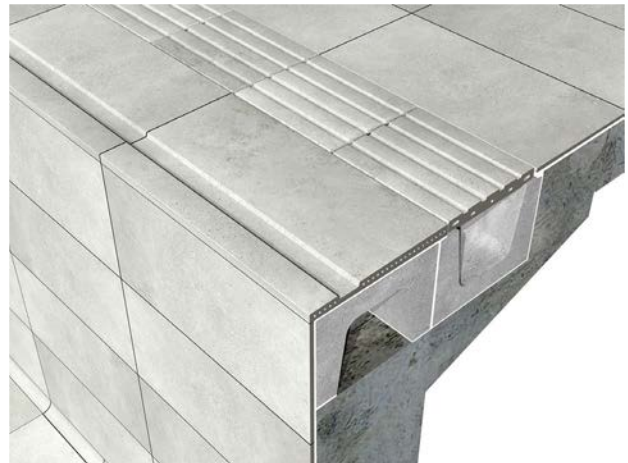
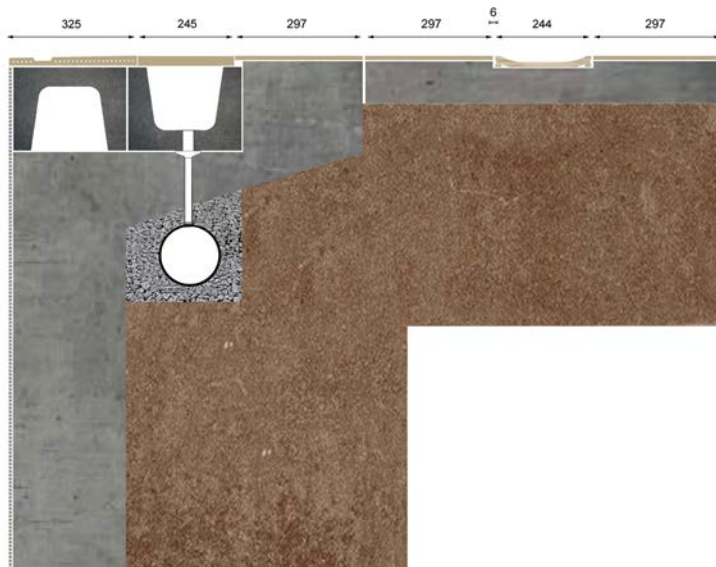

Sistemas de coronación desbordantes Overflow edging systems

SISTEMA B-33 SYSTEM KLINKER



BORDE DESBORDANTE

OVERFLOWING EDGE

Antideslizante · Anti slip
[330x325x25 mm]

Natural	Cod. 902795	[PZ225]
Cotto Blanco	Cod. 902794	[PZ225]
Cotto Gris	Cod. 901985	[PZ225]
Columbia Beige	Cod. 901674	[PZ245]
Columbia Aguamarina	Cod. 901675	[PZ245]

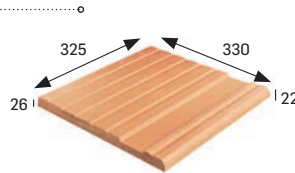

CANALETA*

OVERFLOW CHANNEL

Antideslizante · Anti slip
[297x244x30 mm]

Natural	Cod. 901871	[PZ250]
Cotto Blanco	Cod. 901869	[PZ250]
Cotto Gris	Cod. 901889	[PZ250]
Columbia Beige	Cod. 901894	[PZ250]
Columbia Aguamarina	Cod. 901895	[PZ250]

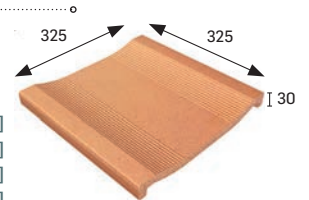

* Disponible Canaleta con desagüe.
* Overflow channel with drainage available.

ESQ. INT. BORDE DESBORDANTE

OVERFLOWING INTERNAL EDGE

Antideslizante · Anti slip
[325x444x119 mm]

Natural	Cod. 901931	[JG395]
Cotto Blanco	Cod. 901936	[JG395]
Cotto Gris	Cod. 901941	[JG395]
Columbia Beige	Cod. 901961	[JG395]
Columbia Aguamarina	Cod. 901956	[JG395]

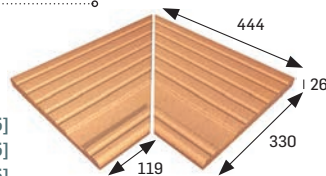

ESQ. EXT. BORDE DESBORDANTE

OVERFLOWING EXTERNAL EDGE

Antideslizante · Anti slip
[325x418x93 mm]

Natural	Cod. 901932	[JG395]
Cotto Blanco	Cod. 901937	[JG395]
Cotto Gris	Cod. 901942	[JG395]
Columbia Beige	Cod. 901962	[JG395]
Columbia Aguamarina	Cod. 901957	[JG395]

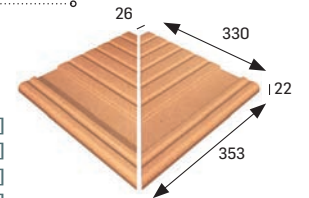

186

REJILLA CERÁMICA MONOCOMPACT

MONOCOMPACT CERAMIC GRID **

Antideslizante · Anti slip
[297x315x14 mm]

Natural	Cod. 902972	[PZ645]
Cotto Blanco	Cod. 902973	[PZ645]
Cotto Gris	Cod. 902974	[PZ645]
Columbia Beige	Cod. 902976	[PZ645]
Columbia Aguamarina	Cod. 902977	[PZ645]
Orión Beige	Cod. 904494	[PZ645]
Orión Gris	Cod. 904486	[PZ645]
Orión Jade	Cod. 904490	[PZ645]
Orión Antracita	Cod. 904613	[PZ645]

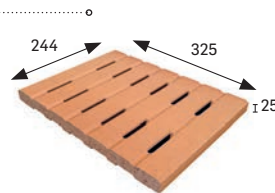

ESQUINA REJILLA

CORNER GRID

Antideslizante · Anti slip
[293x244x25x80 mm]

Natural	Cod. 901489	[JG750]
Cotto Blanco	Cod. 901490	[JG750]
Cotto Gris	Cod. 901491	[JG750]
Columbia Beige	Cod. 901494	[JG750]
Columbia Aguamarina	Cod. 901493	[JG750]
Orión Beige	Cod. 904495	[JG750]
Orión Gris	Cod. 904487	[JG750]
Orión Jade	Cod. 904491	[JG750]
Orión Antracita	Cod. 904614	[JG750]

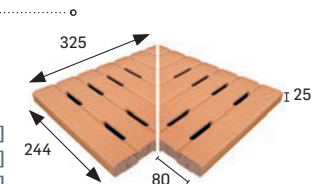

** En rejillas los agujeros siempre deben ir perpendiculares al vaso para una mayor resistencia, con canal de 250 mm de ancho.
** Install the grids with the holes always perpendicular to the pool vessel to get a greater resistance, with a channel 250 mm wide.

	Espesor (mm) Thickness (mm)	U.M.*	U.M./Caja U.M./Box	U.M./Palet U.M./Pallet	Pzs./U.M. Pcs./U.M.	Pzs./Caja Pcs./Box	Kg./U.M. Kg./U.M.	Kg./Caja Kg./Box	Kg./Palet Kg./Pallet
Borde desbordante Overflowing edge	22-26	Pz. Pc.	4	128	1	4	5	20	640
Canaleta Overflow channel	30	Pz. Pc.	3	99	1	3	4,43	13,3	438,6
Esq. int. borde desbordante Overflowing internal edge	26	Jg. Set	2	-	2	4	8	16	-
Esq. ext. borde desbordante Overflowing external edge	26	Jg. Set	2	-	2	4	5,4	10,8	-
Rejilla cerámica monocompact Monocompact ceramic grid	25	Pz. Pc.	6	378	1	6	3,58	21,5	-
Esquina rejilla Corner grid	25	Set Set	3	-	2	6	4,69	14,07	-

* Unidad de Medida. Los artículos medidos en m² o ml se sirven contando la junta normal entre piezas.
* Unit of Measure. Items measured in sqm or lm are delivered assuming average joint between pieces.

Anchura recomendada de la junta de colocación: Consultar pág. 15.
Recommended joint width: See pg. 15.

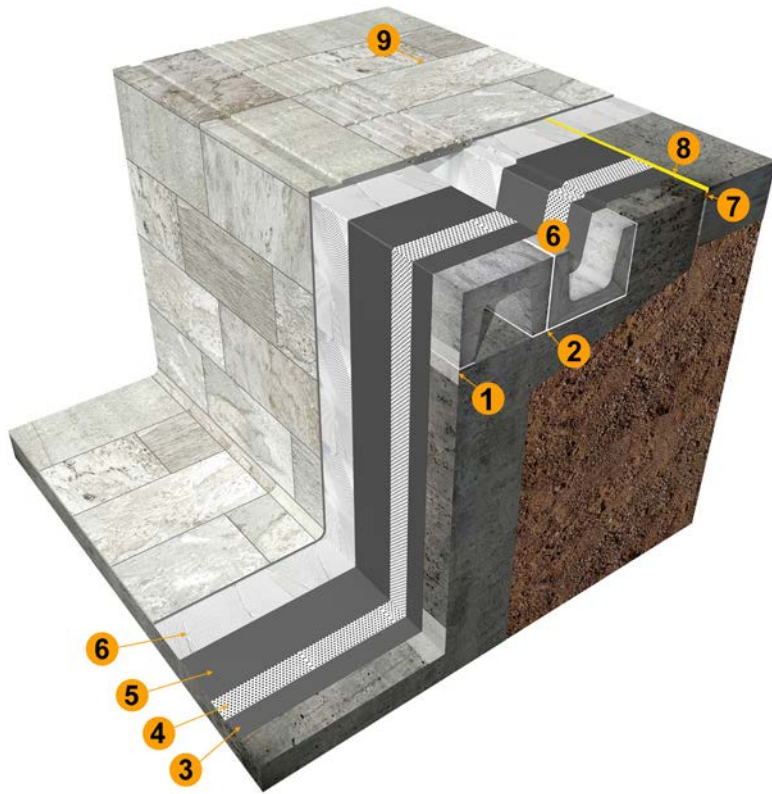

- 1** Banda elástica de impermeabilización.
Elastic waterproofing membrane.
- 2** Cemento cola C2 TE S1, para inmersión contInua.
C2 TE S1 cement-based adhesive for surfaces subject to continuous immersion.
- 3** 1ª Capa de impermeabilizante.
1st Waterproofing layer.
- 4** Malla impermeabilizante.
Waterproofing mesh.
- 5** 2ª Capa de impermeabilizante.
2nd Waterproofing layer.
- 6** Cemento cola C2 TE S1, para inmersión contInua.
C2 TE S1 cement-based adhesive for surfaces subject to continuous immersion.
- 7** Junta hidroexpansiva.
Hydro-expansive joint.
- 8** Sellado de la junta de dilatación con masilla antiácida, elástica e impermeable.
Expansion joint sealed with an acid-proof, waterproof elastic putty.
- 9** Rejuntado de junta de las baldosas con CG2 W.
CG2 W tile grouting.

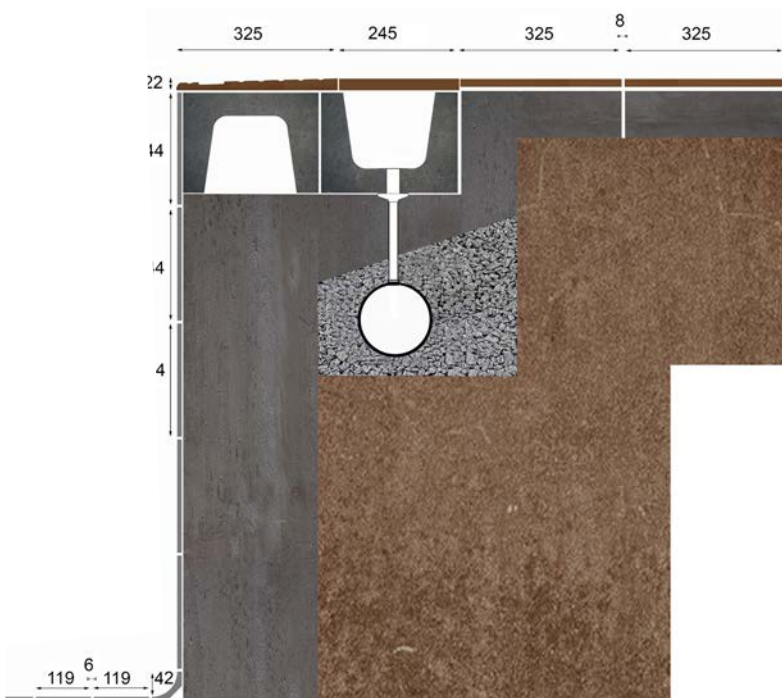

SISTEMA **B-33** SYSTEM

PIEZAS DE HORMIGÓN CONCRETE PIECES

PIEZA ESTÁNDAR B-33

B-33 STANDARD PIECE

Cod. 902857 [PZ135]

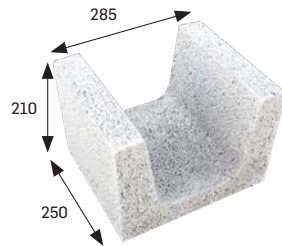

PIEZA MACIZA ESQUINA DE NICHO/ANCLAJE CORCHERA B-33

B-33 NICHE CORNER PIECE/LANE ROPE FIXING PIECE

Cod. 902859 [PZ255]

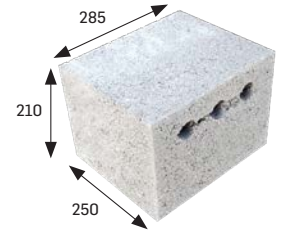

PIEZA NICHO B-33

B-33 NICHE PIECE

Cod. 902858 [PZ255]

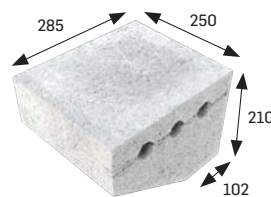

PIEZA ESQUINA INTERIOR B-33

B-33 INTERNAL CORNER PIECE

Cod. 902860 [JG745]

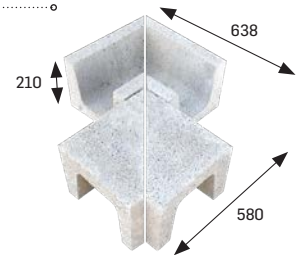

PIEZA ESQUINA EXTERIOR B-33

B-33 EXTERNAL CORNER PIECE

Cod. 902860 [JG745]

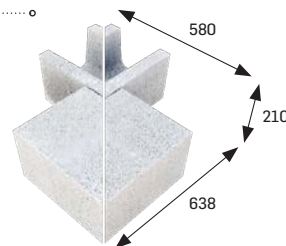

	U.M.*	
Pieza estándar B-33 B-33 Standard piece	Pz. Pc.	
Pieza maciza esquina de nicho/anclaje corchera B-33 B-33 Niche corner piece/lane rope fixing piece	Pz. Pc.	
Pieza nicho B-33 B-33 Niche piece	Pz. Pc.	
Pieza esquina interior B-33 B-33 Internal corner piece	Kit Kit	
Pieza esquina exterior B-33 B-33 External corner piece	Kit Kit	

Consultar datos de embalaje a fábrica.

Ask the factory for packing details.

NICHO B-33 CERRADO CLOSED B-33 NICHE

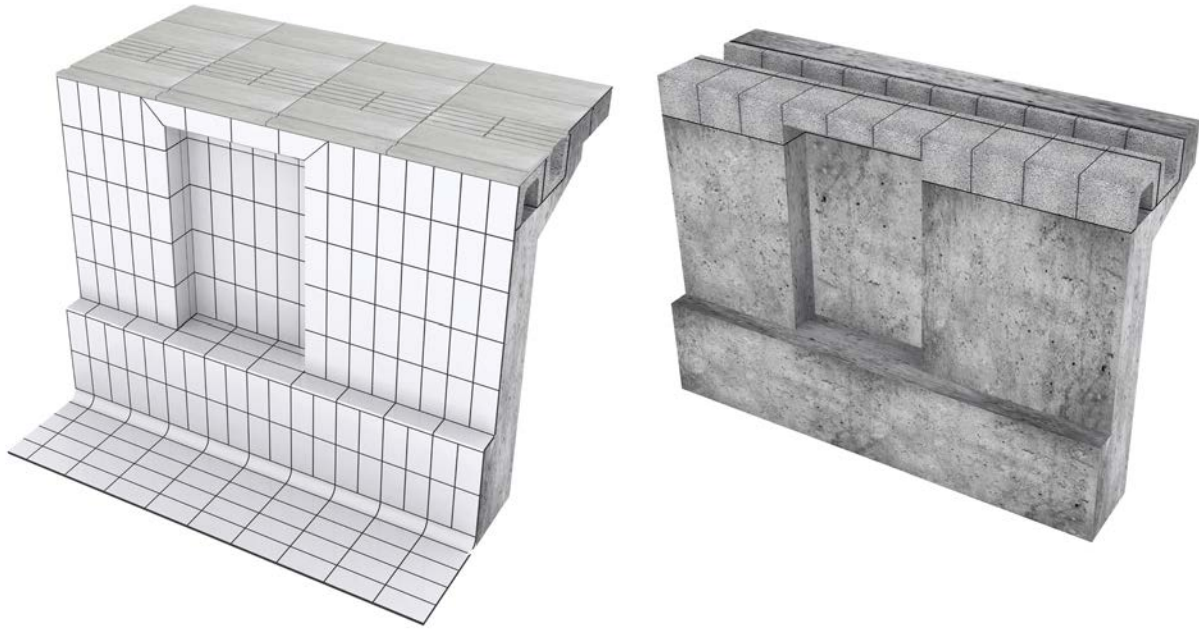

NICHO B-33 ABIERTO OPEN B-33 NICHE

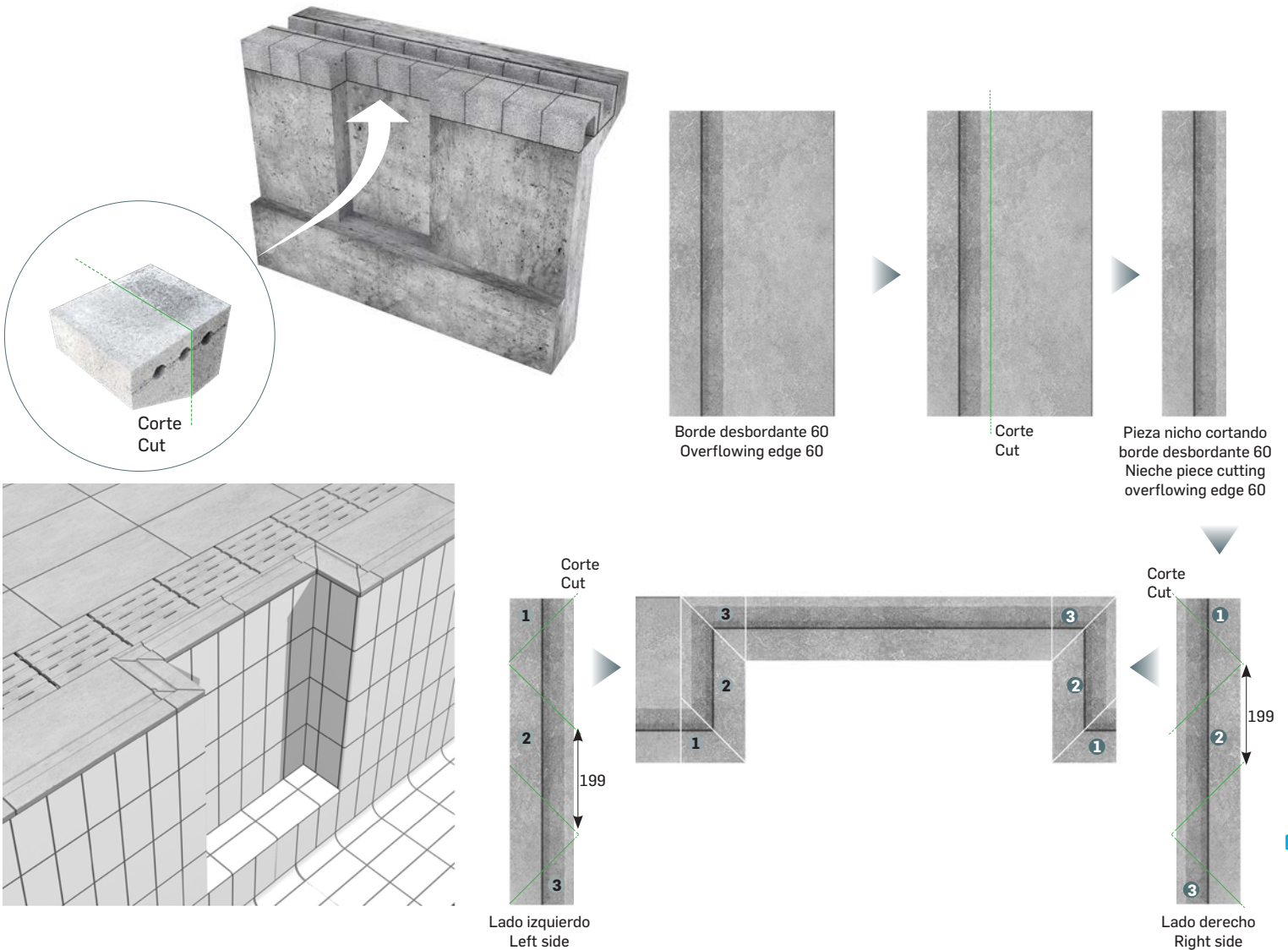

SISTEMA GA-SPA SYSTEM



Bases antideslizantes Anti slip tiles
Aciker Natural / Natural Aciker
Blanco / White
Aciker Gris / Grey Aciker

BORDE GA SPA

GA SPA EDGE
[244x276x38 mm]

Antideslizante - Mate / Anti slip - Matt

Blanco/Gris

White/Grey Cod. 905671 [PZ370]

Azul/Azul oscuro

Blue/Dark blue Cod. 905672 [PZ370]

Blanco/Azul oscuro

White/Dark blue Cod. 905673 [PZ370]

Natural/Azul oscuro

Natural/Dark blue Cod. 905674 [PZ370]

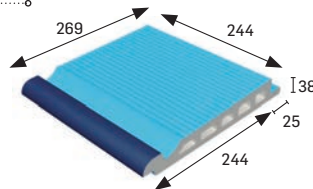

ESQ. INT. BORDE GA SPA

GA SPA EDGE INT. CORNER
[276x320 mm]

Antideslizante - Mate / Anti slip - Matt

Blanco/Gris

White/Grey Cod. 905675 [JG710]

Azul/Azul oscuro

Blue/Dark blue Cod. 905676 [JG710]

Blanco/Azul oscuro

White/Dark blue Cod. 905677 [JG710]

Natural/Azul oscuro

Natural/Dark blue Cod. 905678 [JG710]

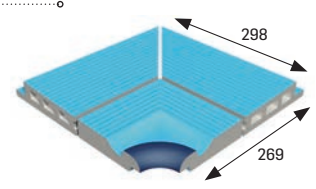

ESQ. EXT. BORDE GA SPA

GA SPA EDGE EXT. CORNER
[276x307 mm]

Antideslizante - Mate / Anti slip - Matt

Blanco/Gris

White/Grey Cod. 905679 [JG710]

Azul/Azul oscuro

Blue/Dark blue Cod. 905680 [JG710]

Blanco/Azul oscuro

White/Dark blue Cod. 905681 [JG710]

Natural/Azul oscuro

Natural/Dark blue Cod. 905682 [JG710]

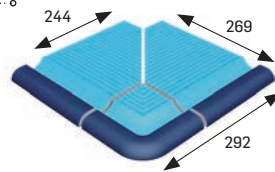

NICHO GA SPA

GA SPA NICHE
[244x100 mm]

Antideslizante - Mate / Anti slip - Matt

Blanco/Gris

White/Grey Cod. 905683 [PZ295]

Azul/Azul oscuro

Blue/Dark blue Cod. 905684 [PZ295]

Blanco/Azul oscuro

White/Dark blue Cod. 905685 [PZ295]

Natural/Azul oscuro

Natural/Dark blue Cod. 905686 [PZ295]

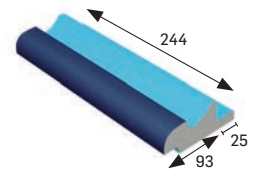

ESQ. IZDA. NICHO GA SPA

GA SPA NICHE LEFT CORNER
[124x244x100 mm]

Antideslizante - Mate / Anti slip - Matt

Blanco/Gris

White/Grey Cod. 905687 [PZ445]

Azul/Azul oscuro

Blue/Dark blue Cod. 905688 [PZ445]

Blanco/Azul oscuro

White/Dark blue Cod. 905689 [PZ445]

Natural/Azul oscuro

Natural/Dark blue Cod. 905690 [PZ445]

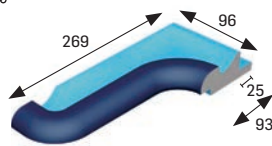

ESQ. DCHA. NICHO GA SPA

GA SPA NICHE RIGHT CORNER
[124x244x100 mm]

Antideslizante - Mate / Anti slip - Matt

Blanco/Gris

White/Grey Cod. 905691 [PZ445]

Azul/Azul oscuro

Blue/Dark blue Cod. 905692 [PZ445]

Blanco/Azul oscuro

White/Dark blue Cod. 905693 [PZ445]

Natural/Azul oscuro

Natural/Dark blue Cod. 905694 [PZ445]

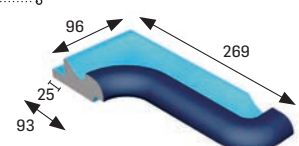

	Espesor (mm) Thickness (mm)	U.M.*	U.M./Caja U.M./Box	U.M./Palet U.M./Pallet	Pzs./U.M. Pcs./U.M.	Pzs./Caja Pcs./Box	Kg./U.M. Kg./U.M.	Kg./Caja Kg./Box	Kg./Palet Kg./Pallet
Borde GA-SPA GA-SPA edge	-	Pz. Pc.	4	256	1	4	2,9	11,6	742
Esq. int. borde GA-SPA GA-SPA edge int. corner	-	Set Set	2	-	3	6	3,8	7,6	-
Esq. ext. borde GA-SPA GA-SPA edge ext. corner	-	Set Set	2	-	3	6	3,8	7,6	-
Nicho GA-SPA GA-SPA niche	-	Pz. Pc.	7	448	1	7	1	7	448
Esq. izda. nicho GA-SPA GA-SPA niche left corne	-	Pz. Pc.	3	-	1	3	0,8	2,4	-
Esq. dcha. nicho GA-SPA GA-SPA niche right corner	-	Pz. Pc.	3	-	1	3	0,8	2,4	-

* Unidad de Medida. Los artículos medidos en m² o ml se sirven contando la junta normal entre piezas.

* Unit of Measure. Items measured in sqm or lm are delivered assuming average joint between pieces.

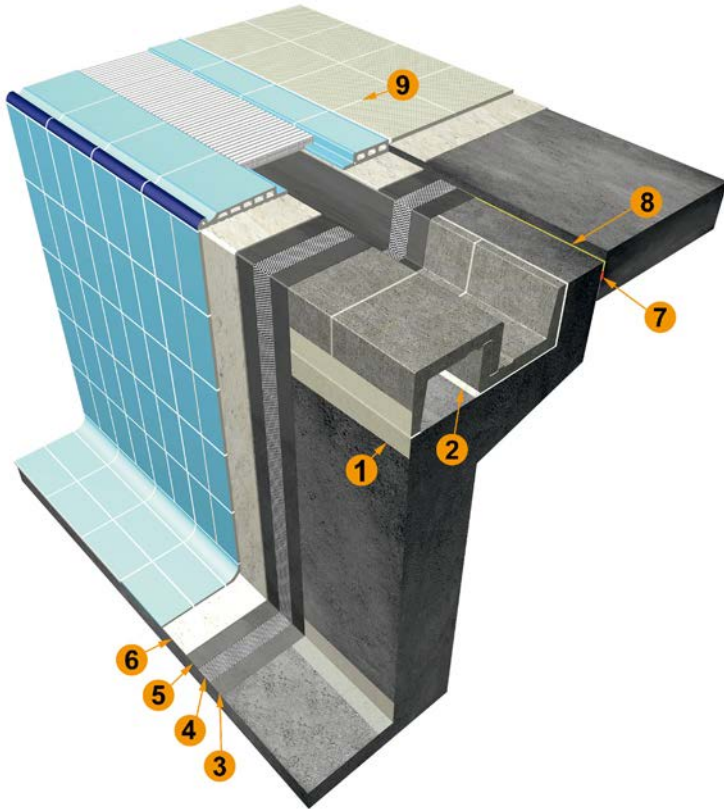

- 1** Banda elástica de impermeabilización.
Elastic waterproofing membrane.

- 2** Cemento cola C2 TE S1, para inmersión contInua.
C2 TE S1 cement-based adhesive for surfaces subject to continuous immersion.

- 3** 1ª Capa de impermeabilizante.
1st Waterproofing layer.

- 4** Malla impermeabilizante.
Waterproofing mesh.

- 5** 2ª Capa de impermeabilizante.
2nd Waterproofing layer.

- 6** Cemento cola C2 TE S1, para inmersión contInua.
C2 TE S1 cement-based adhesive for surfaces subject to continuous immersion.

- 7** Junta hidroexpansiva.
Hydro-expansive joint.

- 8** Sellado de la junta de dilatación con masilla antiácida, elástica e impermeable.
Expansion joint sealed with an acid-proof, waterproof elastic putty.

- 9** Rejuntado de junta de las baldosas con CG2 W.
CG2 W tile grouting.

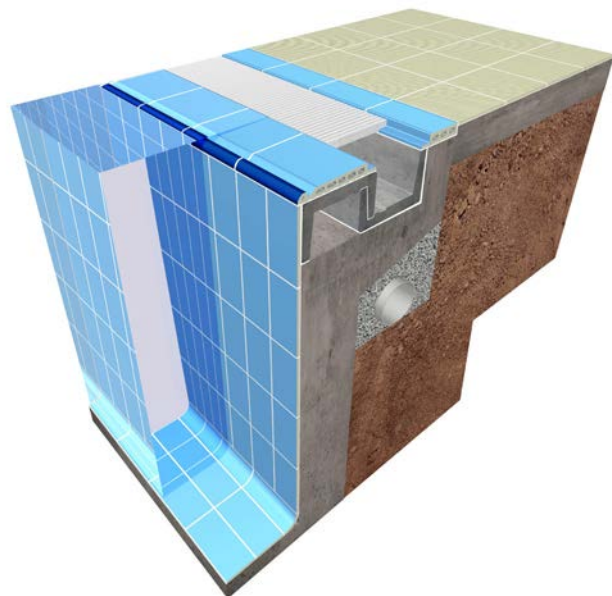
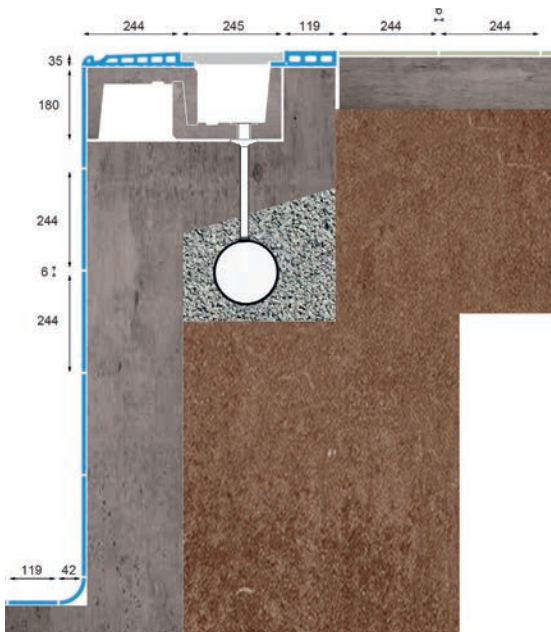

SISTEMA FINLANDÉS FINNISH SYSTEM



Bases antideslizantes Anti slip tiles
Aciker Natural / Natural Aciker
Blanco / White
Aciker Gris / Grey Aciker

BORDE FINLANDÉS

FINNISH EDGE
 [244x119x31 mm]

Antideslizante - Mate / Anti slip - Matt

Blanco/Gris

White/Grey Cod. 905508 [PZ265]

Azul/Azul oscuro

Blue/Dark blue Cod. 905695 [PZ265]

Blanco/Azul oscuro

White/Dark blue Cod. 905696 [PZ265]

Natural/Azul oscuro

Natural/Dark blue Cod. 905697 [PZ265]

Natural Natural Cod. 905698 [PZ265]

Azul Blue Cod. 905699 [PZ265]

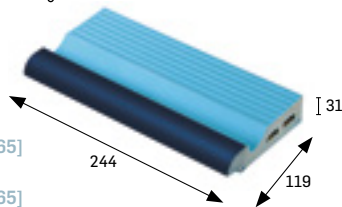

ESQ. INTERIOR BORDE FINLANDÉS

FINNISH EDGE INTERNAL CORNER
 [168x119x28 mm]

Antideslizante - Mate / Anti slip - Matt

Blanco/Gris

White/Grey Cod. 905700 [PZ385]

Azul/Azul oscuro

Blue/Dark blue Cod. 905701 [PZ385]

Blanco/Azul oscuro

White/Dark blue Cod. 905702 [PZ385]

Natural/Azul oscuro

Natural/Dark blue Cod. 905703 [PZ385]

Natural Natural Cod. 905704 [PZ385]

Azul Blue Cod. 905705 [PZ385]

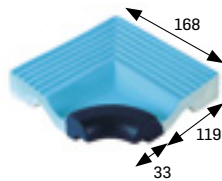

ESQ. EXTERIOR BORDE FINLANDÉS

FINNISH EDGE EXTERNAL CORNER
 [119x119x27 mm]

Antideslizante - Mate / Anti slip - Matt

Blanco/Gris

White/Grey Cod. 905706 [PZ385]

Azul/Azul oscuro

Blue/Dark blue Cod. 905707 [PZ385]

Blanco/Azul oscuro

White/Dark blue Cod. 905708 [PZ385]

Natural/Azul oscuro

Natural/Dark blue Cod. 905709 [PZ385]

Natural Natural Cod. 905710 [PZ385]

Azul Blue Cod. 905711 [PZ385]

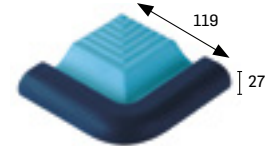

ESQ. INTERIOR INGLETE FINLANDÉS

FINNISH MITER JOINT INTERNAL CORNER
 [119x119 mm]

Antideslizante - Mate / Anti slip - Matt

Blanco/Gris

White/Grey Cod. 905510 [JG350]

Azul/Azul oscuro

Blue/Dark blue Cod. 905712 [JG350]

Blanco/Azul oscuro

White/Dark blue Cod. 905713 [JG350]

Natural/Azul oscuro

Natural/Dark blue Cod. 905714 [JG350]

Natural Natural Cod. 905715 [JG350]

Azul Blue Cod. 905716 [JG350]

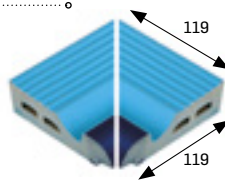

ESQ. EXTERIOR INGLETE FINLANDÉS

MITER JOINT EXTERNAL CORNER
 [119x119 mm]

Antideslizante - Mate / Anti slip - Matt

Blanco/Gris

White/Grey Cod. 905511 [JG350]

Azul/Azul oscuro

Blue/Dark blue Cod. 905717 [JG350]

Blanco/Azul oscuro

White/Dark blue Cod. 905718 [JG350]

Natural/Azul oscuro

Natural/Dark blue Cod. 905719 [JG350]

Natural Natural Cod. 905720 [JG350]

Azul Blue Cod. 905721 [JG350]

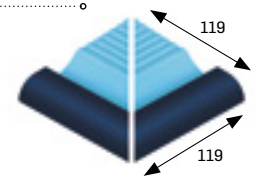

	Espesor (mm) Thickness (mm)	U.M.*	U.M./Caja U.M./Box	U.M./Palet U.M./Pallet	Pzs./U.M. Pcs./U.M.	Pzs./Caja Pcs./Box	Kg./U.M. Kg./U.M.	Kg./Caja Kg./Box	Kg./Palet Kg./Pallet
Borde finlandés Finnish edge	-	Pz. Pc.	8	576	1	8	1,45	11,8	849,6
Esq. int. borde finlandés Finnish edge int. corner	-	Pz. Pc.	4	-	1	4	0,6	2,5	-
Esq. ext. borde finlandés Finnish edge ext. corner	-	Pz. Pc.	4	-	1	4	0,4	1,5	-
Esq. interior inglete finlandés Finnish miter joint internal corner	-	Set Set	4	-	2	8	0,6	2,5	-
Esq. exterior inglete finlandés Finnish miter joint external corner	-	Set Set	4	-	2	8	0,4	1,5	-

* Unidad de Medida. Los artículos medidos en m² o ml se sirven contando la junta normal entre piezas.

* Unit of Measure. Items measured in sqm or lm are delivered assuming average joint between pieces.

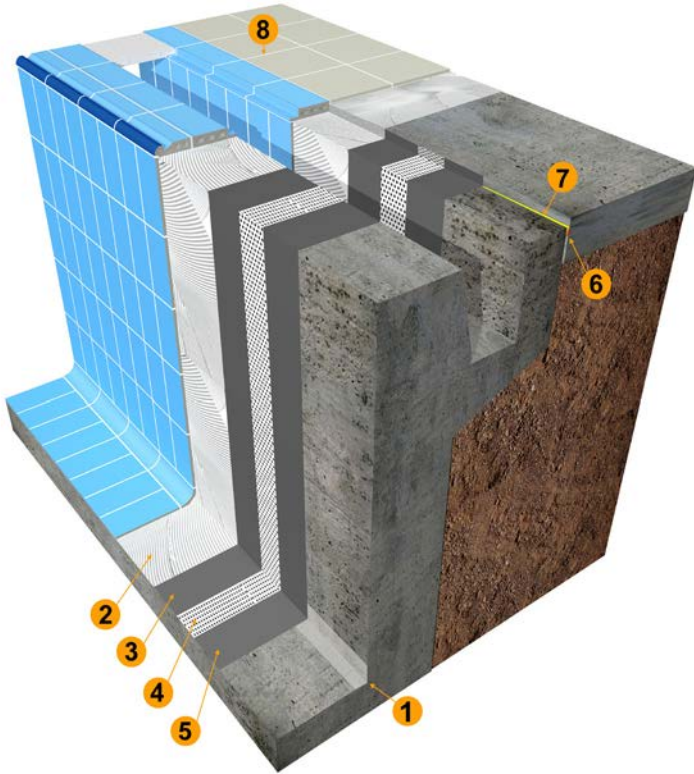

- 1** Banda elástica de impermeabilización.
Elastic waterproofing membrane.

- 2** Cemento cola C2 TE S1, para inmersión contInua.
C2 TE S1 cement-based adhesive for surfaces subject to continuous immersion.

- 3** 1ª Capa de impermeabilizante.
1st Waterproofing layer.

- 4** Malla impermeabilizante.
Waterproofing mesh.

- 5** 2ª Capa de impermeabilizante.
2nd Waterproofing layer.

- 6** Junta hidroexpansiva.
Hydro-expansive joint.

- 7** Sellado de la junta de dilatación con masilla antiácida, elástica e impermeable.
Expansion joint sealed with an acid-proof, waterproof elastic putty.

- 8** Rejuntado de junta de las baldosas con CG2 W.
CG2 W tile grouting.

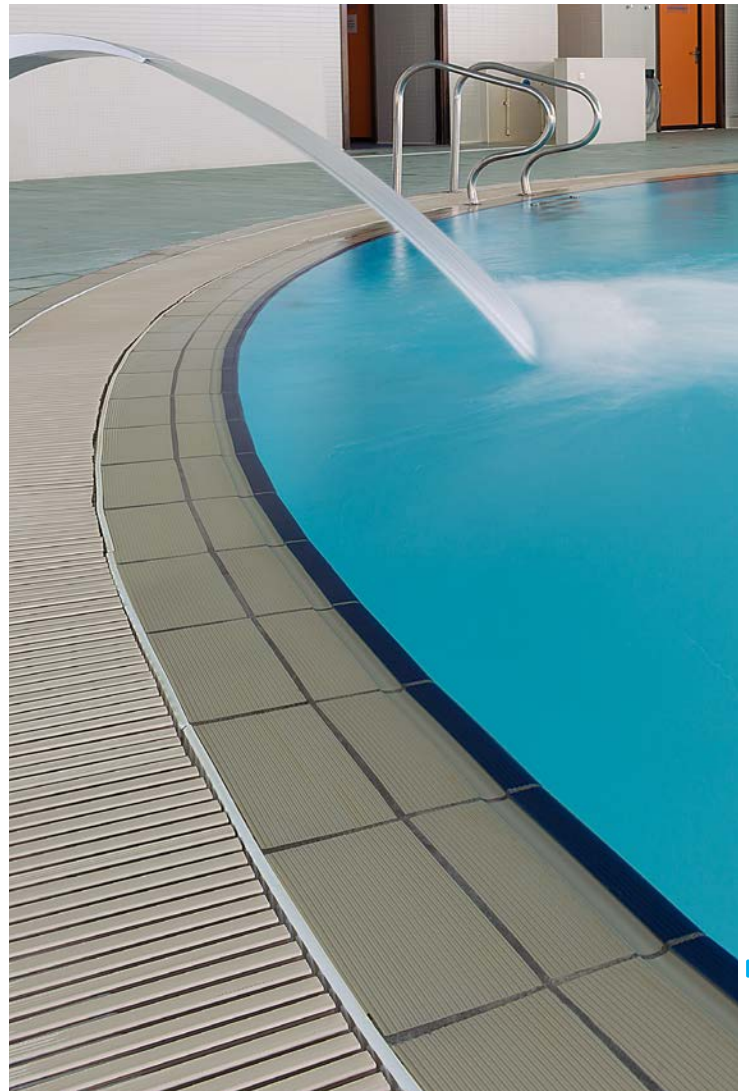
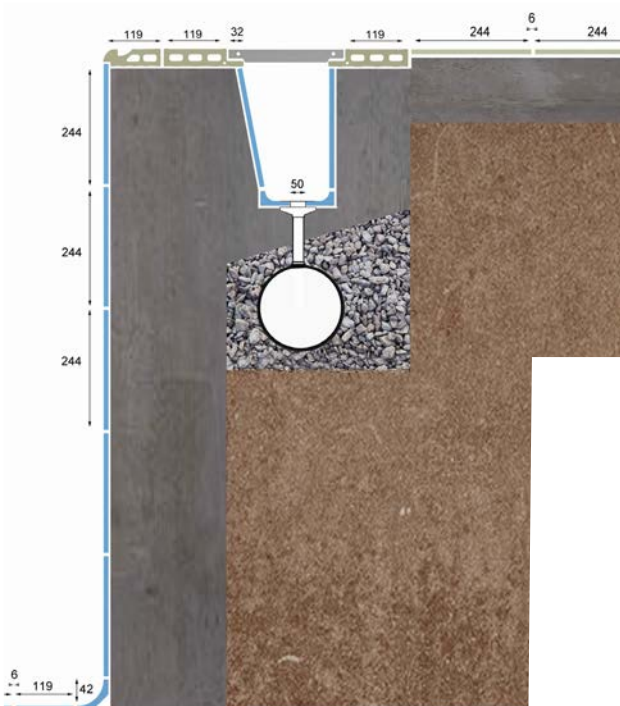

PIEZAS DE HORMIGÓN CONCRETE PIECES

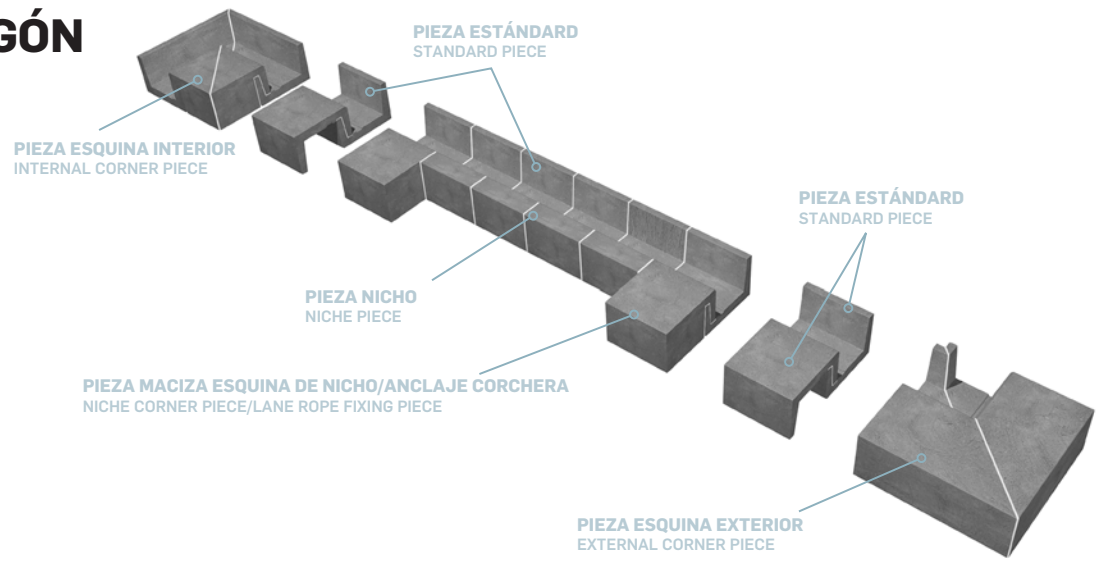

PIEZA ESTÁNDAR
STANDARD PIECE
Cod. 901754 [PZ135]

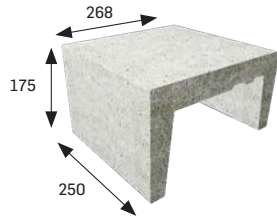

PIEZA MACIZA ESQUINA DE NICHO/ANCLAJE CORCHERA
NICHE CORNER PIECE/LANE ROPE FIXING PIECE
Cod. 901751 [PZ255]

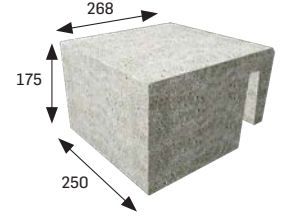

PIEZA NICHO
NICHE PIECE
Cod. 901752 [PZ135]

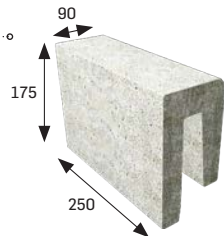

PIEZA ROMA PARA MOSAICO
BLUNT PIECE FOR MOSAIC
Cod. 901753 [PZ135]

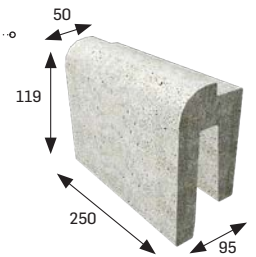

PIEZA ESQUINA INTERIOR
INTERNAL CORNER PIECE
Cod. 901750 [JG745]

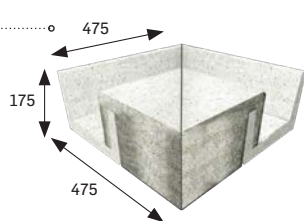

PIEZA ESQUINA EXTERIOR
EXTERNAL CORNER PIECE
Cod. 901749 [JG745]

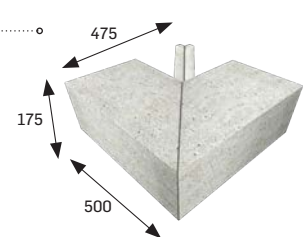

	Espesor (mm) Thickness (mm)	U.M.*	U.M./Caja U.M./Box	U.M./Palet U.M./Pallet	Pzs./U.M. Pcs./U.M.	Pzs./Caja Pcs./Box	Kg./U.M. Kg./U.M.	Kg./Caja Kg./Box	Kg./Palet Kg./Pallet
Pieza estándar Standard piece	15	Pz. Pc.	-	108	1	108	10,16	-	1097
Pieza maciza esquina de nicho/anclaje corchera Niche corner piece/lane rope fixing piece	15	Pz. Pc.	-	24	1	24	25	-	600
Pieza nicho Niche piece	-	Pz. Pc.	-	60	1	60	6,3	-	378
Pieza roma para mosaico Blunt piece for mosaic	-	Pz. Pc.	-	60	1	60	7	-	420
Pieza esquina interior Internal corner piece	-	Kit Kit	-	1	4	4	59	-	59
Pieza esquina exterior External corner piece	-	Kit Kit	-	1	4	4	46	-	46

* Unidad de Medida. Los artículos medidos en m² o ml se sirven contando la junta normal entre piezas.
* Unit of Measure. Items measured in sqm or lm are delivered assuming average joint between pieces.

Colocación paso a paso
Laying phases

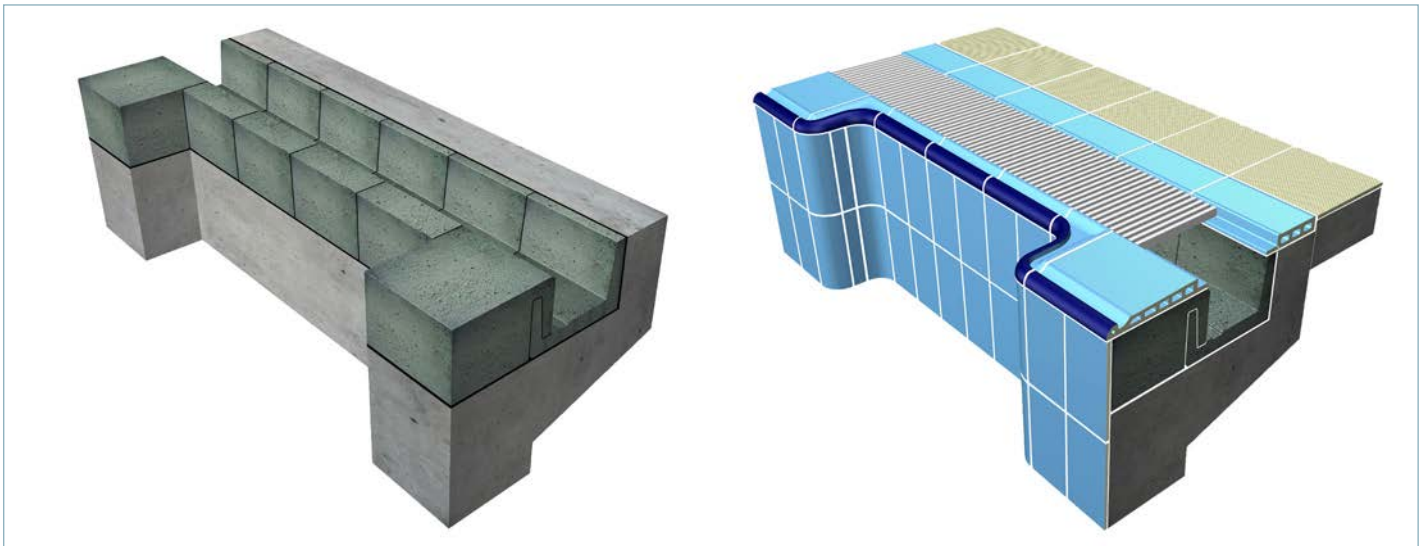
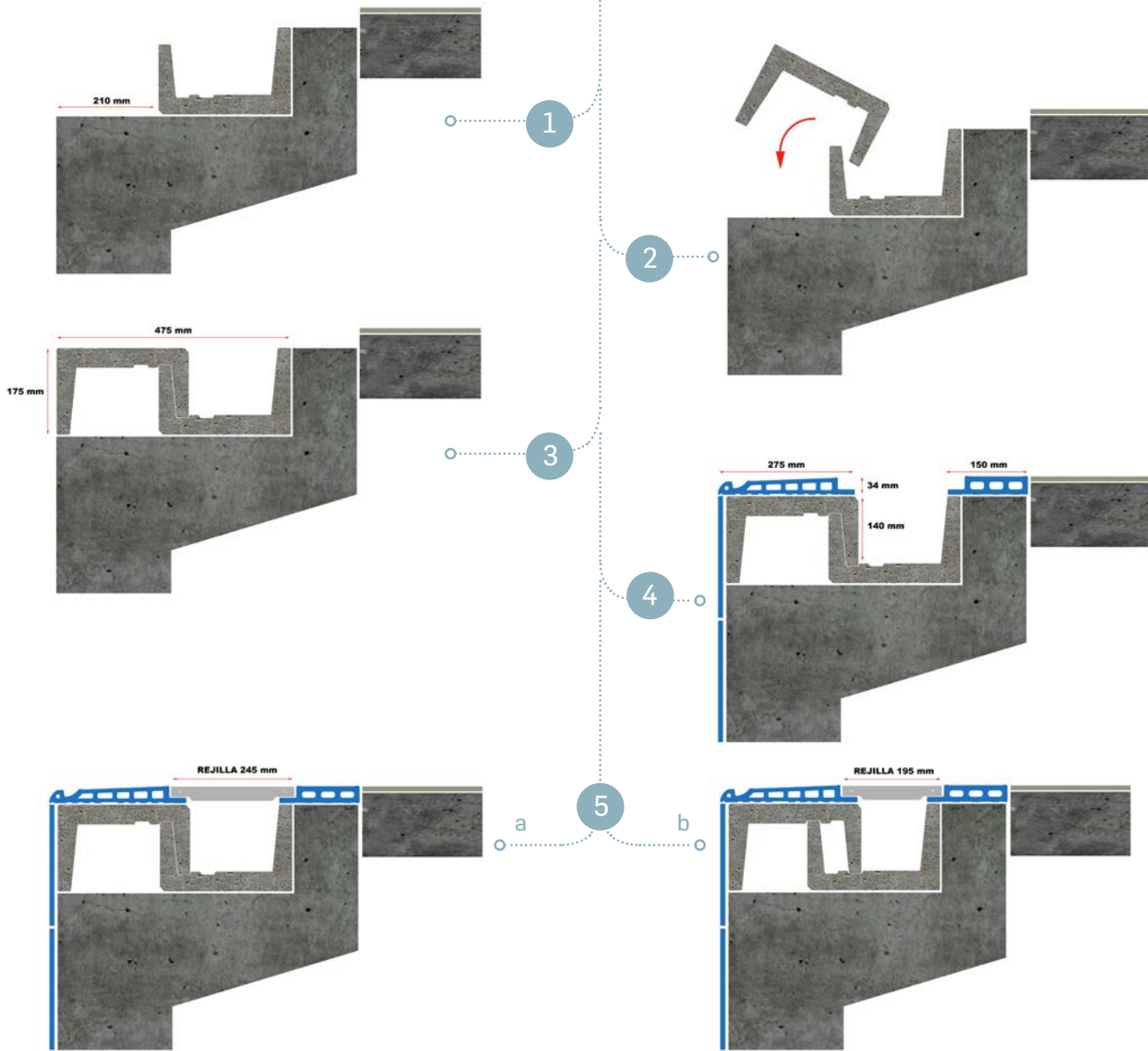

Sistemas de coronación no desbordantes Non-overflow edging systems

KLINKER

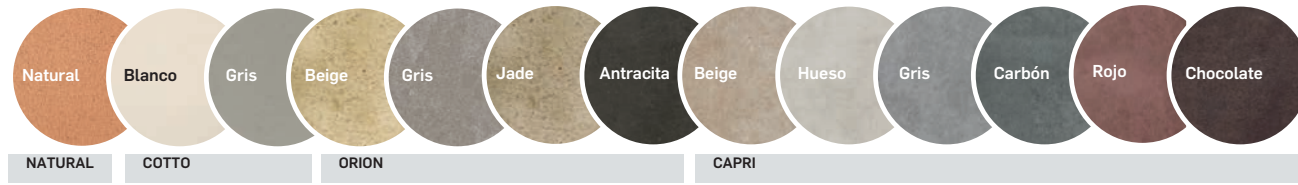

REMATE 33

EDGE 33

[325x275x65x25 mm]

Natural Cod. 900197 [PZ290]

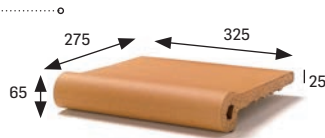

REMATE 10

EDGE 10

[275x103x65x25 mm]

Natural Cod. 900194 [PZ260]

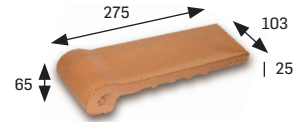

REMATE ESQUINA INTERIOR

INTERNAL CORNER

[325x325x65x24 mm]

Natural Cod. 900184 [PZ525]

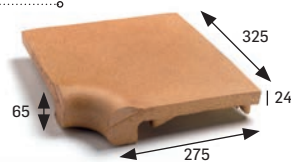

REMATE ESQUINA EXTERIOR

EXTERNAL CORNER

[275x275x65x24 mm]

Natural Cod. 900204 [PZ525]



REMATE

EDGE

[325x270x55x19 mm]

Cotto Blanco Cod. 902767 [PZ335]

Cotto Gris Cod. 902811 [PZ335]

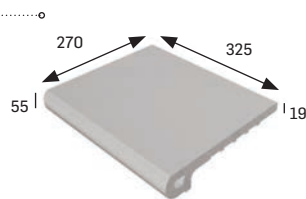

PELDAÑO RECTO 50

STRAIGHT STAIR-TREAD 50

[492x330x18 mm]

Orión Beige Cod. 904493 [PZ355]

Orión Gris Cod. 904482 [PZ355]

Orión Jade Cod. 904489 [PZ355]

Orión Antracita Cod. 904608 [PZ355]

Capri Beige Cod. 905092 [PZ355]

Capri Hueso Cod. 905093 [PZ355]

Capri Gris Cod. 905094 [PZ355]

Capri Carbón Cod. 905095 [PZ355]

Capri Rojo Cod. 905654 [PZ355]

Capri Chocolate Cod. 905147 [PZ355]

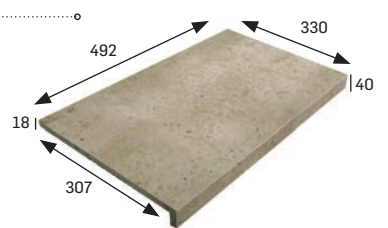

196

PISCINA PÚBLICA RECREATIVA Y PRIVADA PUBLIC RECREATIONAL AND PRIVATE POOL

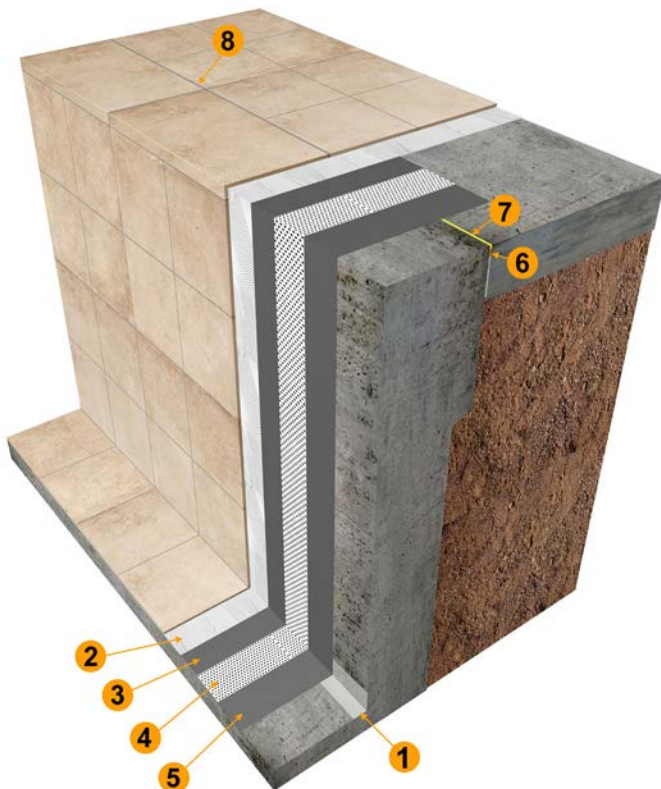

- 1 Banda elástica de impermeabilización.
Elastic waterproofing membrane.
- 2 Cemento cola C2 TE S1, para inmersión contInua.
C2 TE S1 cement-based adhesive for surfaces subject to continuous immersion.
- 3 1ª Capa de impermeabilizante.
1st Waterproofing layer.
- 4 Malla impermeabilizante.
Waterproofing mesh.
- 5 2ª Capa de impermeabilizante.
2nd Waterproofing layer.
- 6 Junta hidroxexpansiva.
Hydro-expansive joint.
- 7 Sellado de la junta de dilatación con masilla antiácida, elástica e impermeable.
Expansion joint sealed with an acid-proof, waterproof elastic putty.
- 8 Rejuntado de junta de las baldosas con CG2 W.
CG2 W tile grouting.

PORCELÁNICO PORCELAIN TILES



PELDAÑO RECTO 30
STRAIGHT STAIR-TREAD 30
Antideslizante · Anti slip
[297x315x14 mm]

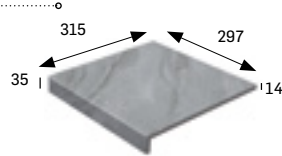

- Tibet Blanco** Cod. 970119 [PZ300]
- Tibet Gris** Cod. 970120 [PZ300]
- Tibet Beige** Cod. 970121 [PZ300]
- Tibet Antracita** Cod. 970122 [PZ300]

PELDAÑO RECTO 60
STRAIGHT STAIR-TREAD 60
Antideslizante · Anti slip
[597x315x14 mm]

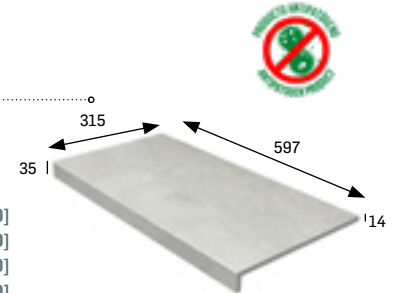

- Urban Blanco** Cod. 970023 [PZ650]
- Urban Gris** Cod. 970024 [PZ650]
- Urban Beige** Cod. 970025 [PZ650]
- Urban Grafito** Cod. 970090 [PZ650]
- Ordesa Gris** Cod. 970064 [PZ650]
- Ordesa Beige** Cod. 970065 [PZ650]
- Ordesa Natural** Cod. 970175 [PZ650]
- Ordesa Marrón** Cod. 970066 [PZ650]

PELDAÑO RECTO 120
STRAIGHT STAIR-TREAD 120
Antideslizante · Anti slip
[1197x315x14 mm]

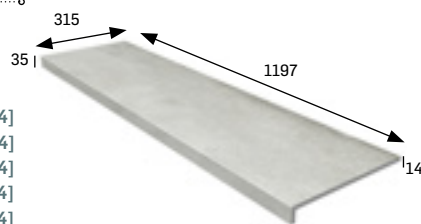

- Urban Blanco** Cod. 970095 [PZ744]
- Urban Gris** Cod. 970096 [PZ744]
- Urban Beige** Cod. 970097 [PZ744]
- Urban Grafito** Cod. 970091 [PZ744]
- Ítaca Gris** Cod. 970099 [PZ744]
- Ítaca Mix** Cod. 970098 [PZ744]
- Ordesa Gris** Cod. 970067 [PZ744]
- Ordesa Beige** Cod. 970068 [PZ744]
- Ordesa Natural** Cod. 970176 [PZ744]
- Ordesa Marrón** Cod. 970069 [PZ744]
- Tibet Blanco** Cod. 970127 [PZ744]
- Tibet Gris** Cod. 970128 [PZ744]
- Tibet Beige** Cod. 970129 [PZ744]
- Tibet Antracita** Cod. 970130 [PZ744]
- Carrara Blanco** Cod. 970178 [PZ744]
- Travertino Beige** Cod. 970181 [PZ744]

ESQUINA RECTA
STRAIGHT STAIR-TREAD CORNER
Antideslizante · Anti slip
[315x315x40x14 mm]

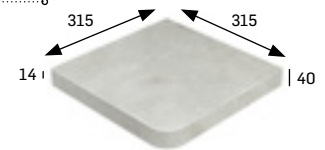

- Tibet Blanco** Cod. 904951 [PZ715]
- Tibet Gris** Cod. 904952 [PZ715]
- Tibet Beige** Cod. 904953 [PZ715]
- Tibet Antracita** Cod. 904954 [PZ715]

	Espesor (mm) Thickness (mm)	U.M.*	U.M./Caja U.M./Box	U.M./Palet U.M./Pallet	Pzs./U.M. Pcs./U.M.	Pzs./Caja Pcs./Box	Kg./U.M. Kg./U.M.	Kg./Caja Kg./Box	Kg./Palet Kg./Pallet
Remate 33 Edge 33	25	Pz. Pc.	4	168	1	4	5	19,8	832
Remate 10 Edge 10	25	Pz. Pc.	12	504	1	12	1,85	22,2	932,4
Remate esq. int. Internal corner	24	Pz. Pc.	2	60	1	2	7,4	14,8	444
Remate esq. ext. External corner	24	Pz. Pc.	2	56	1	2	6,3	12,6	354
Remate Edge	19	Pz. Pc.	4	168	1	4	4,95	19,8	831
Peldaño recto 50 Straight stair-tread 50	18	Pz. Pc.	4	144	1	4	6,33	25,3	911
Peldaño recto 30 Straight stair-tread 30	14	Pz. Pc.	4	288	1	4	2,76	11,05	795,5
Peldaño recto 60 Straight stair-tread 60	14	Pz. Pc.	4	144	1	4	5,8	23,4	842
Peldaño recto 120 Straight stair-tread 120	14	Pz. Pc.	2	32	1	2	11,32	22,6	362,2
Esquina recta Straight stair-tread corner	14	Pz. Pc.	2	60	1	2	3,5	7	420

* Unidad de Medida. Los artículos medidos en m² o ml se sirven contando la junta normal entre piezas.
* Unit of Measure. Items measured in sqm or lm are delivered assuming average joint between pieces.

Anchura recomendada de la junta de colocación: Consultar pág. 15.
Recommended joint width: See pg. 15.

ACCESORIOS PLÁSTICOS

PLASTIC ACCESSORIES

ANGULAR

ANGLE

Blanco / White Cod. 903268 [ML345]

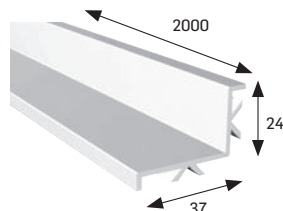

REJILLA RÍGIDA 245 MM

GRATING 245 MM - RIGID

Blanco / White Cod. 903259 [ML555]

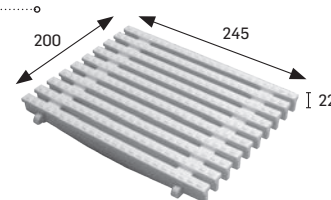

REJILLA RÍGIDA 295 MM

GRATING 295 MM - RIGID

Blanco / White Cod. 903260 [ML575]
Marrón / Brown Cod. 903261 [ML575]

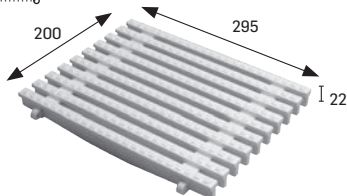

REJILLA CURVA

GRATING BENDABLE

195 mm

Blanco / White Cod. 903262 [ML630]

245 mm

Blanco / White Cod. 903263 [ML670]

295 mm

Blanco / White Cod. 903264 [ML685]

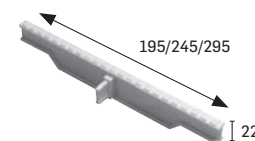

ESQUINA

CORNER

195 mm

Blanco / White Cod. 903265 [PZ730]

245 mm

Blanco / White Cod. 903266 [PZ740]
Gris / Grey Cod. 904554 [*]



REJILLA LONG. RÍGIDA 195 MM

GRATING 195 MM - RIGID LONGITUDINAL

Blanco / White Cod. 900315 [*]

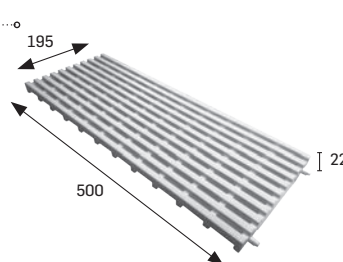

REJILLA LONG. RÍGIDA 245 MM

GRATING 245 MM - RIGID LONGITUDINAL

Blanco / White Cod. 904426 [*]

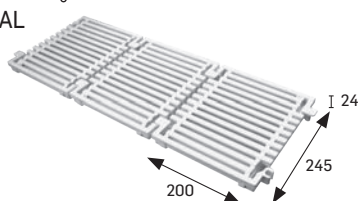

REJILLA TRANS. CURVA TIPO F

F-TYPE GRATING BENDABLE TRANSV.

195 mm

Blanco / White Cod. 904550 [*]

245 mm

Blanco / White Cod. 904551 [*]
Gris / Grey Cod. 904553 [*]

295 mm

Blanco / White Cod. 904552 [*]

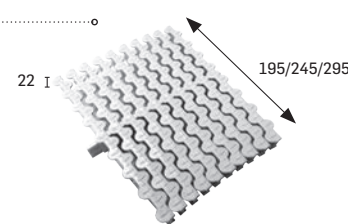

[*] Consultar PVP con fábrica.

[*] Ask the factory for price details.





	U.M.*
Rejilla rígida 245 Grating rigid 245	ML. Lm.
Rejilla rígida 295 Grating rigid 295	ML. Lm.
Angular Angle	ML. Lm.
Rejilla curva 195 Grating bendable 195	ML. Lm.
Rejilla curva 245 Grating bendable 245	ML. Lm.
Rejilla curva 295 Grating bendable 295	ML. Lm.
Esquina 195 Corner 195	Pz. Pc.
Esquina 245 Corner 245	Pz. Pc.
Esquina 295 Corner 295	Pz. Pc.
Rejilla longitudinal 195 Grating rigid longitudinal 195	ML. Lm.
Rejilla longitudinal 245 Grating rigid longitudinal 245	ML. Lm.
Rejilla transversal curva tipo F 195 F-Type Grating 195 - bendable transverse	ML. Lm.
Rejilla transversal curva tipo F 245 F-Type Grating 245 - bendable transverse	ML. Lm.
Rejilla transversal curva tipo F 295 F-Type Grating 295 - bendable transverse	ML. Lm.

Consultar datos de embalaje a fábrica.

Ask the factory for packing details.

* Unidad de Medida. Los artículos medidos en m² o ml se sirven contando la junta normal entre piezas.

* Unit of Measure. Items measured in sqm or lm are delivered assuming average joint between pieces.

Realizaciones Projects

Albania / Albania

Piscina Privada TIMEX SH.P.K. – TIRANE

Alemania / Germany

SANDY GRANITE

Angola / Angola

Piscina en Hotel Resort en Luanda (Angola)

Arabia Saudi / Saudi Arabia

Piscina King Saud University en Arabia Saudí

Piscina centro de damnificados por accidentes en Riyadh

Instalaciones acuáticas del Medical City Centre en Riyadh

Piscinas del Towers B&C en Riyadh, Arabia Saudí

Piscinas de la cadena de gimnasios FITNESSTIME

Bangladesh / Bangladesh

Piscinas del hotel GRAN SULTAN RESORT en Dhaka

Bulgaria / Bulgaria

Complejo FORES GARDEN en CHERNOMORESTS

Cuba / Cuba

Hotel Memories 4* La Habana - Miramar

Hotel Costa Verde Beach Resort 4*, Holguín

Paradisus Río de Oro. Guardalavaca. Holguín

Flamenco 3 y 4, Cayo Sta María

Hotel Ensenacho

Hotel Tryp Peninsula

Hotel Alameda

Hotel Delegación Alмест Occidente

Hotel Melia, Varadero

Hotel AEI Las Conchas

Hotel Los Helechos, Varadero

Hotel UBA, Varadero

Hotel Marina Gaviota

Djibuti / Djibuti

Piscina en Hotel Resort en Djibuti

Emiratos Árabes Unidos / UAE

Piscina Ladies Club Abu Dhabi

España / Spain

Centro Termolúdico de Cascante (Navarra)

Piscina de Zarauz (Vizcaya)

Piscina Hotel Marriott Marbella (Málaga)

Piscina en Linares (Jaen)

Piscinas de Villanueva de Gállego (Cubierta y exteriores)

Centro Deportivo Municipal de Valdefierro (Zaragoza)

Piscina cubierta de Tarazona (Zaragoza)

Piscina Municipal de San Gregorio (Zaragoza)

Piscinas municipales de Illueca (Zaragoza)

Piscina municipal de Alcañiz (Teruel)

Piscina municipal de Albaterra (Alicante)
Piscina municipal cubierta de Ayamonte (Huelva)
Piscina municipal cubierta de Gerena (Sevilla)
Piscina municipal descubierta de 50 m en Almonte (Huelva)
Piscina municipal cubierta de 50 m en Fuengirola (Málaga)
Piscina municipal cubierta en Arroyo de la Miel (Málaga)
Piscina municipal descubierta en Aguadulce (Sevilla)
Piscina municipal descubierta en Pedreras (Sevilla)
Complejo municipal de cuatro piscinas en Arahal (Sevilla)
Piscina municipal cubierta de Alcalá de Guadaíra (Sevilla)
Piscina cubierta del centro de mayores de Aroche (Huelva)
Piscina municipal descubierta de Aznalcazar (Sevilla)
Piscina municipal descubierta de Bonares (Huelva)
Piscina municipal descubierta de El Madroño (Sevilla)
Piscina municipal cubierta de La Carlota (Córdoba)
Piscina municipal cubierta de Cazorla (Jaén)
Complejo deportivo municipal de Ubeda (Jaén)
Piscina municipal de Pradolano - Sierra Nevada (Granada)
Piscina municipal cubierta en Las Gabias (Granada)
Piscina municipal cubierta de Mijas (Málaga)
Piscina municipal descubierta de Montalban (Córdoba)
Piscina municipal de Villanueva del Arzobispo (Jaén)
Piscina del parador nacional de Jaén
Piscina de centro deportivo en Jerez (Cádiz)
Piscina municipal cubierta en barrio de Málaga
Piscina municipal en Higuera de la Sierra (Huelva)
Piscina municipal cubierta en Osuna (Sevilla)
Piscina Balneario de Ariño (Teruel)

Francia / France

Piscine camping "Le Grand Crohot" à Lacanau (à côté de Bordeaux, département 33)
Piscine privée Gilles Esnault (frontière avec Suisse)
Piscine projet (AK2) à côté de Lyon
Piscine privée BH Matériaux (Lauzerte, département 82)

Gran Bretaña / UK

LV School, Ascot
Pickaquoy pool, Orkney
Loughborough University Swimming pool
Holt Park Swimming pool
Chilton Trinity Collage pool
Honnington Military air base
Israel / Israel
Hotel SHERATON – TEL AVIV (piscina zona Infantil)

Italia / Italy

Piscina Club tenis Circolo Parioli (Roma)
Piscina municipal Roma
Piscina Hotel Maggagiari Palermo
Piscina Arma di Taggia Torino
Piscina Sheraton Catania Hotel

Jordania / Jordan

Piscina del Crown Plaza Dead Sea Resort en Jordania

Marruecos / Maroc

Piscina del palacio real de Rabat

Méjico / Mexico

Leyes de Reforma, Veracruz
Unidad Deportiva 20 Noviembre, Campeche
Spot City León, León
Sport City Cuautitlán, Cuautitlán Izcalli
Sport City Gran Sur, Tlalpan, DF
Sport City Guadalajara
Sport City Santa Fe, Cuajimalpa, DF
Sport City Pachuca, Pachuca, Hgo.
Centro de Alto Rendimiento (CAR), Iztacalco, DF
Instituto Cumbres Bosques, Cuajimalpa, DF
Colegio Americano de Torreón, Torreón, Coah
Acuática Nelson Vargas San Jerónimo, Magdalena Contreras, DF
Acuática Nelson Vargas Satélite, Naucalpan, Edo Mexico
Sport City LindaVista, Gustavo A Madero, DF
Sport City Coacalco, Coacalco, DF
Acuática Nelson Vargas Del Valle, Benito Juárez, DF
Centro de Alto Rendimiento Tijuana
Centro Acuático CEFORMA, Tlalpan, DF
Colegio Everest Chihuahua, Chihuahua
Centro Acuático Pantitlan, Iztacalco, DF
Acuática Nelson Vargas, Aguascalientes
Club Campestre de Chihuahua, Chihuahua
Alberca Tricentenario, Chihuahua, Chi
Unidad Querétaro 2000, Querétaro, Qro
Club de Golf Altozano Morelia, Morelia,
Club de Golf Altozano Colima, Colima, Col
Centro Acuático Panamericanos, Guadalajara
Centro Acuático Reynosa, Reynosa, Tamps
Sport City Loreto, Magdalena Contreras, DF
Sport City Samara, Cuajimalpa, DF
Club de Golf Campestre de Leon, Leon, Gato
Ymca Ejercito nacional, Miguel Hidalgo, Df
Ymca Morelos, Iztapalapa, DF
Centro Acuático Morelia, Morelia
Club Seven Days, Morelia
Colegio de Magdalena, Michuca

Nigeria / Nigeria

Piscina particular GOBERNADOR – Compañía Interventora

Portugal / Portugal

Piscina municipal de Viseu
Piscina municipal de Odemira
Piscina municipal de Vila Franca de Xira
Piscina de Termas da Fadagosa
Piscina de Spa m Alferrerede - Abrantes
Piscina municipal de Sto Tirso
Piscina de Lar de Idosos em Fatima
Elvas
Olivais – Lisboa
Sao Vicente da Beira – Castelo Branco
Senegal / Senegal
Piscine du Lycée Francais à Dakar
Piscine municipal de Dakar

Siria / Syria

Piscina y espacio acuático en el Tartous Resort Hotel en Tartous

OBJETIVO DEL TRATAMIENTO:

Las bacterias son microorganismos que se encuentran y reproducen en nuestro entorno y en el interior de los seres vivos.

Nuestra finalidad es ofrecer al cliente un producto antibacteriano, que le proteja de la vulnerabilidad a las reacciones por una contaminación de microorganismos en zonas industriales, restaurantes, playas de piscinas, vestuarios, hospitales, ambulatorios, centros de rehabilitación y tercera edad.

El estudio y objetivo de Gres Aragón ha sido obtener un pavimento vítreo con propiedades bactericidas y fungicidas, que no requieran la incidencia de radiación UV y por lo tanto se puedan utilizar tanto en exteriores como interiores y fachadas, con luz natural, artificial y en plena oscuridad.

COMO FUNCIONA:

La tecnología aplicada inhibe el crecimiento de bacterias, hongos y levaduras, obteniendo a su vez, un producto eficaz contra olores y manchas. Este sistema crea una sinergia fuerte entre ambos materiales dando eficiencia y durabilidad.

El tratamiento se aplica en su proceso de fabricación antes de cocción. Esta composición reacciona en la cocción del pavimento sin alterar sus características ni tonos.

Para ello se emplean componentes de arcillas purificadas y modificadas como transportadores de compuestos antimicrobianos.

El componente principal es la plata, siendo un agente antimicrobiano de amplio espectro y multiespecífico, cuya actividad ha sido probada frente a gran variedad de microorganismos (bacterias y hongos) oportunistas y patógenos como son E. coli, Legionella sp, Pseudomonas, Salmonella, S. aureus, etc.

Esta composición con propiedad oligodinámica ejerce una acción sobre los microorganismos impidiendo su crecimiento y eliminándolos. (Efecto antibacteriano)

ENSAYOS DE EFECTIVIDAD ANTIMICROBIANA:

La actividad antimicrobiana se evalúa mediante el protocolo estándar sobre efectividad antimicrobiana de superficies. Norma JIS Z-2801:2010 (ISO 22196)

Esta norma determina la actividad y eficacia antimicrobiana de productos antimicrobianos en superficies utilizando dos bacterias: Staphylococcus aureus y Escherichia coli.

La actividad antimicrobiana se determina comparando los resultados obtenidos entre la muestra tratada y la muestra control, después del tiempo de contacto determinado (24 horas a una temperatura óptima para el crecimiento del microorganismo seleccionado) y posterior cultivo. De esta forma, se obtendrá el valor de la actividad antimicrobiana.

La norma indica el parámetro R, índice de eficacia bactericida, que debe ser superior a $R > 2$ para considerar que la superficie es bactericida lo que equivale a una reducción del 99% de las bacterias.

PURPOSE OF THE TREATMENT:

Bacteria are microorganisms that inhabit and breed inside living beings and in the environments in which we live.

We aspire to offer customers an antibacterial product that protects them from possible reactions to contamination by microorganisms in industrial areas, restaurants, poolside areas, dressing rooms, hospitals, health and rehabilitation centres and old people's homes.

Gres Aragón has striven to develop an antibacterial, anti-fungal vitreous flooring that requires no ultra-violet ray treatment which can therefore be used both indoors and outdoors also façades, with natural or artificial light or in total darkness.

HOW IT WORKS:

The applied technology inhibits the growth of bacteria, fungi and yeast, while also ensuring odour and stain resistant protection. Strong synergies are generated between both materials, ensuring efficiency and durability.

The treatment is applied during the manufacturing process, prior to firing. The formulation reacts when the floor tiles are fired, without altering their properties or colors in any way.

For this purpose, components of purified modified clays are used to transport the antimicrobial compounds.

The main component that is used is silver: a multi-specific broad-spectrum microbial agent of proven efficacy against a wide variety of opportunistic microorganisms and pathogens (bacteria and fungi), such as E. coli, Legionella sp, Pseudomonas, Salmonella, and S. aureus.

This oligodynamic formulation acts on microorganisms, preventing their growth and eliminating them. (Antibacterial effect).

ANTIMICROBIAL TESTS:

Antimicrobial activity is assessed using the standard test of the efficacy of surface-bound antibacterial products. The JIS Z-2801:2010 standard (ISO 22196).

This standard determines the antimicrobial activity and efficacy of surface-bound anti-microbial products, using two bacteria: Staphylococcus aureus and Escherichia coli.

Antimicrobial activity is determined by comparing the results of a treated sample and control sample after a specific contact period (24 hours at an optimum temperature for the growth of the chosen microorganism) and their subsequent incubation. In this way, a value for antimicrobial activity is obtained.

The standard indicates the necessary R parameter, the indicator of antibacterial efficacy. This must be higher than $R > 2$ for the surface to be deemed to have antibacterial properties. This is equivalent to a 99% reduction in bacteria.

Tratamiento antibacteriano

Antibacterial treatment

- ✓ Solución integrada para conseguir un nivel mayor de higiene.
 - ✓ Aditivos basados en tecnología de última generación.
 - ✓ Protección duradera de superficies.
 - ✓ Alta efectividad contra organismo patógenos oportunistas implicados en enfermedades adquiridas/hospitalarias.
 - ✓ Diferenciación y producto de valor añadido.
-
- ✓ A global solution aimed at guaranteeing greater hygiene levels.
 - ✓ Additives developed using cutting-edge technology.
 - ✓ Long-lasting protection of surfaces.
 - ✓ Highly effective against opportunistic pathogens caused by acquired or hospital-borne illnesses.
 - ✓ Differentiation and value-added product.



Según norma ISO 22196:2011 nuestra gama Aciker tiene un índice de eficacia bactericida $R > 2$, que equivale a una reducción del 99% de las bacterias.

According to ISO 22196: 2011 our Aciker range has a bactericidal efficacy index $R > 2$, which is equivalent to a 99% reduction in bacteria.

ACIKER PLUS

PAVIMENTO INDUSTRIAL INDUSTRIAL FLOOR



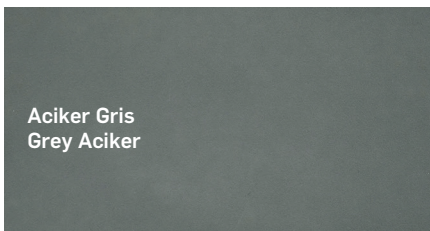
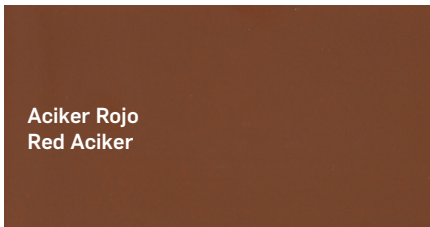
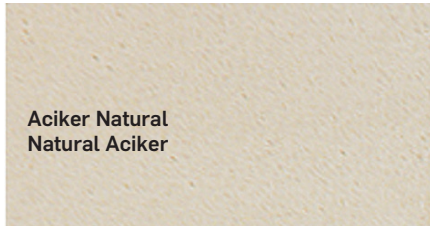





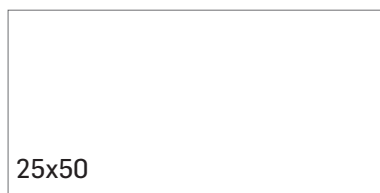
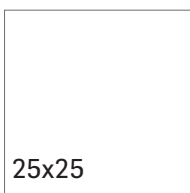
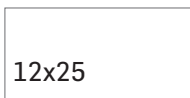







Colores / Colors



Los colores son indicativos.
Colors are just indicative.

(cm) Formatos / Sizes



 PORCELÁNICO PORCELAIN	
 ESMALTADO GLAZED	
 Características dimensionales Dimension tolerance	<1% / <0,6% máx 2 mm
 Absorción de agua Water absorption	E≤0,5%
 Coef. Dilatación termica lineal Linear thermal expansion coefficient	5,8x10 ⁻⁶ xC ⁻¹
 Resistencia a la flexión Breaking Strength	>43 N/mm ²
 Resistencia a la abrasión superficial Resistance to surface abrasion	Rojo/Gris PEI 2 Natural PEI 4
 Resistencia a las manchas Resistance to stains	clase 5 class 5
 Péndulo (CTE) Not required out of Spain	clase 3 class 3
 A pie descalzo Barefoot slip resistance	C
 A pie calzado Slip resistance with footwear	Liso R10 Ranurado R11 Celdillas R12
 Coefficiente fricción dinámico (DCOF) Dynamic coefficient of friction	0,82
 Resistencia al cuarteo Crazing resistance	sí/yes
 Resistencia a la helada Frost resistance	✓
 Resistencia al choque térmico Resistance to thermal shock	✓
 Resistencia química Chemical resistance	✓
 Antibacteriano Antibacterian	R>2 Reducción antibacteriana >99 %



ACIKER PLUS

BASES
BASE TILES



BASE 12x25 TILE 12x25

[244x119x8 mm]

Aciker Natural mate Matt natural Aciker Cod. 904021 [MC420]
Aciker Rojo mate Matt red Aciker Cod. 904003 [MC615]
Aciker Gris mate Matt grey Aciker Cod. 904000 [MC505]

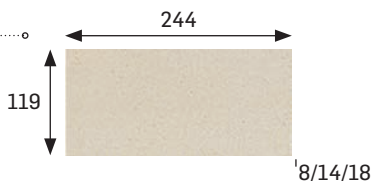

[244x119x14 mm]

Aciker Natural mate Matt natural Aciker Cod. 905774 [MC565]
Aciker Rojo mate Matt red Aciker Cod. 905660 [MC680]
Aciker Gris mate Matt grey Aciker Cod. 905479 [MC643]

[244x119x18 mm]

Aciker Natural mate Matt natural Aciker Cod. 901867 [MC690]

BASE 25x25 TILE 25x25

[244x244x8 mm]

Aciker Natural mate Matt natural Aciker Cod. 905333 [MC420]
Aciker Rojo mate Matt red Aciker Cod. 905334 [MC628]
Aciker Gris mate Matt Grey Aciker Cod. 905335 [MC515]

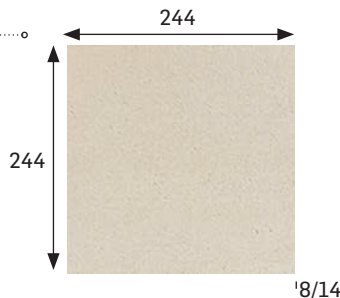

[244x244x14 mm]

Aciker Natural mate Matt natural Aciker Cod. 905351 [MC565]

BASE 25x50 TILE 25x50

[244x494x8,5 mm]

Aciker Natural mate Matt natural Aciker Cod. 904501 [MC453]
Aciker Gris mate Matt Grey Aciker Cod. 904502 [MC501]

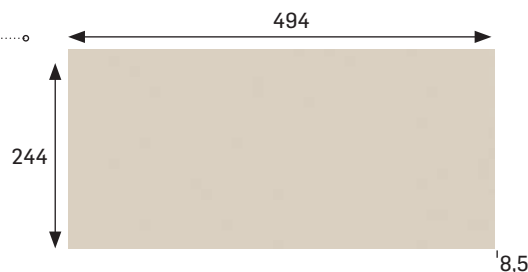

	Espeor (mm) Thickness (mm)	U.M.*	U.M./Caja U.M./Box	U.M./Palet U.M./Pallet	Pzs./U.M. Pcs./U.M.	Pzs./Caja Pcs./Box	Kg./U.M. Kg./U.M.	Kg./Caja Kg./Box	Kg./Palet Kg./Pallet
Aciker 12x25 8 mm	8	m ² sqm	1,06	85	32	34	16,37	17,4	1392
Aciker 12x25 14 mm	14	m ² sqm	0,59	47,5	32	19	29,02	17,2	1378
Aciker 12x25 18 mm	18	m ² sqm	0,47	37,5	32	15	38,7	17,6	1411
Aciker 25x25 8 mm	8	m ² sqm	0,56	67,5	16	9	17,6	9,52	1189
Aciker 25x25 14 mm	14	m ² sqm	0,5	40	16	8	27,2	13,6	1088
Aciker 25x50 Tile 25x50	8,5	m ² sqm	1	56	8	8	19,63	19,63	1080
Celdillas 12x25 8 mm Cell 12x25 8,5 mm	8	m ² sqm	1,06	85	32	34	16,37	17,4	1392
Celdillas 12x25 14 mm Cell 12x25 14 mm	14	m ² sqm	0,59	47,5	32	19	29,02	17,2	1378
Celdillas 25x25 8 mm Cell 25x25 8,5 mm	8	m ² sqm	0,56	67,5	16	9	17,6	9,52	1189
Celdillas 25x25 14 mm Cell 25x25 14 mm	14	m ² sqm	0,5	40	16	8	27,2	13,6	1088
Ranurado 12x25 Grooved 12x25	8	m ² sqm	1,06	85	32	34	16,37	17,4	1392

* Unidad de Medida. Los artículos medidos en m² o ml se sirven contando la junta normal entre piezas.
 * Unit of Measure. Items measured in sqm or lm are delivered assuming average joint between pieces.

Anchura recomendada de la junta de colocación: 6 mm
 Recommended joint width: 6 mm

CELDILLAS
CELL TEXTURES

CELDILLAS 12x25 CELLS 12x25

[244x119x8 mm]

Aciker Natural Natural Aciker	Cod. 905346	[MC493]
Aciker Rojo mate Matt red Aciker	Cod. 905347	[MC630]
Aciker Gris mate Matt grey Aciker	Cod. 905348	[MC553]

[244x119x14 mm]

Aciker Natural mate Matt natural Aciker	Cod. 905773	[MC620]
--	-------------	---------

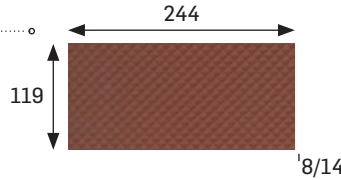

CELDILLAS 25x25 CELLS 25x25

[244x244x8 mm]

Aciker Natural mate Matt natural Aciker	Cod. 905336	[MC501]
Aciker Rojo mate Matt red Aciker	Cod. 905337	[MC630]
Aciker Gris mate Matt grey Aciker	Cod. 905338	[MC553]

[244x244x14 mm]

Aciker Natural mate Matt natural Aciker	Cod. 905512	[MC620]
--	-------------	---------

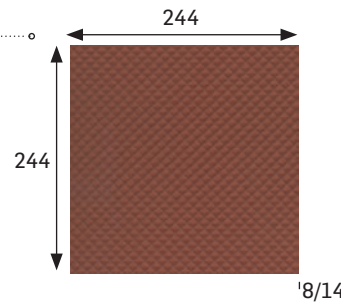

RANURADOS
GROOVED TILES

RANURADO 12X25 GROOVED 12X25

[244x119x8 mm]

Aciker Natural mate Matt natural Aciker	Cod. 905545	[MC560]
Aciker Gris mate Matt grey Aciker	Cod. 905350	[MC583]

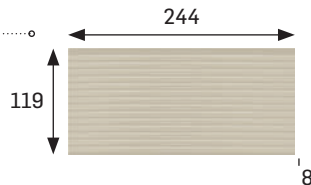

BRILLO
GLOSSY

BASE 12x25 TILE 12x25

[244x119x8 mm]

Aciker Natural brillo Glossy natural Aciker	Cod. 904002	[MC405]
Aciker Gris brillo Glossy grey Aciker	Cod. 904001	[MC437]

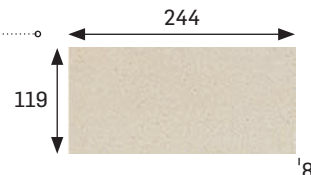

ACIKER PLUS

Aciker Natural
Natural Aciker

Aciker Rojo
Red Aciker

Aciker Gris
Grey Aciker



Laboratorio industrial
Industry laboratory

208

PAVIMENTO INDUSTRIAL INDUSTRIAL FLOOR TILES

	Espesor (mm) Thickness (mm)	U.M.*	U.M./Caja U.M./Box	U.M./Palet U.M./Pallet	Pzs./U.M. Pcs./U.M.	Pzs./Caja Pcs./Box	Kg./U.M. Kg./U.M.	Kg./Caja Kg./Box	Kg./Palet Kg./Pallet
Rinconera Internal radial angle	8,5	Pz. Pc.	32	2304	1	32	0,33	10,56	760,32
Cantonera External radial angle	8,5	Pz. Pc.	40	2880	1	40	0,29	11,60	835,20
Escocia rinconera interior Round internal mitre	-	Pz. Pc.	24	-	1	24	0,1	1,9	-
Escocia cantonera exterior Round external mitre	-	Pz. Pc.	24	-	1	24	0,1	1,9	-
Esq. int. rinconera Internal mitre	-	Pz. Pc.	4	-	1	4	0,33	1,3	-
Esq. ext. cantonera External mitre	-	Pz. Pc.	4	-	1	4	0,33	1,3	-
Esq. int. canto romo Bullnose int. corner	9,5	Pz. Pc.	4	-	1	4	0,48	1,9	-
Esq. ext. canto romo Bullnose ext. corner	9,5	Pz. Pc.	4	-	1	4	0,25	1	-
Canto romo Bullnose	9,5	Pz. Pc.	27	1944	1	27	0,57	15,39	1108

* Unidad de Medida. Los artículos medidos en m² o ml se sirven contando la junta normal entre piezas.
* Unit of Measure. Items measured in sqm or lm are delivered assuming average joint between pieces.

Anchura recomendada de la junta de colocación: 6 mm
Recommended joint width: 6 mm

RINCONERA
INTERNAL RADIAL ANGLE
[244x42 mm]

- Aciker Natural mate**
Matt natural Aciker Cod. 903255 [PZ085]
- Aciker Rojo mate**
Matt red Aciker Cod. 903808 [PZ085]
- Aciker Gris mate**
Matt grey Aciker Cod. 903632 [PZ085]

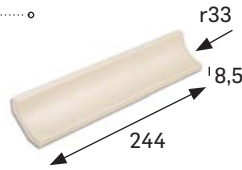

CANTONERA
EXTERNAL RADIAL ANGLE
[244x42 mm]

- Aciker Natural mate**
Matt natural Aciker Cod. 903256 [PZ090]
- Aciker Rojo mate**
Matt red Aciker Cod. 903812 [PZ090]
- Aciker Gris mate**
Matt grey Aciker Cod. 903631 [PZ090]

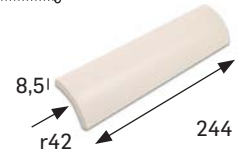

ESCOCIA RINCONERA INTERIOR
ROUND INTERNAL MITRE

- Aciker Natural mate**
Matt natural Aciker Cod. 905606 [PZ270]
- Aciker Rojo mate**
Matt red Aciker Cod. 905548 [PZ280]
- Aciker Gris mate**
Matt grey Aciker Cod. 905611 [PZ270]



ESCOCIA CANTONERA EXTERIOR
ROUND EXTERNAL MITRE

- Aciker Natural mate**
Matt natural Aciker Cod. 905620 [PZ270]
- Aciker Rojo mate**
Matt red Aciker Cod. 905509 [PZ280]
- Aciker Gris mate**
Matt grey Aciker Cod. 905625 [PZ270]



ESQUINA INTERIOR RINCONERA
INTERNAL MITRE
[75x75 mm]

- Aciker Natural mate**
Matt natural Aciker Cod. 905725 [PZ320]
- Aciker Rojo mate**
Matt red Aciker Cod. 905731 [PZ335]
- Aciker Gris mate**
Matt grey Aciker Cod. 905730 [PZ335]

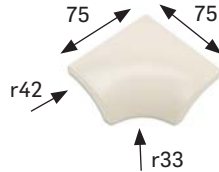

ESQUINA EXTERIOR CANTONERA
EXTERNAL MITRE
[75x75 mm]

- Aciker Natural mate**
Matt natural Aciker Cod. 905740 [PZ320]
- Aciker Rojo mate**
Matt red Aciker Cod. 905746 [PZ335]
- Aciker Gris mate**
Matt grey Aciker Cod. 905745 [PZ335]

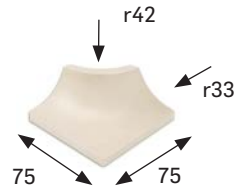

ESQ. INT. CANTO ROMO
BULLNOSE INT. CORNER
[168x168x9,5 mm]

- Aciker Natural mate**
Matt natural Aciker Cod. 905755 [PZ330]
- Aciker Rojo mate**
Matt red Aciker Cod. 905785 [PZ350]
- Aciker Gris mate**
Matt grey Aciker Cod. 905760 [PZ350]

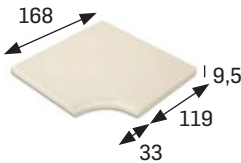

ESQ. EXT. CANTO ROMO
BULLNOSE EXTERNAL CORNER
[119x119x9,5 mm]

- Aciker Natural mate**
Matt natural Aciker Cod. 905762 [PZ330]
- Aciker Rojo mate**
Matt red Aciker Cod. 905786 [PZ350]
- Aciker Gris mate**
Matt grey Aciker Cod. 905767 [PZ350]



CANTO ROMO
BULLNOSE
[244x119x9,5 mm]

- Aciker Natural mate**
Matt natural Aciker Cod. 900687 [PZ123]
- Aciker Rojo mate**
Matt red Aciker Cod. 903823 [PZ123]
- Aciker Gris mate**
Matt grey Aciker Cod. 901711 [PZ123]

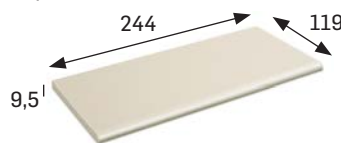

ACIKER PLUS

Aciker Natural
Natural Aciker

Aciker Rojo
Red Aciker

Aciker Gris
Grey Aciker



Instalación industrial
Industrial facility

210

PAVIMENTO INDUSTRIAL INDUSTRIAL FLOOR TILES

	Espesor (mm) Thickness (mm)	U.M.*	U.M./Caja U.M./Box	U.M./Palet U.M./Pallet	Pzs./U.M. Pcs./U.M.	Pzs./Caja Pcs./Box	Kg./U.M. Kg./U.M.	Kg./Caja Kg./Box	Kg./Palet Kg./Pallet
Ángulo desigual Angle different sides	-	Pz. Pc.	8	576	1	8	0,97	7,7	559
Rodapié radio 33 Skirting board radius 33	8,5	Pz. Pc.	10	720	1	10	0,86	8,6	619
Canaleta ranurada Drainage overflow channel	-	Pz. Pc.	4	72	1	4	2,10	8,4	620
Canaleta Overflow channel	-	Pz. Pc.	11	704	1	11	1,32	14,5	930
Final de Canaleta End channel piece	-	Pz. Pc.	**	-	1	**	1,32	**	-
Canaleta desagüe Drainage overflow channel	-	Pz. Pc.	11	-	1	11	1,3	14,5	-
Esquina interior rodapié Interior skirting board angle	8,5	Pz. Pc.	6	-	1	6	0,16	0,96	-
Esquina exterior rodapié Exterior skirting board edging	8,5	Pz. Pc.	4	-	1	4	0,24	0,96	-

* Unidad de Medida. Los artículos medidos en m² o ml se sirven contando la junta normal entre piezas.
* Unit of Measure. Items measured in sqm or lm are delivered assuming average joint between pieces.

** Consultar datos de embalaje con fábrica.
** Ask the factory for packing information.

ANGULO DESIGUAL
ANGLE DIFFERENT SIDES

[244x119x39,2 mm]

Aciker Natural mate

Matt natural Aciker Cod. 905722 [PZ210]

Aciker Rojo mate

Matt red Aciker Cod. 905723 [PZ235]

Aciker Gris mate

Matt grey Aciker Cod. 905724 [PZ235]

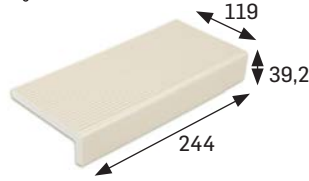

RODAPIÉ RADIO 33
SKIRTING BOARD RADIUS 33

[244x120x42 x8,5 mm]

Aciker Natural mate

Matt natural Aciker Cod. 903254 [PZ080]

Aciker Rojo mate

Matt red Aciker Cod. 901740 [PZ135]

Aciker Gris mate

Matt grey Aciker Cod. 902477 [PZ135]



CANALETA RANURADA
GROOVED CHANNEL*

[244x244 mm]

Aciker Natural mate

Matt natural Aciker Cod. 901986 [PZ340]

Aciker Rojo mate

Matt red Aciker Cod. 903806 [PZ355]

Aciker Gris mate

Matt grey Aciker Cod. 903807 [PZ355]



CANALETA
OVERFLOW CHANNEL

[244x150mm]

Aciker Natural mate

Matt natural Aciker Cod. 900659 [PZ290]

Aciker Rojo mate

Matt red Aciker Cod. 903339 [PZ290]

Aciker Gris mate

Matt grey Aciker Cod. 903340 [PZ290]



* Disponible Canaleta con desagüe.

* Available Overflow channel with drainage.

FINAL DE CANALETA
END CHANNEL PIECE**

[244x150 mm]

Aciker Natural mate

Matt natural Aciker Cod. 903640 [PZ375]

Aciker Rojo mate

Matt red Aciker Cod. 903637 [PZ455]

Aciker Gris mate

Matt grey Aciker Cod. 903636 [PZ420]



CANALETA CON DESAGÜE
DRAINAGE OVERFLOW CHANNEL

[244x150 mm]

Aciker Natural mate

Matt natural Aciker Cod. 900660 [PZ355]

Aciker Rojo mate

Matt red Aciker Cod. 903343 [PZ355]

Aciker Gris mate

Matt grey Aciker Cod. 903344 [PZ355]

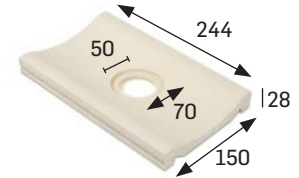

ESQUINA INTERIOR RODAPIÉ
SKIRTING BOARD ANGLE

[120x8,5 mm]

Aciker Natural mate

Matt natural Aciker Cod. 903257 [PZ350]

Aciker Rojo mate

Matt red Aciker Cod. 903810 [PZ355]

Aciker Gris mate

Matt grey Aciker Cod. 902479 [PZ355]

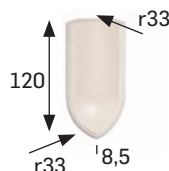

ESQUINA EXTERIOR RODAPIÉ
SKIRTING BOARD EDGING

[120x75mm]

Aciker Natural mate

Matt natural Aciker Cod. 903258 [PZ350]

Aciker Rojo mate

Matt red Aciker Cod. 903814 [PZ355]

Aciker Gris mate

Matt grey Aciker Cod. 902478 [PZ355]

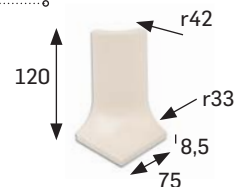

Área Contract Contract Area

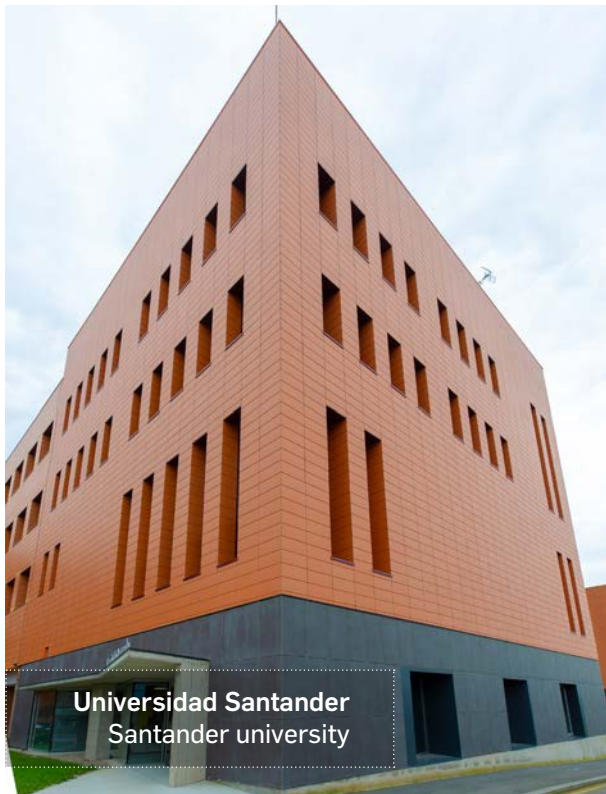

Universidad Santander
Santander university



Edificio residencial Trento Max
Trento Max residential building

Desde nuestra Área Contract se trabajan las líneas técnicas de producto GRES ARAGON (piscina, industria, proyectos singulares) y las soluciones para fachadas ventiladas y sate cerámico de FAVEKER.

El área da soporte técnico a despachos de arquitectura, ingenierías, instaladores, aplicadores y, en general, a todas aquellas partes implicadas en una óptima solución arquitectónica. Dependiendo de las necesidades del proyecto aportamos propuesta de soluciones, cálculos y justificaciones técnicas, planos, así como el contacto con expertos en materias de interés. Asimismo, trabajamos en el desarrollo de nuevos productos, soluciones y aplicaciones de materiales cerámicos y/o compuestos.

Bajo la premisa de ayudar a obtener siempre una perfecta ejecución de proyectos, aportamos nuestra experiencia mediante también actividades formativas para la prescripción, clientes y profesionales del sector.

From our Contract Department, we work on the technical ranges of GRES ARAGON product (swimming pool, industry, singular projects) and the solutions for ventilated façades and ceramic sate of FAVEKER.

The area provides technical support to architects, engineering, installers, building workers and, in general, to all parties involved in an optimal architectural solution. Depending on the needs of the project we propose solutions, calculations and technical justifications and plans, as well as the contact with experts in matters of interest. We also work on the development of new products, solutions and applications of ceramic and/or composite materials.

Under the premise of helping to always obtain a perfect execution of projects, we come up with our experience with formative activities for the prescription, clients and sector professionals.

Faveker 6R sustainability concept



Reciclable y reciclado

Materiales sostenibles, 100% reciclables y con un contenido mínimo en reciclados en su composición del 40%. Propulsamos economías circulares.

Recyclable and recycled

Sustainable materials, 100% recyclable and with at least 40% of recycled content. We promote circular economies.



Respeto por el medio ambiente

El carácter reciclable, el contenido de reciclados, la reducción de emisiones gracias a la disminución de demanda de energía, hacen a nuestros materiales respetuosos con el medio ambiente.

Respect for the environment

The recyclable nature, the recycled content, the reduction of emissions thanks to the energy-demand lowering, make our materials be environmentally friendly.



Resistencia

Piezas porcelánicas fabricadas por extrusión con luces entre apoyos de hasta 1.200 mm.

Resistance

Porcelain tiles manufactured by extrusion with spans between supports of at least 1.200 mm.



Rehabilitación

Disponemos de alturas y largos de pieza estándar que permiten modular rehabilitaciones, mejorando el aspecto exterior y las prestaciones energéticas de los edificios.

Refurbishment

We offer heights and lengths for standard pieces that are suitable to modulate refurbishments, improving the external look and the energy performance of the buildings.



Reducción de consumos y emisiones

El aumento de aislamiento que aporta el sistema permite un importante ahorro en la demanda primaria de energía del edificio.

Reduction of consumption and emissions

The increase of insulation that it gives to the systems allows an important primary energy saving for the building.



Reducción agentes patógenos

Gracias al tratamiento Bioklinker®, se añaden propiedades anti patógenas a las fachadas ventiladas de FAVEKER®, ayudando a la sanitización de espacios.

Reduction of pathogens

Thanks to the Bioklinker® treatment, antipathogen properties are added to Faveker® ventilated façades, helping to sanitize the place.

Fachada ventilada cerámica / Ceramic ventilated façade

01.

Durabilidad y resistencia:

sin cambio en sus propiedades, un material que perdura en el tiempo sin verse afectado por los agentes climáticos (humedad, viento, radiación solar...).

Durability and resistance:

without change in its properties, a material that lasts over time without being affected by climatic factors (humidity, wind, solar radiation...).

02.

Posibilidades estéticas:

gracias a la avanzada tecnología de decoración en el sector cerámico, con las aplicaciones de impresión digital, se pueden conseguir infinidad de acabados de máxima calidad y durabilidad.

Aesthetic possibilities:

thanks to the advanced decoration technology in the ceramic sector, including those with digital printing, you can get many finishes of the highest quality and durability.

03.

Aumento de aislamiento,

tanto térmico como acústico dado que protege al aislante, pudiéndose utilizar materiales más específicos que no resistirían a la intemperie.

Increase in insulation,

both thermal and acoustic since it protects the insulator, being able to use more specific materials that would not resist to the elements.

04.

Ligero y limpio:

material cerámico ligero en comparación con otros materiales comúnmente utilizados y de fácil mantenimiento.

Light and clean:

light ceramic material compared to other commonly used and easy maintenance materials.

05.

Eficiente y sostenible:

sistemas de alta eficiencia energética por el ahorro en energía y respetuosos con el medio ambiente por su composición y proceso productivo

Efficient and sustainable:

systems of a high energy efficiency being energy saving and environmentally friendly due to its composition and production process.

Las principales ventajas de los sistemas de FAVEKER® aúnan las ventajas de los sistemas de fachada ventilada cerámica y ofrecen además prestaciones adicionales:

The main advantages of FAVEKER® systems combine the advantages of ceramic ventilated façade systems and also offer additional benefits:

Sistemas de anclaje oculto, con solape de la junta horizontal, permitiendo así la transpirabilidad pero protegiendo contra la humedad y el agua.

Concealed anchoring systems, with horizontal joint overlap, thus allowing breathability but protecting against moisture and water.

Disponemos de varios espesores, desde los ligeros 18 mm hasta los espesados de 30 mm.

We have several thicknesses, from the light 18 mm to the thick ones of 30 mm.

Las placas son fabricadas por extrusión y tienen una estructura interna alveolar que ofrece resistencia y ligereza.

The plates are manufactured by extrusion and have an internal cellular structure that offers resistance and lightness.

Sistemas registrables: la mayoría de los sistemas permiten ser desmontados para poder realizar reparaciones en la piel o detrás de la piel de la fachada sin romper piezas ni desmontar grandes paños. Simplemente se retira la pieza o piezas deseadas y se colocan de nuevo.

Registered systems: most systems can be disassembled to perform repairs on the skin or behind the skin of the façade without breaking pieces or disassembling large cloths. Simply remove the desired piece or pieces and put them back on.

Están fabricadas con arcillas porcelánicas ofreciendo absorciones de agua igual o inferiores al 0,5%.

They are manufactured with porcelain clays offering water absorption equal to or less than 0.5%.

Sistemas sostenibles por definición: utilizamos hasta un 40% de reciclados en la fabricación de las piezas cerámicas y las piezas pueden ser 100% recicladas (tanto los subproductos del proceso como, a futuro, las propias piezas cerámicas). Comprometidos con el medio ambiente, Gres Aragón fue la primera empresa española en obtener un doble reconocimiento europeo (Global EPD y ECOPlatform) de su DAP certificada por AENOR.

Sustainable systems by definition: we use up to 40% recycled in the manufacture of ceramic pieces and the pieces can be 100% recycled (both the by-products of the process and the own ceramic pieces in the future). Committed to the environment, Gres Aragón was the first Spanish company to obtain a double European recognition (Global EPD and ECOPlatform) of its DAP certified by AENOR.

En resumen, los sistemas de envolvente térmica mediante fachada ventilada cerámica FAVEKER® aportan al proyecto AHORRO, EFICIENCIA ENERGÉTICA, SOSTENIBILIDAD, CONFORT, HABITABILIDAD, ESTÉTICA, RESISTENCIA Y DURABILIDAD.

In summary, the FAVEKER® ceramic ventilated façade thermal envelope systems contribute to the SAVINGS, ENERGY EFFICIENCY, SUSTAINABILITY, COMFORT, HABITABILITY, AESTHETIC, RESISTANCE AND DURABILITY projects.

GA16

Formato / Format

Longitud hasta 1800 mm
Length up to 1800 mm
Peso/ weight 31,7 Kg/m²

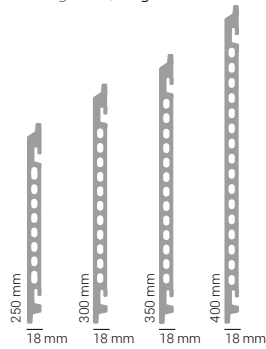

Sistema de fijación / Fixing system

FTS 502 A



FTS 502 B



Descripción / Description

Modelo muy versátil, especialmente orientado a la protección de la cámara ventilada y, que por su diseño, permite optimizar el peso y los portes.

Versatile product, specially oriented toward protecting the ventilated chamber and, which thanks to its design, results in freight and building structure cost savings.

Características principales Main features

- Porcelánico
- Solape junta horizontal
- 2 lados rectificados
- Anclaje oculto
- Registrable
- Porcelain
- Overlap
- 2 rectified sides
- Hidden fixings
- Accessible chamber after installation

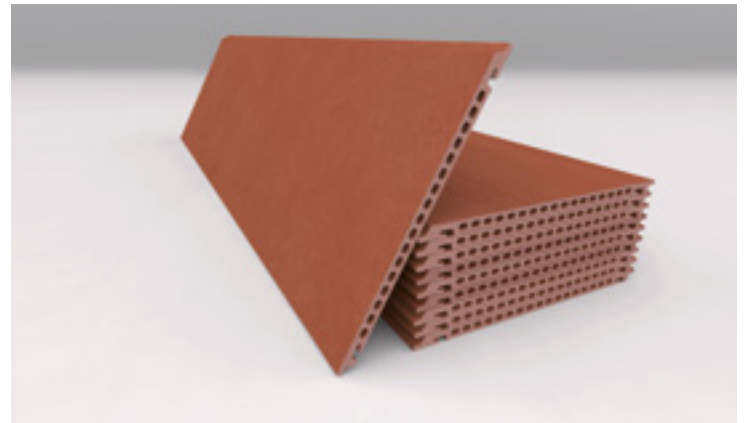

Gama de colores / Color range

Basic

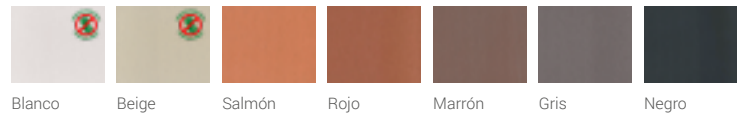

Glazed

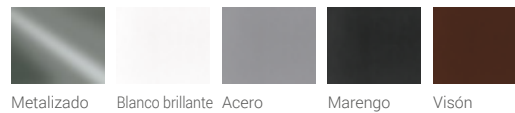

Inkjet

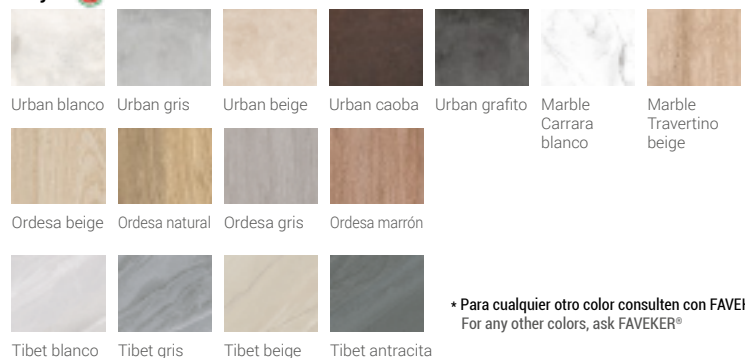

* Para cualquier otro color consulten con FAVEKER® / For any other colors, ask FAVEKER®

GA20

Características principales Main features

- Porcelánico
- 4 lados rectificados
- Anclaje oculto
- Permite colocación vertical
- Porcelain
- 4 rectified sides
- Hidden fixings
- Allow vertical fixing

Sistema de fijación / Fixing system

FTS 502 B

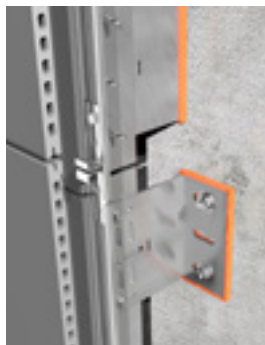

FTS 502 B Vertical



FTS 506

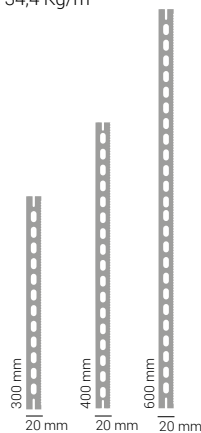
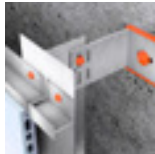

Descripción / Description

Modelo que transmite la precisión con la que es fabricada cada una de sus piezas a la vez que favorece las posibilidades estéticas del edificio.

Product that conveys the accuracy with which the tiles are produced and that increases the design possibilities of the building.

Formato / Format

Longitud 800, 1000, 1200 y hasta 1800 mm
Length 800, 1000, 1200 and up to 1800 mm
Peso/ weight 34,4 Kg/m²

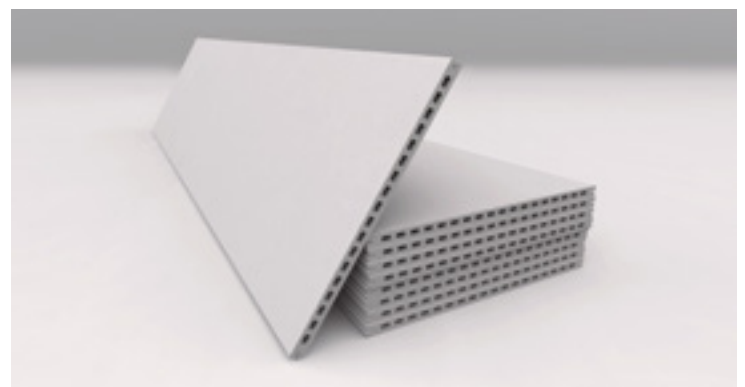

Gama de colores / Color range

Basic

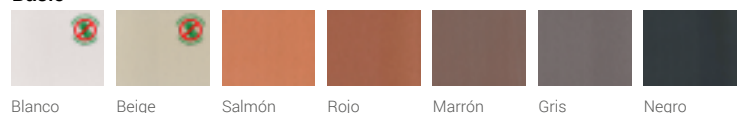

Inkjet

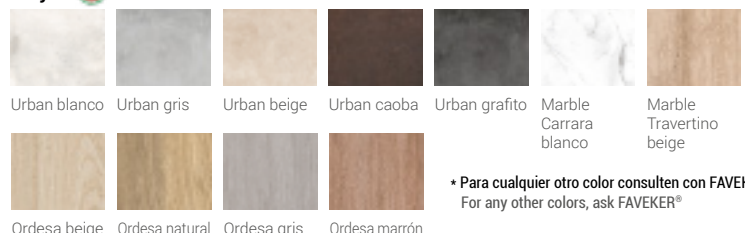

* Para cualquier otro color consulten con FAVEKER® / For any other colors, ask FAVEKER®

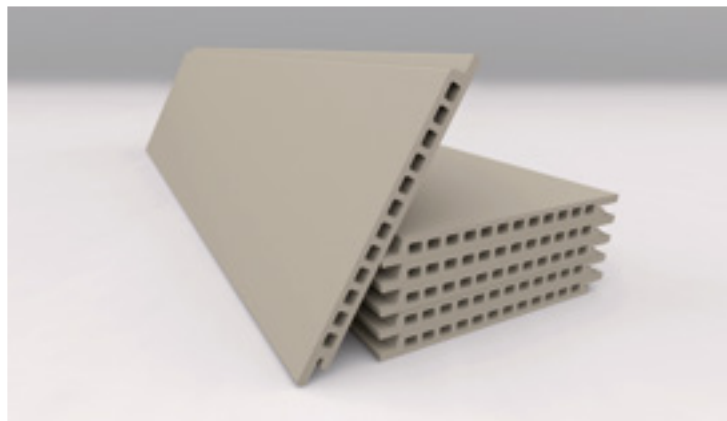

Descripción / Description

GA30 acentúa las lagas horizontales ofreciendo una estética más lineal.

GA30 emphasizes the horizontal jointing giving an intense lineal look to the façade.

Características principales / Main features

- Porcelánico
- Solape junta horizontal
- 2 lados rectificadados
- Anclaje oculto
- Máxima resistencia
- Porcelain
- Overlap
- 2 rectified sides
- Hidden fixings
- Maximum strength

GA30

Formato / Format

Longitud 800, 1000, 1200 y hasta 1800 mm
Length 800, 1000, 1200 and up to 1800 mm
Peso/ weight 45 Kg/m²

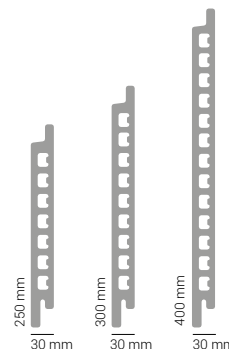

Gama de colores / Color range

Basic

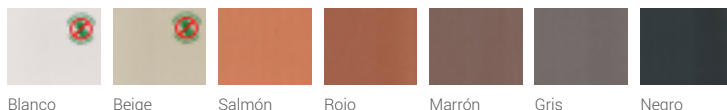

Glazed



Inkjet

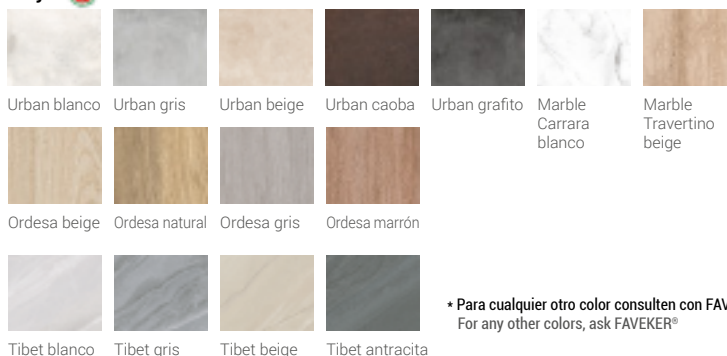

* Para cualquier otro color consulten con FAVEKER® / For any other colors, ask FAVEKER®

Sistema de fijación / Fixing system

FTS 502 B

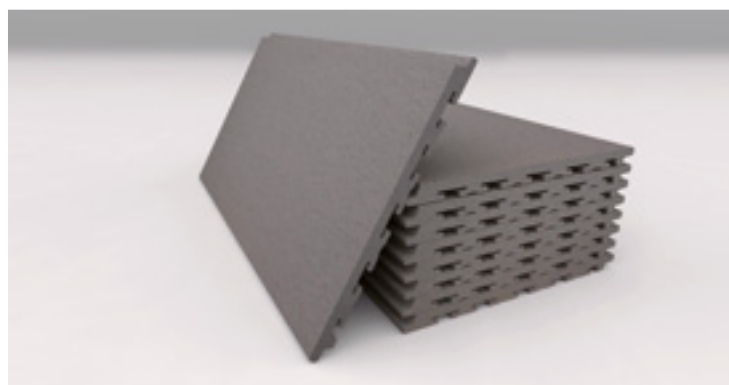

Características principales / Main features

- Terracotta
- Solape junta horizontal
- Anclaje oculto
- Multi anclaje con facil ajuste longitudinal
- Terracotta
- Overlap
- Hidden fixings
- Multiple fixing, easy longitudinal adjustment

GAV

Formato / Format

Longitud/ length 600 mm
Peso/ weight 36 Kg/m²



Gama de colores / Color range

Basic

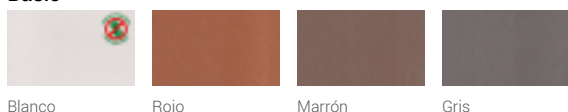

Inkjet

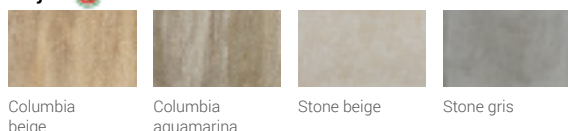

* Para cualquier otro color consulten con FAVEKER® / For any other colors, ask FAVEKER®

Sistema de fijación / Fixing system

FTS 502 A

FTS 502 B



Realizaciones Projects

PAVIMENTOS FLOOR TILES
PORCELÁNICOS PORCELAIN TILES

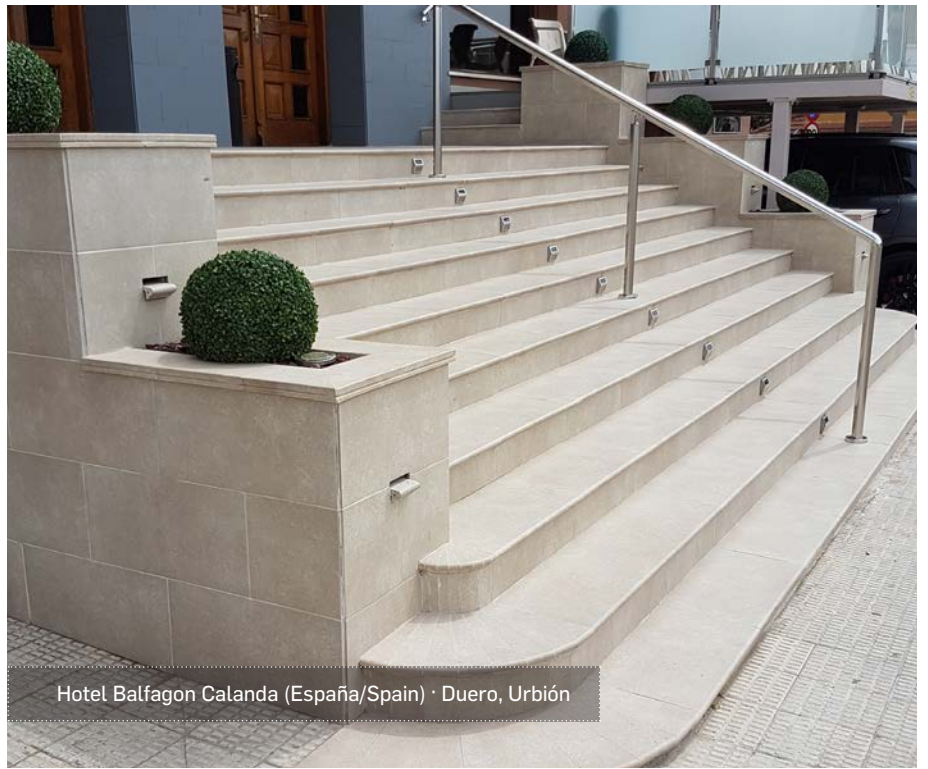

Hotel Balfagon Calanda (España/Spain) · Duero, Urbión

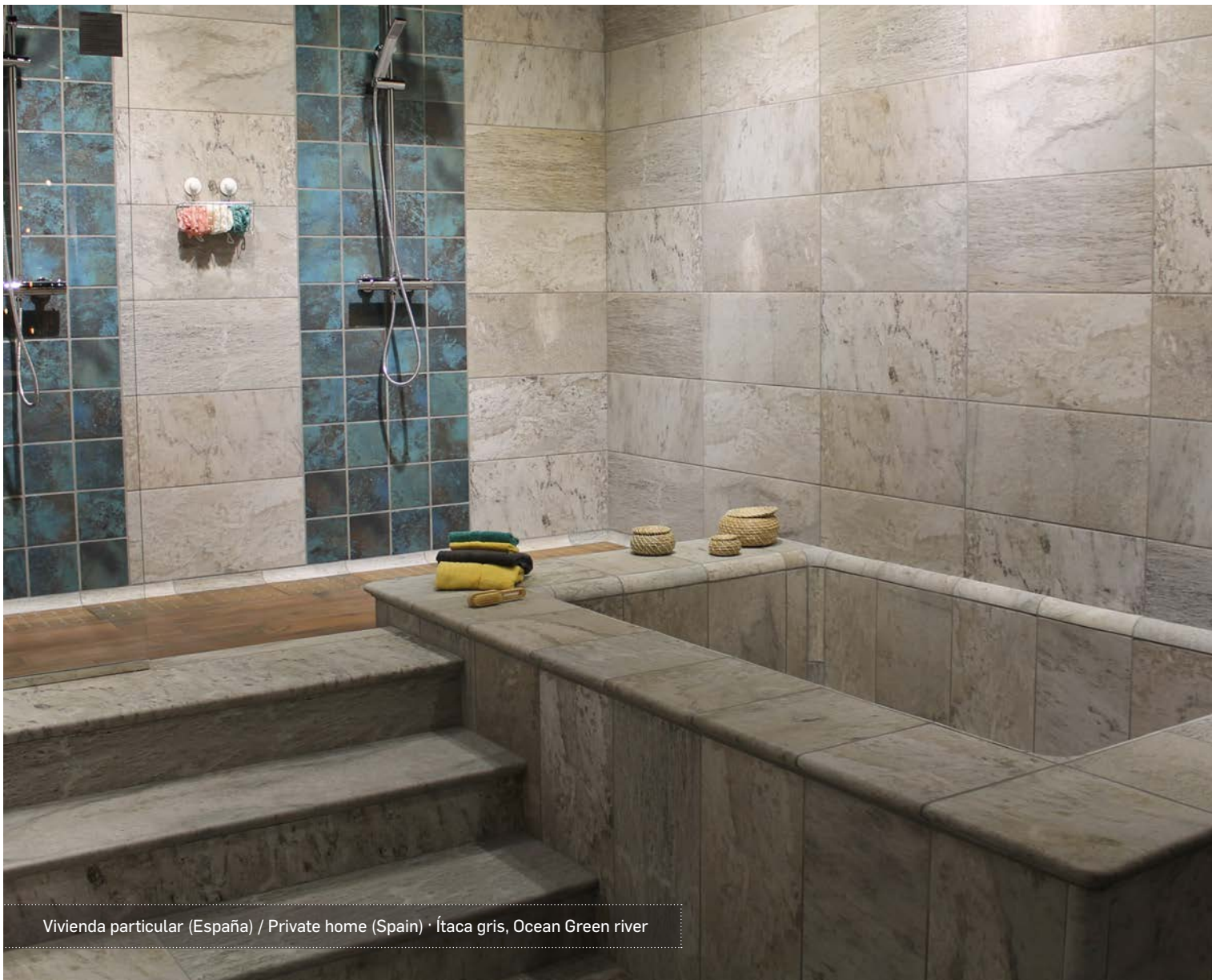

Vivienda particular (España) / Private home (Spain) · Ítaca gris, Ocean Green river

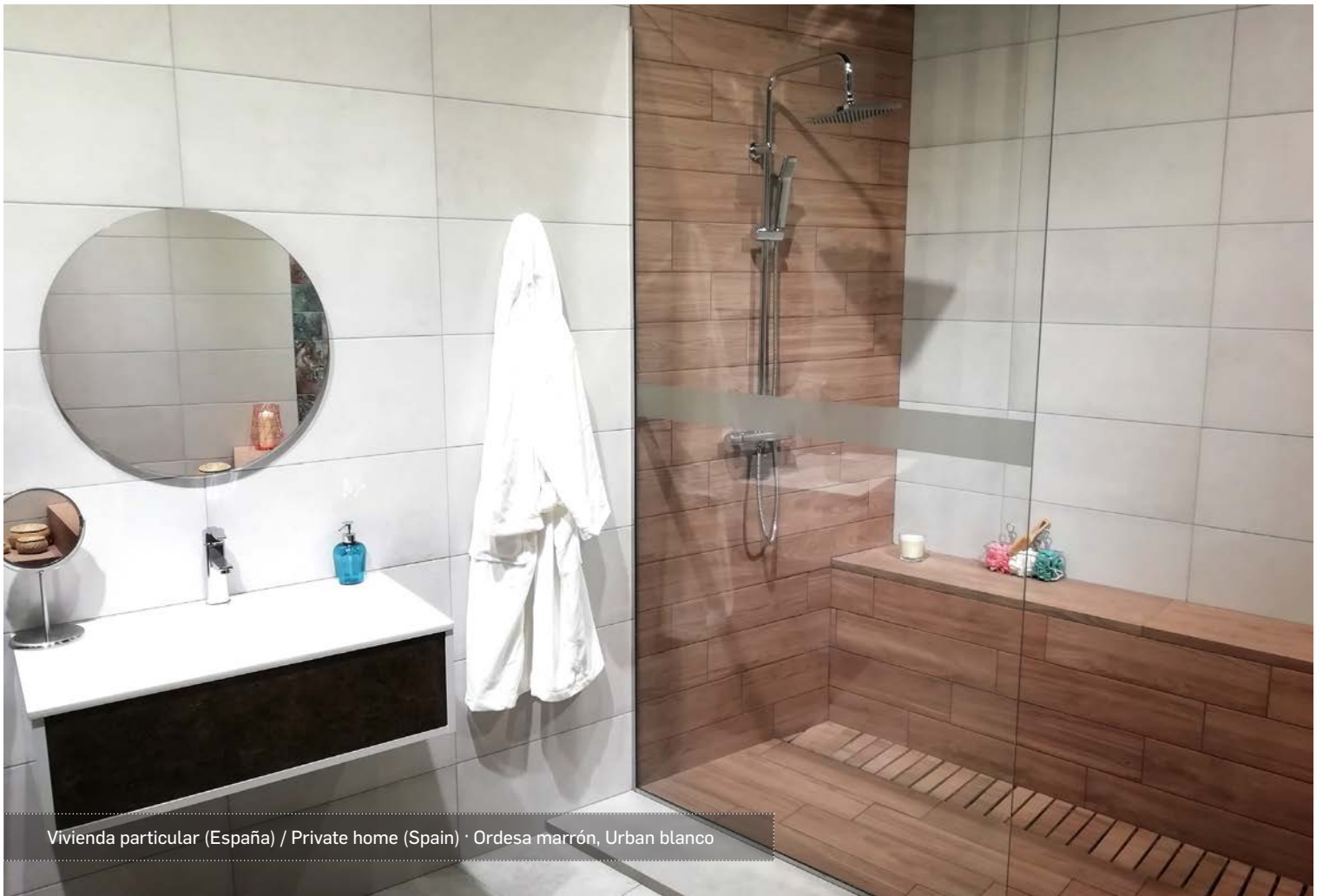

Vivienda particular (España) / Private home (Spain) · Ordesa marrón, Urban blanco

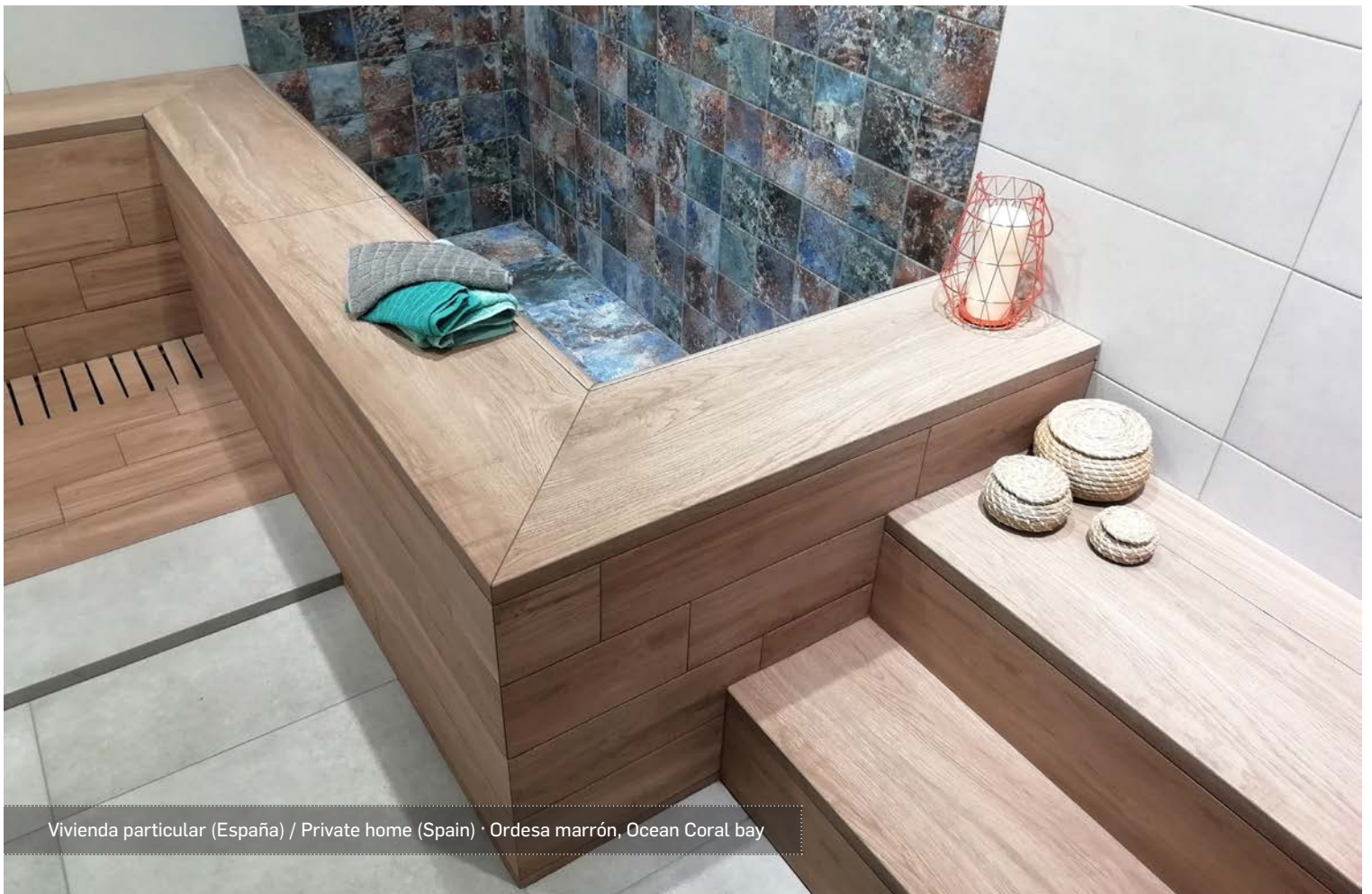

Vivienda particular (España) / Private home (Spain) · Ordesa marrón, Ocean Coral bay

Realizaciones Projects

PAVIMENTOS FLOOR TILES
PORCELÁNICOS PORCELAIN TILES



Piscina privada / Private pool (Brunei) · Urban gris



Piscina privada / Private pool (Brunei) · Rocks gris

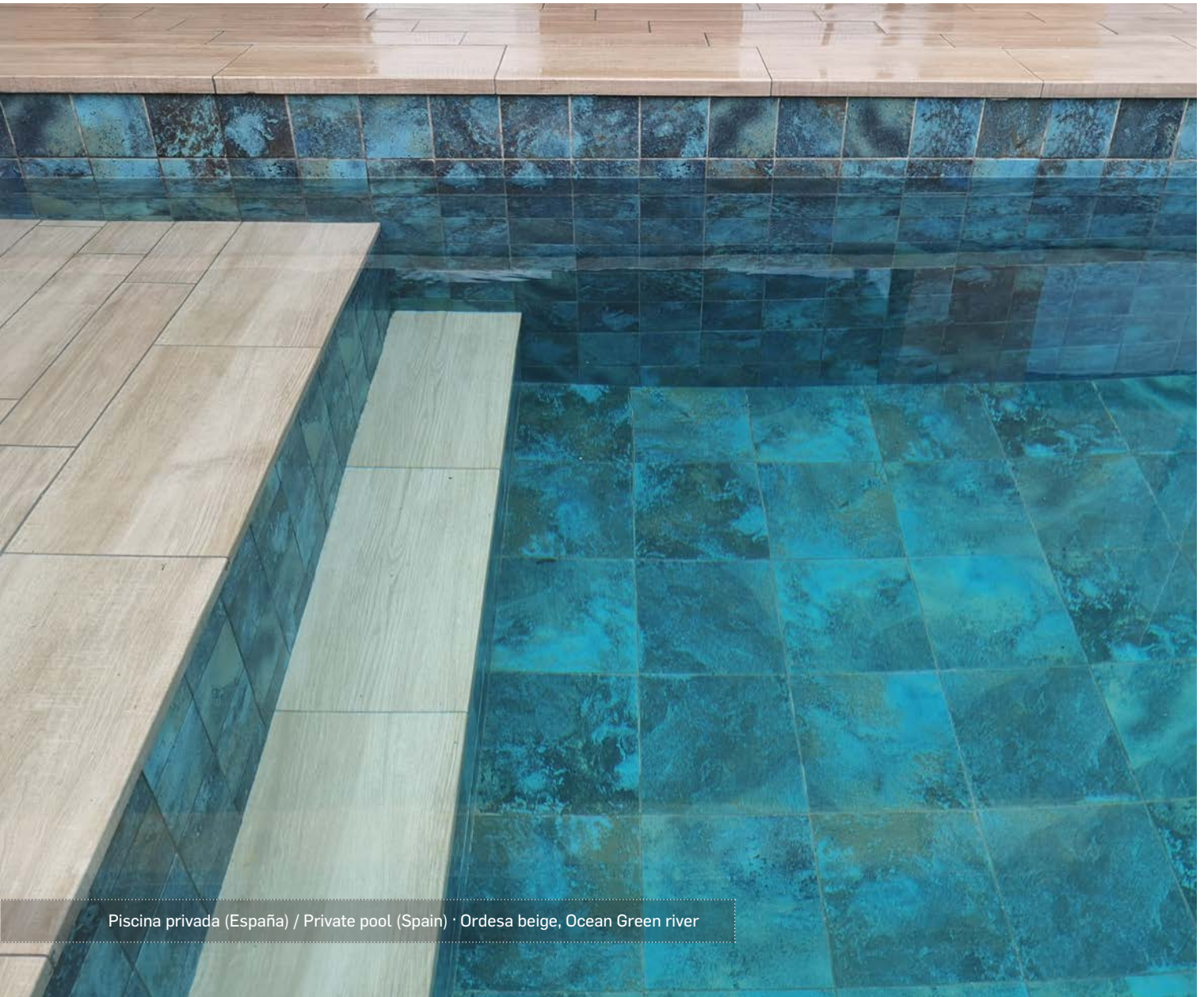

Piscina privada (España) / Private pool (Spain) · Ordesa beige, Ocean Green river



Realizaciones Projects

PAVIMENTOS FLOOR TILES
NATURALES NATURAL TILES

Vivienda particular (España) / Private home (Spain) · Natural



Hotel Eurosol (Portugal) · Natural

Realizaciones
Projects
ACEPOOL
WELLNESS CERAMICS-GRES ARAGON

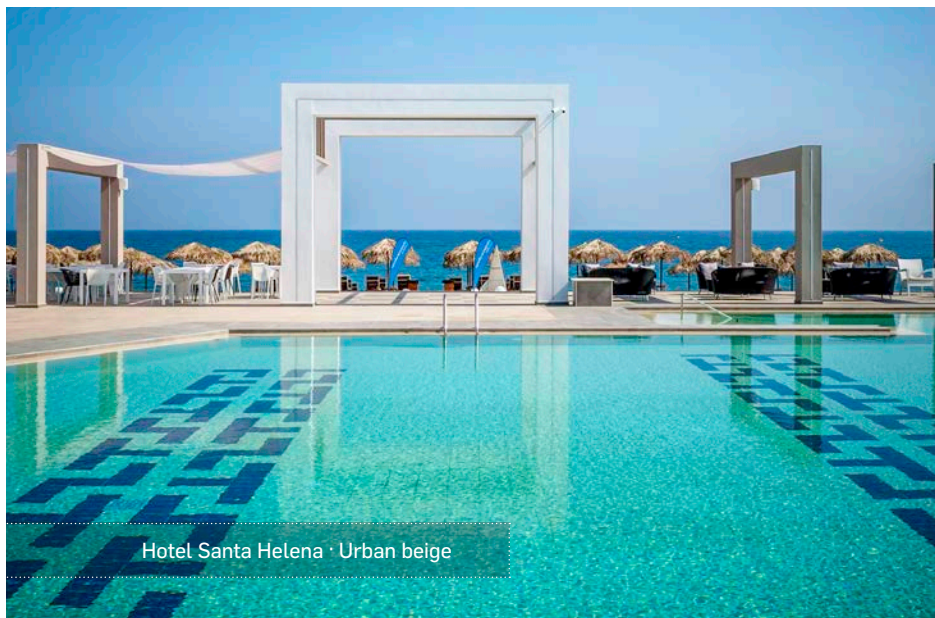

Hotel Santa Helena · Urban beige

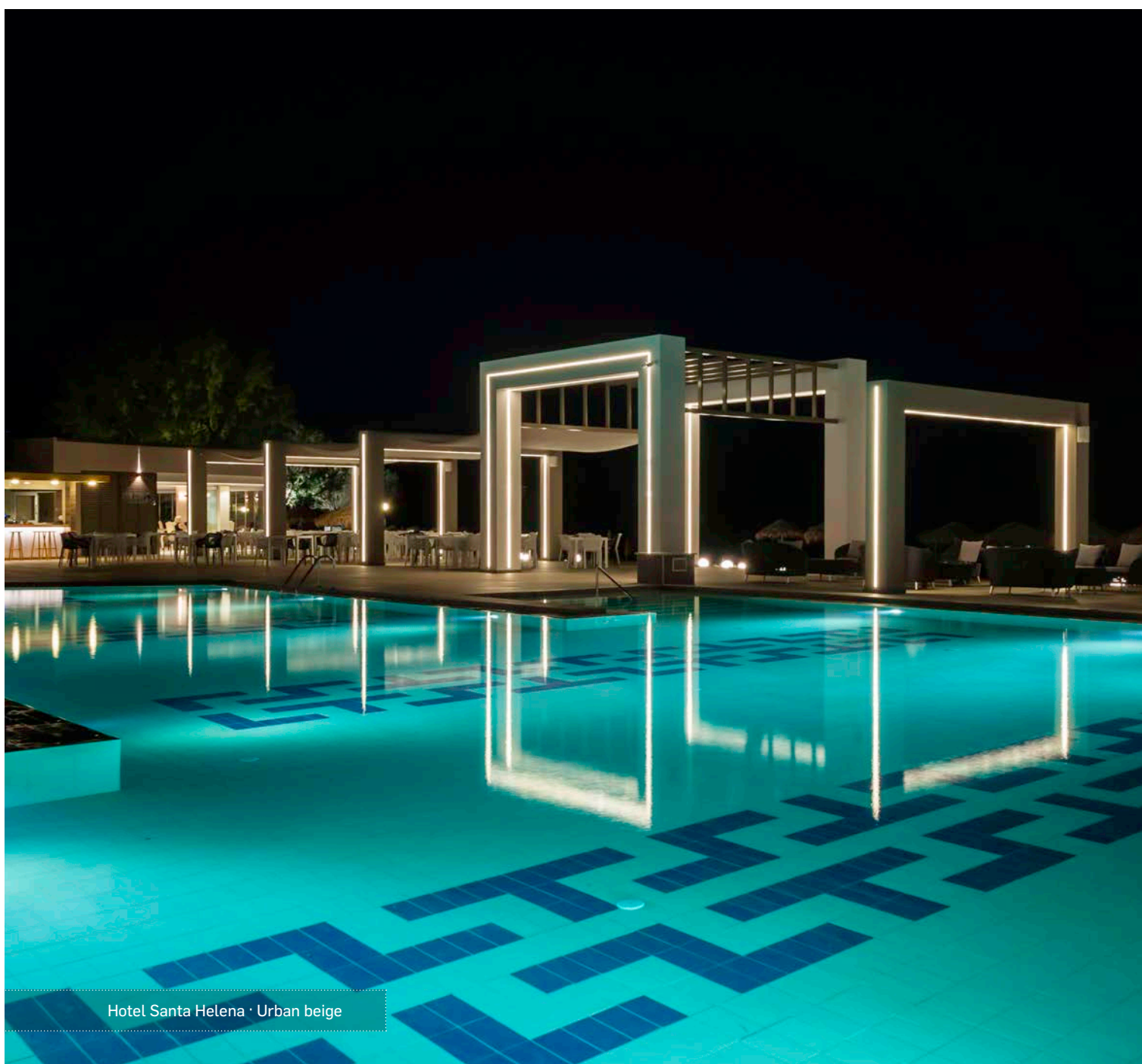

Hotel Santa Helena · Urban beige



Piscina Municipal de Paterna (España) / Paterna Public Pool (Spain) · Urban gris

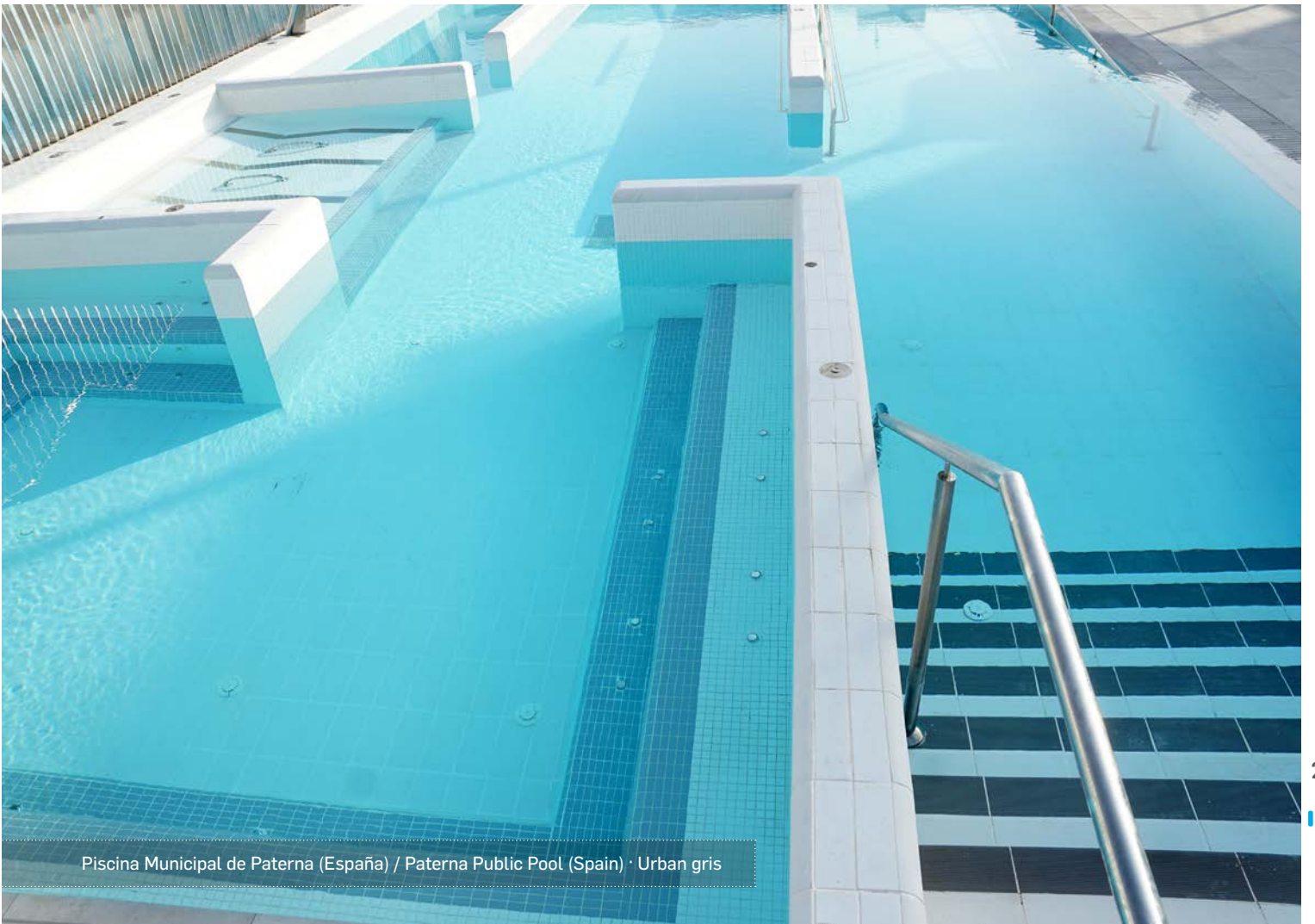

Piscina Municipal de Paterna (España) / Paterna Public Pool (Spain) · Urban gris

Realizaciones
Projects
ACEPOOL
WELLNESS CERAMICS-GRES ARAGON

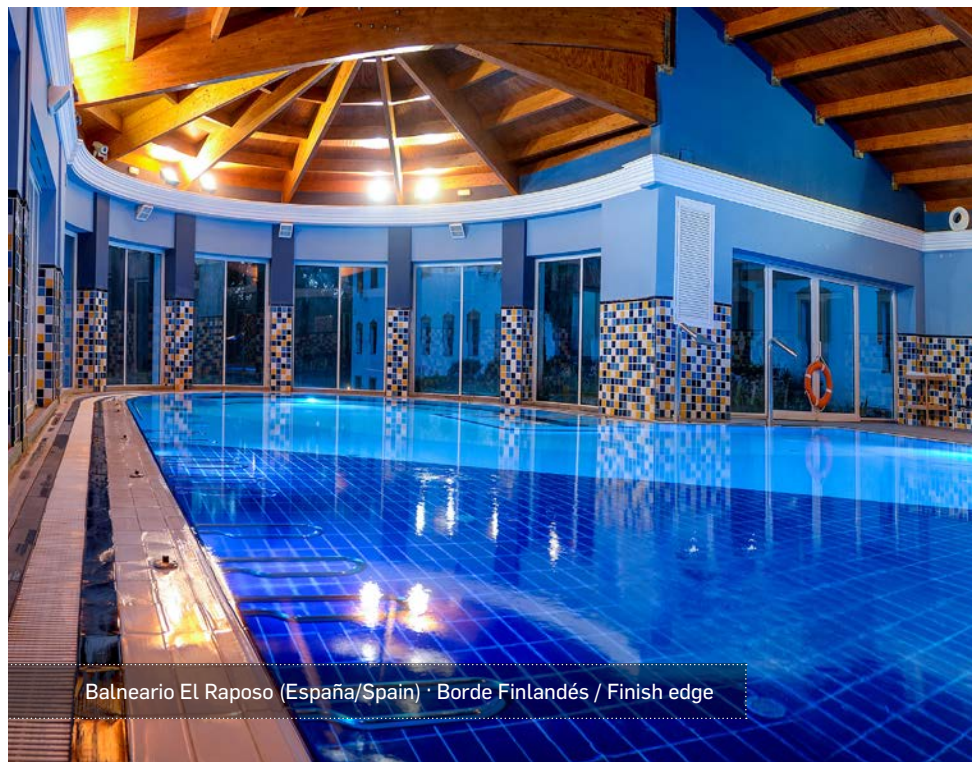

Balneario El Raposo (España/Spain) · Borde Finlandés / Finish edge



Balneario El Raposo (España/Spain) · Borde Finlandés / Finish edge

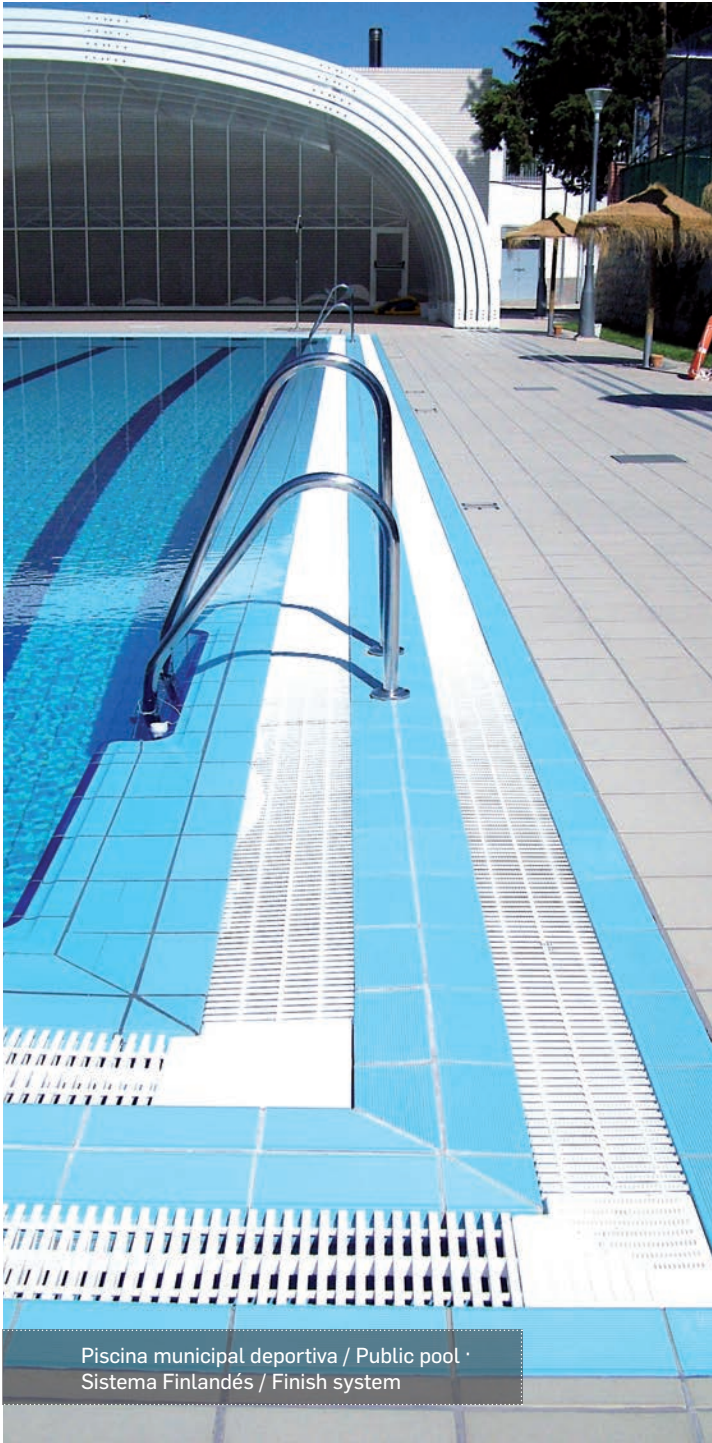

Piscina municipal deportiva / Public pool ·
Sistema Finlandés / Finish system

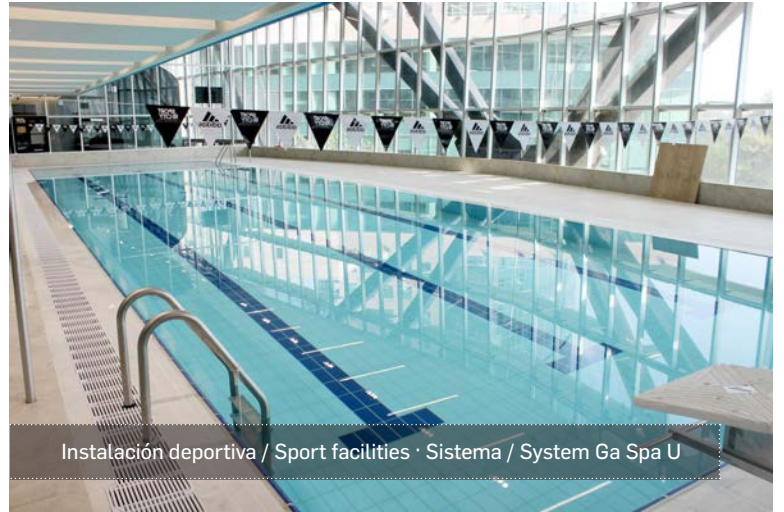

Instalación deportiva / Sport facilities · Sistema / System Ga Spa U

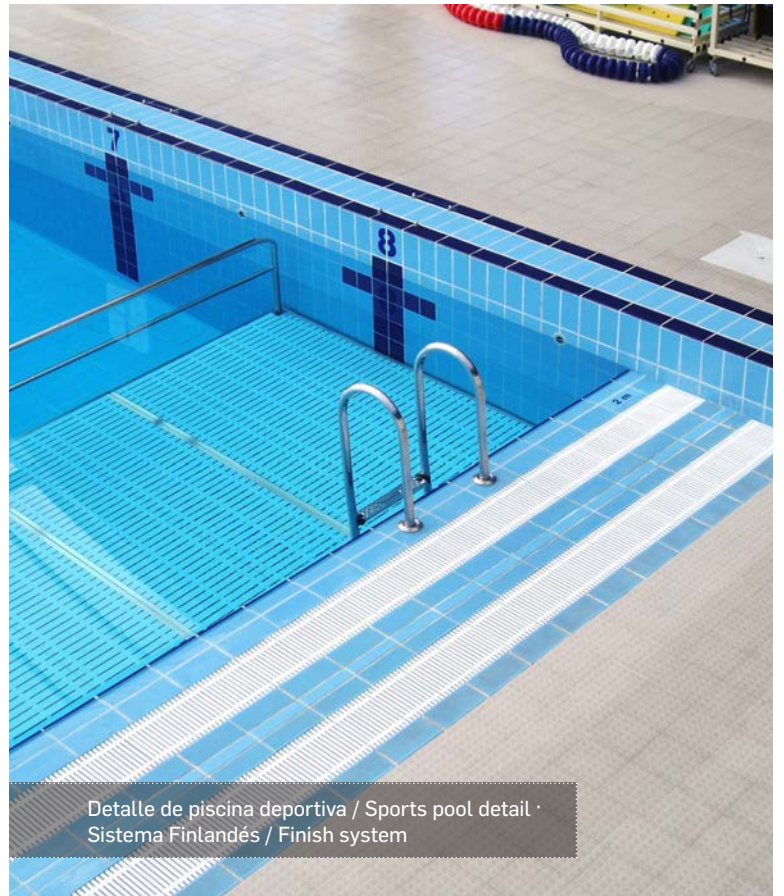

Detalle de piscina deportiva / Sports pool detail ·
Sistema Finlandés / Finish system



Club de Golf Altozano Moreira (Méjico) · Sistema Finlandés













Características técnicas

Technical information

Simbología y normas 225	225
Symbols and Standards	
Colocación de pavimento en exteriores usando adhesivo 226	226
Laying tiles outdoors with adhesive	
Recomendaciones para la colocación de peldaños 229	229
Recommendations for laying step tiles	
Consejos de colocación de piscinas 233	233
Swimming pool laying recommendations	
Recomendaciones para la colocación de rejilla cerámica porcelánica 236	236
Recommendations for the placement of porcelain ceramic grid	
Normas de limpieza y mantenimiento 237	237
Cleaning & Maintenance Guidelines	
Información general 238	238
General information	















GRUPO GROUP
Alla₁ Alla₂

Baldosas extruidas absorción de agua 3%<E<=6%. Características técnicas para series Natural, Quarry, Mytho, Cotto, Classic, Jasper, Columbia, Antic, Stone, Orion, Capri y Retro. Extruded tiles, water absorption 3%<E<=6%. Technical features for Natural, Quarry, Mytho, Cotto, Classics, Jasper, Columbia, Antic, Stone, Orion, Capri and Retro series.



Descripción símbolo Symbol description	Norma de ensayo Standard test	Valor requerido EN 14411:2016 - Anexo B y C Required values	Valor Gres Aragón Gres de Aragon values
 Características dimensionales Dimension tolerance	ISO 10545-2:98	<1,25% máx. 2 mm	Cumple la norma Meets the norm
 Absorción de agua Water absorption	10545-3:2018	Grupo Alla: 3% < E <= 6% Group Alla	3% < E <= 6%
 Resistencia a la flexión Breaking strength	ISO 10545-4:2015	> 20 N/mm ² Grupo Alla1 > 13 N/mm ² Grupo Alla2	De 18 a 25 N/mm ²
 Resistencia a la abrasión profunda Resistance to deep abrasion	ISO 10545-7:99	< 393 mm ³	<393 mm ³
 Resistencia a la abrasión superficial Resistance to surface abrasion	ISO 10545-7:99	De 0 a 5 From 0 to 5	De 2 a 4 From 2 to 4
 Coef. Dilatación térmica lineal Linear thermal expansion coefficient	ISO 10545-8:2014	No exigido/Método disponible Not required /Available method	3,8 x 10 ⁻⁶ °C ⁻¹
 Resistencia al choque térmico Resistance to thermal shock	ISO 10545-9:2013	Exigido Required	Resiste Resists
 Expansión por humedad Moisture expansion	ISO 10545-10:97	No exigido/Método disponible Not required /Available method	0,1 mm/m
 Resistencia al cuarteo Crazing resistance	ISO 10545-11:97	Exigido Required	Resiste Resists
 Resistencia a la helada Frost resistance	ISO 10545-12:97	Exigido Required	Resiste Resists
 Resistencia química Chemical resistance	ISO 10545-13:17	Mínimo UB-GB Minimun UB-GB	HA
 Resistencia a las manchas Resistance to stains	ISO 10545-14:15	Mínimo clase 3 Minimun class 3	Clase 3 a 5 Class 3 to 5
 Desgaste tránsito peatonal Erosion to pedestrian transit	UNE 138001:2008	No Exigido Not Required	H5 - H6

GRUPO GROUP
Ala Bla

Baldosas extruidas y prensadas absorción de agua E<=0,5%. Características técnicas para series Porcelánicas (Marble, Ocean, Ordesa, Itaca, Urban y Tibet) y Línea Técnica. Extruded and pressed tiles, water absorption E<=0,5%. Technical features for Porcelain series (Marble, Ocean, Ordesa, Itaca, Urban and Tibet) and Technical Range.

Descripción símbolo Symbol description	Norma de ensayo Standard test	Valor requerido EN 14411 Required values	Valor Gres Aragón Gres de Aragon values
 Características dimensionales Dimension tolerance	ISO 10545-2:98	Ala: <1% máx. 2 mm Bla: <0,6% máx. 2 mm	Cumple la norma Meets the norm
 Absorción de agua Water absorption	10545-3:2018	E <= 0,5%	E <= 0,5%
 Resistencia a la flexión Breaking strength	ISO 10545-4:2015	Ala: > 28 N/mm ² Bla: > 35 N/mm ²	>35 N/mm ²
 Resistencia a la abrasión superficial Resistance to surface abrasion	ISO 10545-7:99	De 0 a 5 From 0 to 5	De 2 a 5 From 2 to 5
 Coef. dilatación térmica lineal Linear thermal expansion coefficient	ISO 10545-8:2014	No exigido/Método disponible Not required /Available method	5,8 x 10 ⁻⁶ °C ⁻¹
 Resistencia al choque térmico Resistance to thermal shock	ISO 10545-9:2013	Exigido Required	Resiste Resists
 Expansión por humedad Moisture expansion	ISO 10545-10:97	No exigido/Método disponible Not required /Available method	0,1 mm/m
 Resistencia al cuarteo Crazing resistance	ISO 10545-11:97	Exigido Required	Resiste Resists
 Resistencia a la helada Frost resistance	ISO 10545-12:97	Exigido Required	Resiste Resists
 Resistencia química Chemical resistance	ISO 10545-13:17	Mínimo UB-GB Minimun UB-GB	HA
 Resistencia a las manchas Resistance to stains	ISO 10545-14:15	Mínimo clase 3 Minimun class 3	Clase 5 Class 5
 Desgaste tránsito peatonal Erosion to pedestrian transit	UNE 138001:2008	No Exigido Not Required	H5 - H6
 Coeficiente fricción dinámico (DCOF) Dynamic coefficient of friction	ASTM A137.1:2017 Apdo. 9,6	>0,42	0,82
 Antibacteriano Antibacterian	JIS Z-2801:2010 (ISO 22196)	No Exigido Not Required	R>2 Reducción antibacteriana >99%

Características de resistencia al deslizamiento, todas las series / Slip resistance features, all series

Resistencia al deslizamiento Slip resistance	Norma de ensayo Standard test	Valor requerido Required values	Valor Gres Aragón Gres de Aragon values
 A pie calzado Slip resistance with footwear	DIN 51130:2014 Apdo. 9,6	No exigido/Método disponible Not required /Available method	R10 - R11 - R12 - R13
 A pie descalzo Barefoot slip resistance	DIN 51097:92	No exigido/Método disponible Not required /Available method	A - B - C
 Péndulo (CTE) Not required out of Spain	UNE-ENV 12633:03 Anexo A	1-2-3 En función de su localización Exigencia básica de seguridad SU1 del Código Técnico de edificación	1 -2 -3

• Ver nota página 239 / See note page 239

Colocación de pavimento en exteriores usando adhesivo

Laying tiles outdoors with adhesive

GRES ARAGÓN recomienda seguir los criterios establecidos por norma colocación UNE 138002:2017. Reglas generales para la ejecución de revestimientos con baldosas cerámicas por adherencia para garantizar la calidad, durabilidad, y las prestaciones técnicas y estéticas de nuestros productos cerámicos.

GRES ARAGÓN recommends following the criteria established by the UNE 138002: 2017 standard. General rules for the execution of ceramic tiles with adhesion to guarantee the quality, durability, and technical and aesthetic performance of our ceramic products.

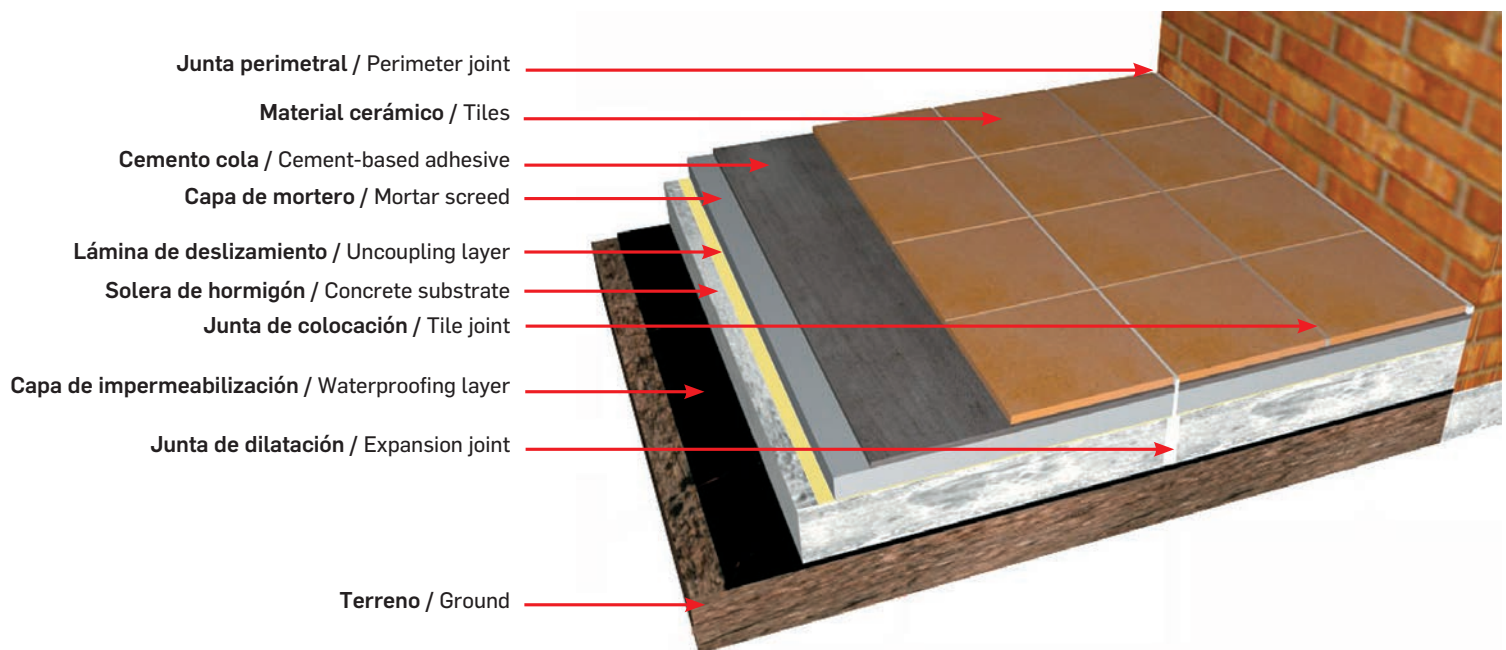

226

PREPARACIÓN DEL RECRECIDO QUE VA A RECIBIR EL PAVIMENTO:

- La solera base debe estar limpia, sin fisuras y bien curada presentando una humedad inferior al 3%.
- Colocar sobre la solera una lámina de PVC para independizar de la solera el relleno de mortero.
- En terrazas, se recomienda colocar una lámina de geotextil sobre la lámina de PVC para realizar el drenaje del agua que pueda pasar debajo del pavimento.
- Efectuar el relleno a base de unos 4 ó 5 cm de mortero pobre (1 parte de cemento x 6 partes de arena) y fratasarlo para que quede bien liso y compactado. Es recomendable armar esta capa con un pequeño mallazo metálico de 2 mm de diámetro de alambre en cuadros de 5x5 cm.
- Evitar el contacto de la capa de relleno con los pilares y las paredes realizando una junta perimetral rellena de Porexpan de 1 cm de espesor.
- Dejar curar la capa de mortero durante 30 días y presente una humedad inferior al 3%.

PREPARING THE FLOOR SCREED FOR THE TILES:

- The substrate should be clean, properly cured, and free from cracks. It should have a moisture content of less than 3%.
- Place PVC sheeting on top of the substrate to separate it from the mortar screed.
- When tiling terraces, a geotextile membrane should be laid on top of the PVC sheeting so that water can drain away under the tiles.
- Make a 4 or 5 cm thick floor screed, using a standard ratio of 1 part cement to 6 parts sand. Level it well, making sure that it is smooth and compact. This layer should be reinforced with wire mesh, made of 2 mm diameter wire with 5x5 cm openings.
- Make sure that the floor screed does not come into contact with columns or walls by inserting a perimeter joint, filled with 1 cm-thick expanded polystyrene.
- Leave the mortar to set for 30 days, until it has a moisture content of less than 3%.

COLOCACIÓN DEL PAVIMENTO:

- El pavimento en exterior se recomienda colocar con adhesivo del tipo C2 E S1 según norma UNE-EN 12004. Esta nomenclatura es habitual entre todos los fabricantes de adhesivos para baldosas y significa "Adhesivo cementoso mejorado para exteriores con tiempo abierto ampliado y deformable. Deben seguirse las normas de preparación y aplicación recomendadas por el fabricante del adhesivo.
- En ningún caso se debe aplicar el adhesivo en condiciones climatológicas adversas: temperaturas inferiores a 5°C o superiores a 35°C, lluvia o fuerte viento.
- No debe superarse el tiempo abierto del adhesivo (tiempo máximo que puede transcurrir desde la preparación hasta la colocación de la baldosa).
- Todas las baldosas se colocarán con la misma orientación de la pana que llevan en el dorso, para facilitar su adherencia.
- Para cortar las baldosas, usar una máquina de cortar con disco refrigerado por agua.
- Se extenderá el adhesivo con un paleta y se extenderá y peinará con una llana dentada de al menos 10 mm de profundidad de diente. Se alisará con la parte plana de la llana hasta dejar la superficie completamente cubierta de adhesivo sin dejar ningún hueco.
- En exteriores se recomienda el doble encolado, extendiendo una fina capa de adhesivo en el reverso de la baldosa hasta quedar totalmente cubierta. El objetivo del doble encolado es mejorar la adhesión y evitar que queden huecos debajo de las baldosas en donde pueda acumularse el agua de lluvia.
- Colocar la baldosa en su sitio ayudándose, si es necesario, de crucetas de plástico para guardar las juntas de colocación entre las piezas cerámicas. Se recomienda una junta de 6-8 mm. Asegurarse que la baldosa queda bien asentada y nivelada con respecto a las piezas del contorno.

LAYING THE TILES:

- The outside tiles should be laid with a type C2 E S1 adhesive, as per standard UNE-EN 12004. This is the standard name used by tile adhesive manufacturers for "improved deformable cement-based adhesives for outdoor use" with an extended open time. Follow the adhesive manufacturer's instructions for preparing and applying the adhesive.
- Under no circumstances should the adhesive be applied in adverse weather conditions, i.e. temperatures below 5°C or above 35°C, or in rain or strong winds.
- The adhesive's open time should not be exceeded (i.e. the maximum working time for laying the tiles from the moment that the adhesive is ready for use).
- All the tiles should be laid with the grooves on the underside pointing in the same direction to facilitate the bonding process.
- To cut the tiles, use a wet tile saw.
- Spread the adhesive with a spatula and comb it using a notched trowel with at least 10mm teeth. Smooth it with the unnotched side of the trowel until the entire underside of the tile is covered in adhesive, leaving no gaps.
- When tiles are laid outdoors, the floating and buttering method should be used, spreading a thin layer of adhesive over the underside of the tiles until they have been fully covered. The purpose of this method is to ensure a firmer bond and to avoid gaps under the tiles where rainwater might accumulate.
- Position the tiles, using plastic spacers if necessary to keep the right distance between them. A 6-8 mm tile joint should be left. Make sure that the tiles are firmly positioned and level with the rest of the tiled surface.

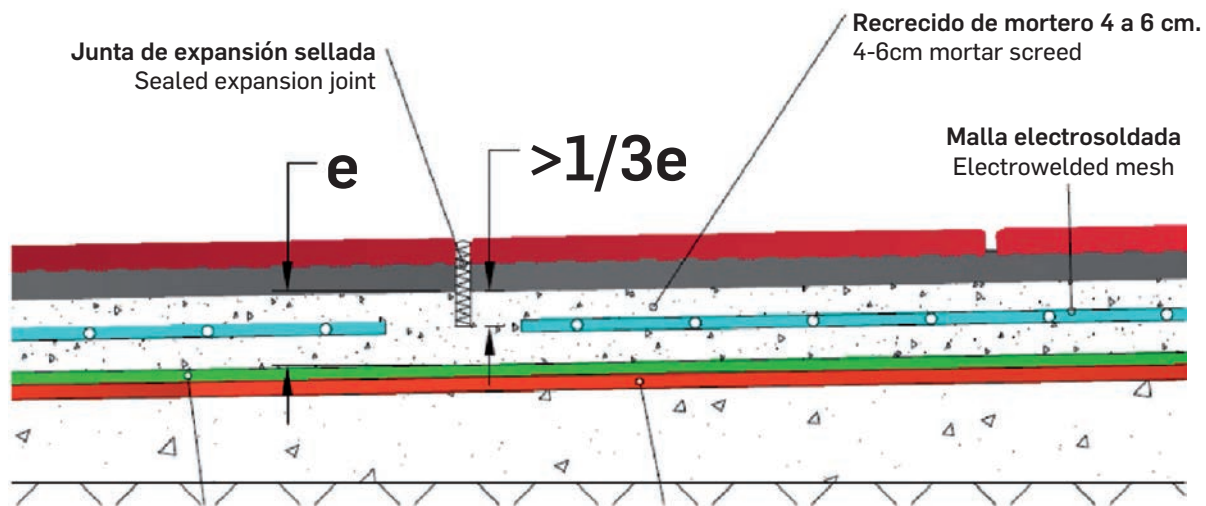

REJUNTADO Y LIMPIEZA DEL PAVIMENTO:

- Se deben dejar transcurrir 24 horas antes de pisar el pavimento.
- Para el relleno de las juntas de colocación se usará mortero cementos CG2 según norma UNE-EN 13888. Esta nomenclatura es habitual entre todos los fabricantes de pastas de rejuntado significa "Mortero de juntas mejorado para su uso en exteriores". Estos morteros existen en múltiples colores.
- Preparar y aplicar la pasta de rejuntar siguiendo las instrucciones del fabricante. Debe asegurarse relleno total de las juntas entre baldosas, y no aplicar las pasta en condiciones climatológicas adversas que pueden provocar el posterior cuarteo y deterioro de la misma.
- La limpieza del material de rejuntar sobrante debe hacerse sin dejar transcurrir demasiado tiempo utilizando agua limpia y una esponja.

JUNTAS DE DILATACIÓN:

- Las juntas de dilatación son esenciales en la colocación en exteriores. Su objetivo es absorber los movimientos que sufren las baldosas con los cambios de temperatura, evitando las tensiones y las fisuras de las piezas cerámicas.
- Se recomienda realizar juntas de dilatación cada 4 m Como máximo, cada paño tendrá una superficie de 16 m².
- Debe haber una junta de dilatación perimetral que separe el pavimento de los paramentos verticales, pilares, etc.
- También deben prepararse juntas de dilatación encima de las juntas estructurales propias de la edificación.
- Las juntas de dilatación deben profundizar hasta atravesar aproximadamente 1/3 del espesor del relleno de mortero sobre el que se ha pegado la pieza cerámica. De esta forma los posibles movimientos por temperatura romperán la losa de relleno por la junta evitando roturas incontroladas por otras zonas que puedan afectar al pavimento superpuesto.
- Las juntas se rellenarán colocando en el fondo un cordón comercial flexible sobre el que se extiende un adhesivo impermeable tipo Sikaflex que realiza el sellado de la junta. Es muy importante que este sellado final no se desprenda de los espesores de las baldosas entre las que se ha colocado para evitar la entrada de agua.
- Igualmente la junta perimetral debe rellenarse con el cordón flexible y sellarse con Sikaflex o similar para permitir su movimiento y evitar la penetración de la humedad debajo del pavimento.

LIMPIEZA FINAL:

- Para realizar la limpieza final se utilizará agua. En ocasiones se puede añadir una solución ácida para ayudar a eliminar los restos del material de agarre y de rejuntado.
- En los distribuidores de materiales de construcción se pueden encontrar quitacimientos y otros productos adecuados para la limpieza final.

GROUTING AND CLEANING THE TILED SURFACE:

- Wait for 24 hours before treading on the tiled surface.
- To fill the tile joints, use a CG2 type grouting mortar, as per standard UNE-EN 13888. This is the standard name used by grouting manufacturers to refer to "improved grouts for use outdoors". These grouts come in numerous different colors.
- Prepare and apply the grouting material, as per the manufacturer's instructions. Make sure that the entire tile joint is filled. Do not apply the grout in adverse weather conditions that might cause it to crack or diminish its properties.
- Do not wait too long before cleaning away any surplus grouting material. Use clean water and a sponge to remove it.

EXPANSION JOINTS:

- Expansion joints are essential when laying tiles outdoors. They absorb movements that might affect the tiles, caused by changes in temperature, preventing stress forces or cracks in the tiles.
- Expansion joints should be inserted every 4 metres, so that the maximum area covered by a continuous stretch of tiles is 16 sqm.
- A perimeter expansion joint should be inserted, separating the tiled floor from walls, columns etc.
- Expansion joints should also be inserted on top of the building's structural joints.
- The expansion joints should penetrate about 1/3 of the depth of the floor screed on which the tiles have been laid. In this way, the floor screed will crack along the joint in the event of possible movements caused by changes in temperature, avoiding uncontrolled breaks or cracks in other areas that might affect the tiled surface on top of it.
- Fill the joints with a flexible material and then seal them with a waterproof adhesive sealant like Sikaflex. It is very important for the final seal to fill the entire tile joint right up to the top surface of the tiles, so as to prevent water from entering it.
- Likewise, the perimeter joints should also be filled with a flexible material and then sealed with Sikaflex or a similar product to absorb movements and prevent moisture from filtering underneath the flooring.

THE FINAL CLEANING PROCESS:

- Use water to clean up afterwards. On occasions, an acidic solution can be used to help remove the remains of bonding or grouting material.
- Cement removers and other suitable products for cleaning up afterwards can also be purchased from building suppliers.

Recomendaciones para la colocación de peldaños

Recommendations for laying step tiles

GRES ARAGÓN recomienda seguir los criterios establecidos por norma colocación UNE 138002:2017. Reglas generales para la ejecución de revestimientos con baldosas cerámicas por adherencia para garantizar la calidad, durabilidad, y las prestaciones técnicas y estéticas de nuestros productos cerámicos.

GRES ARAGÓN recommends following the criteria established by the UNE 138002:2017 standard. General rules for the execution of ceramic tiles with adhesion to guarantee the quality, durability, and technical and aesthetic performance of our ceramic products.

RECOMENDACIÓN GENERAL

Gres Aragón recomienda en exteriores el uso de adhesivos tipo C2 TE S1 (Adhesivo cementoso mejorado para su uso en exteriores, con tiempo abierto ampliado y deformable) y material para juntas tipo CG2 (EN 138888). Todos los fabricantes de cemento cola disponen de este tipo de materiales desarrollados para la colocación en exteriores.

No se descarta la colocación con mortero tradicional, bajo responsabilidad del colocador y nunca se recomienda en exteriores con riesgo de heladas.

GENERAL GUIDELINES

When tiles are laid outdoors, Gres Aragón recommends the use of C2 TE 51 type adhesives (improved deformable cement-based adhesives for outdoor use, with an extended open time) and CG2 type grouting material (grouts for outdoor use with a low water absorption rate and resistance to abrasion).

All manufacturers of cement-based adhesives make materials of this kind for outdoor use.

It is possible to lay the tiles with the traditional cement mortar method, but the tile layer will be responsible for ensuring the proper preparation and application of the mix. Do not use it in outdoors.



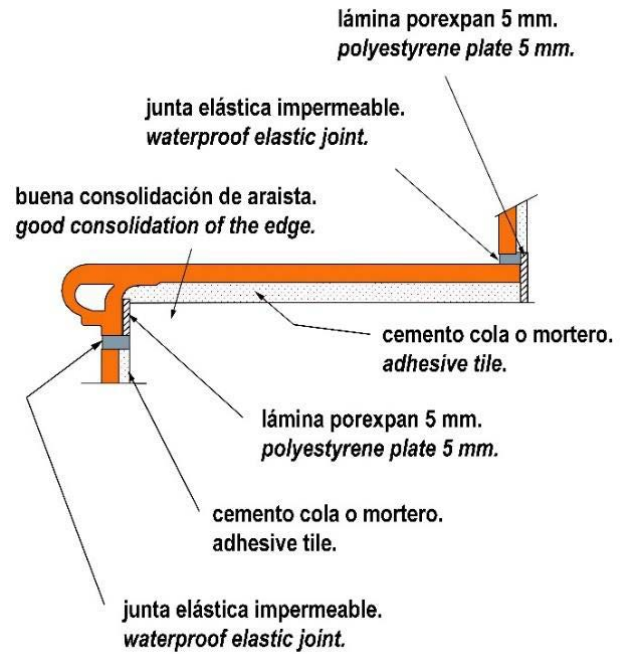
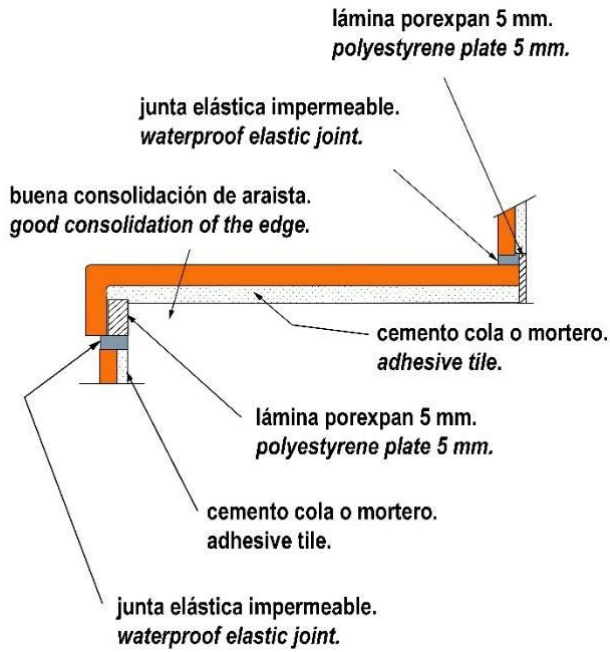

CONSEJOS PARA LA COLOCACIÓN DEL PELDAÑO

1. El soporte debe estar curado, seco y bien conformado, especialmente la arista delantera.
2. Efectuar doble encolado en los peldaños, extendiendo adhesivo tanto sobre el soporte como en la cara posterior del peldaño. El peldaño debe quedar totalmente macizado y sin huecos.
3. Se recomienda que el perfil delantero descansa sobre el espesor de la tabica vertical. Se colocará lámina de porexpan de 5 mm de espesor en la parte trasera del perfil. Se rejuntará con junta elástica impermeable.
4. El espesor trasero del peldaño se independizará de la pared con porexpan de 5 mm y se rejuntará con junta elástica impermeable.
5. En escaleras encajadas entre 2 muros, se practicarán juntas de dilatación en los encuentros con los muros.
6. En escaleras muy anchas, se practicarán juntas de dilatación cada 4 m de longitud.
7. Las láminas de porexpan y las juntas de dilatación flexibles e impermeables permiten absorber los movimientos de dilatación y evitan la entrada de agua en el substrato.
8. Dejar fraguar antes de pisar.

TIPS FOR LAYING STEP TILES

1. The substrate should be properly formed, cured and dry, particularly its front edge.
2. Use the floating and buttering method to lay the step tiles so as to ensure a void-free solid bond.
3. The front edge of the step tile should rest on the top edge of the riser. A 5 mm extruded polystyrene plate should be inserted between the front edge of the step ante wall, and then grouting the joint using a waterproof elastic material.
4. The back edge of the step tile should be kept separate from the wall by inserting 5 mm of extruded polystyrene and then grouting the joint.
5. When the stair is fitting between two walls, expansion joints should be left between stair and walls.
6. In wide stairs, leave expansion joint every 4 m.
7. Using the porexpan plate and expansion joints filling in with waterproof elastic materials any expansion will be absorbed and no water will filter through.
8. Wait until is completely dry before stepping the wings.

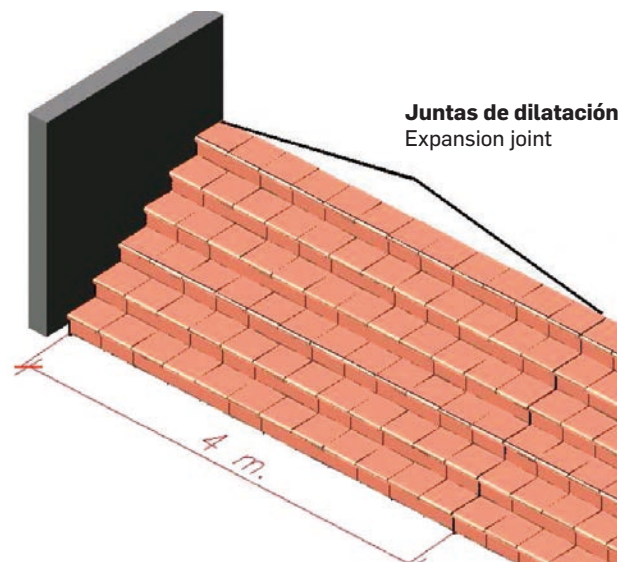

Manual de colocación de peldaños porcelánicos de gran formato

Laying instructions for large format porcelain steps

1



Para una buena colocación de peldaños de gran formato, el primer paso es maestrear el soporte de la escalera, para que todos los peldaños de la escalera tengan las mismas dimensiones, tanto la huella como la contrahuella y una correcta nivelación en el eje X e Y.

For a good placement of large-format steps, the first step is to master the support of the ladder, so that all the steps of the ladder have the same dimensions, both the tread and the riser and a correct leveling in the X and Y axis.

2



Antes de empezar a colocar ninguna pieza cerámica, es conveniente hacer un replanteo colocando peldaños, tabicas y zanquines en un par de escaleras. El objetivo es comprobar que todas las medidas están bien coordinadas.

Before starting to place any ceramic pieces, it is convenient to do a layout by placing steps, risers and stilts on a pair of stairs. The objective is to check that all the measures are well coordinated.

3

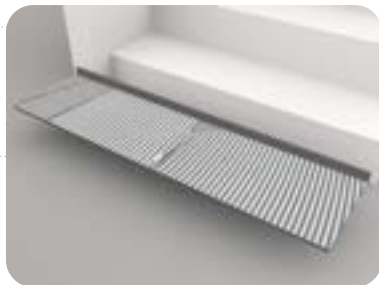

Una vez realizado el replanteo, procederemos a extender el adhesivo en la huella del escalón y peinar con llana dentada. Además extenderemos adhesivo por el reverso del peldaño con el lado liso de la llana. Este tipo de colocación se denomina "doble encolado", y se emplea para que el peldaño quede totalmente macizado y sin huecos en el adhesivo.

Once the layout is done, we will proceed to spread the adhesive on the tread of the step and comb with a notched trowel. We will also spread adhesive on the back of the step with the smooth side of the trowel. This type of installation is called "double gluing", and it is used so that the step is completely solid and without gaps in the adhesive.

4



El adhesivo del soporte de la huella siempre se debe peinar en línea recta y perpendicular a una arista del escalón para conseguir un correcto reparto del adhesivo al presionar y evitar huecos.

The adhesive of the tread support must always be combed in a straight line and perpendicular to an edge of the step to achieve a correct distribution of the adhesive when pressing and avoid gaps.

5

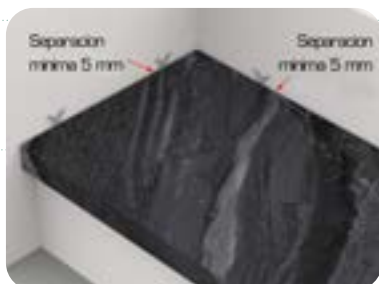

Una vez que procedamos a unir el peldaño cerámico con el escalón de obra, tendremos en cuenta, que no se puede tocar directamente con las paredes. Tendremos que dejar una junta mínima de 5 mm con la pared posterior y 5 mm con la pared lateral, para ello podemos usar crucetas para guardar las medidas, que se deberán quitar cuando el adhesivo este curado. Es imprescindible que la junta quede libre de adhesivo y se pueda rellenar de material flexible.

Once we proceed to join the ceramic step with the work step, we will take into account that it cannot be directly touched with the walls. We will have to leave a minimum joint of 5 mm with the back wall and 5 mm with the side wall. For this, we can use spacers to save the measurements, which must be removed when the adhesive is cured. It is essential that the joint is free of adhesive and can be filled with flexible material.

6



Deberemos dejar 15 mm de vuelo entre la pared frontal y la parte interior del perfil delantero del peldaño. Esta separación la deberemos rellenar con algún elemento flexible como, porexpan, espuma o masilla elástica.

We must leave 15 mm of space between the front wall and the inside of the front profile of the step. This separation must be filled with a flexible element such as polystyrene, foam or elastic putty.

7



Durante la colocación y antes del fraguado del adhesivo, es muy importante comprobar los niveles de planimetría de eje X e Y. Esta operación se tendrá que hacer en todos los peldaños, por si hay que hacer alguna pequeña corrección.

For a good placement of large-format During placement and before the adhesive has set, it is very important to check the X and Y axis flatness levels. This operation will have to be done on all the steps, in case any small correction needs to be made.

8



Una vez colocados los peldaños, procederemos a la colocación de las tabicas por el método del doble encolado. Es muy importante que no se toque cerámica con cerámica, dejando una junta mínima de 3 mm entre el peldaño y la tabica. Esta junta se deberá rellenar de material de junta elástica e impermeable.

Once the steps have been placed, we will proceed to the placement of the risers by the double gluing method. It is very important not to touch ceramic with ceramic, leaving a minimum joint of 3 mm between the step and the riser. This joint should be filled with elastic and waterproof joint material.

9



A la hora de colocar la tabica también es adecuado colocar un nivel para asegurarnos que la tabica está perfectamente perpendicular al peldaño.

When placing the riser it is also appropriate to place a level to ensure that the partition is perfectly perpendicular to the step.

10



Una vez colocados el peldaño y la tabica, procederemos con la colocación de los zanquines. Alrededor del zanquin siempre debe respetarse una junta mínima de 3 mm.

Once the step and the riser have been placed, we will proceed with the placement of the strings. A minimum joint of 3 mm must always be respected around the string.

11

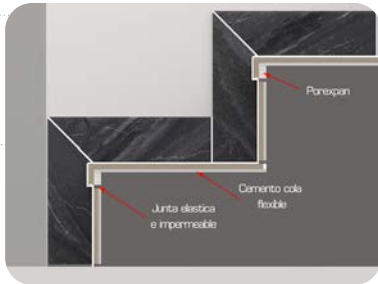

Para este tipo de colocación disponemos de zanquines que llevan el retranqueo de la superficie que vuela.

For this type of placement we have strings that carry the setback of the flying surface.

El peldaño queda volado respecto a la tabica, esto se hace por dos razones: la primera para absorber las tensiones de dilatación-contracción de la escalera, que en exteriores son más extremas; y segunda para que el agua no ensucie las tabicas con el goterón que tiene el perfil delantero del peldaño.

The step remains overhang with respect to the riser, this is done for two reasons: the first to absorb the expansion-contraction stresses of the ladder, which are more extreme outdoors; and second, so that the water does not dirty the walls with the drip that has the front profile of the step.

12



Si la escalera es abierta por un lado, para que no se vea el perfil del peldaño podemos emplear una tapa cerámica.

If the ladder is open on one side, so that the profile of the step is not visible, we can use a ceramic cover top.

La tapa cerámica se debe colocar respetando la junta mínima de 3 mm, nos podremos ayudar de crucetas. En el caso de descuelgue, ya que es una pieza de poca superficie, podremos ayudarnos de cinta de carroceros para su perfecta adhesión que se retirará cuando el adhesivo haya curado.

The ceramic cover must be placed respecting the minimum joint of 3 mm, we will be able to use spacers. In the case of sagging, since it is a piece with a small surface area, we can help ourselves with masking tape for its perfect adhesion that will be removed when the adhesive has cured.

13



Para una correcta colocación del material y garantizar la durabilidad es recomendable utilizar adhesivo tipo C2 TE S1 y material para juntas tipo CG2.

For a correct placement of the material and to guarantee durability it is recommended to use adhesive type C2 TE S1 and joint material type CG2.

En escaleras muy anchas, se practicarán juntas de dilatación de material flexible cada 4 m de longitud.

In very wide staircases, expansion joints of flexible material will be made every 4 m in length.

Si hubiese alguna junta estructural, habrá que respetar esta junta con el material cerámico y rellenarla de material flexible.

If there is any structural joint, this joint must be respected with the ceramic material and filled with flexible material.

Consejos de colocación de piscinas

Swimming pool laying recommendations

Todos los elementos que intervienen en el revestimiento de una piscina: soporte, adhesivo, baldosa y juntas deben estar correctamente ejecutados empleándose los materiales adecuados.

Para la colocación de porcelánico se usará adhesivo (cemento cola), respetando las instrucciones del fabricante del mismo.

GRES ARAGÓN recomienda seguir los criterios establecidos por norma colocación UNE 138002:2017. Reglas generales para la ejecución de revestimientos con baldosas cerámicas por adherencia para garantizar la calidad, durabilidad, y las prestaciones técnicas y estéticas de nuestros productos cerámicos.

All the components involved in tiling a pool - the substrate, adhesive, tiles, and grouts - must be properly handled, made or prepared, using appropriate materials.

To lay porcelain tiles, use a cement-based adhesive, following the adhesive manufacturer's instructions.

GRES ARAGÓN recommends following the criteria established by the UNE 138002: 2017 standard. General rules for the execution of ceramic tiles with adhesion to guarantee the quality, durability, and technical and aesthetic performance of our ceramic products.

EL SOPORTE (vaso y playa):

- Sólo un soporte estable y resistente garantiza un buen resultado final. La superficie a recubrir se ejecutará con un mortero de calidad mínima M-80 (resistencia a la compresión 80 Kg/cm²) y debiendo alcanzar una resistencia a la tracción superficial de 1 N/mm².
- El vaso debe ser estanco por sí mismo, mediante el uso de aditivos en masa o imprimaciones cementosas. La cerámica y las juntas no garantizan la estanqueidad.
- Deberán practicarse juntas de dilatación para aliviar las tensiones por cambios térmicos.
- Ejecutado el vaso, deben pasar al menos 28 días para el curado y retracción del hormigón.
- Se necesita un buen acabado superficial: limpio, seco, plano y sin irregularidades. Habitualmente las paredes de la piscina están maestreadas.

THE SUBSTRATE (the basin & surround):

- A stable, resistant substrate is fundamental in order to guarantee good end results. A mortar classed at least M-80 (with a compressive strength of 80 kg/cm²) should be used to make it. It should have a tensile strength of up to 1 N/mm².
- The basin must be waterproofed, using cement-based primers or by adding a specific additive to the mix. The tiles and grouted tile joints do not, in themselves, guarantee a waterproof finish.
- Expansion joints must be inserted to absorb movements caused by changes in temperature.
- Once the basin has been made, leave it for at least 28 days for the concrete to cure and for any shrinkage to take place.
- A good surface finish is essential. It should be clean, dry, level and even. Walls of pools are usually screeded.



EL ADHESIVO:

Se usarán exclusivamente **adhesivos cementosos tipo C2 TE**, adecuados para la colocación de baldosas porcelánicas de muy baja absorción de agua, preparados y aplicados según las instrucciones del fabricante y siguiendo estas etapas:

- **Replanteo:** a partir de dos ejes perpendiculares entre sí, se jugará con las baldosas sueltas para encontrar el reparto más adecuado. Se respetarán las siguientes reglas:
 - Trazar una cuadrícula de referencia con una marca cada metro. (fig. 1)
 - Las baldosas se colocarán con una separación de 6 mm (juntas de colocación).
 - Colocar las piezas de las esquinas de la coronación para fijar el nivel de rebosamiento. Seguir después con el resto del borde superior de la piscina. (figs. 2 y 3)
 - A continuación ejecutar las aristas interiores donde se encuentran los diferentes planos. Primero las verticales después las horizontales. (fig. 4)
 - Revestir las paredes desde la coronación hasta el fondo, quedando los cortes abajo. Las calles y la cuadrícula sirven de referencia. Finalizar con el fondo. (figs. 5 y 6)
 - Prever **juntas de dilatación** cada 4 m, evitando superficies superiores a 16 m² sin juntas y coincidiendo con las juntas de dilatación practicadas en el vaso.
- **Colocación:** Respetar las recomendaciones de preparación del adhesivo, tiempo de uso y temperaturas de aplicación.
 - Extender el mortero, peinando con una llana dentada de 6 a 10 mm en paños inferiores a 1 m² para evitar su secado.
 - Si se encola también la baldosa aumenta la adherencia más de un 30%.
 - Mover y presionar ligeramente las piezas para asentar toda la superficie.
 - Nivelar y eliminar el exceso de adhesivo dejando las juntas vacías y limpias.

THE ADHESIVE:

Only **type C2 TE cement-based adhesives** should be used, suitable for laying porcelain tiles with a very low water absorption rate. The adhesive should be prepared and applied as per the manufacturer's instructions, following these stages:

- **Layout planning.** Starting out with two perpendicular lines, plan the layout of the tiles, following these rules:
 - Mark out a reference grid, with a one-metre space between each line. (fig. 1)
 - Leave a 6 mm gap between the tiles (the tile joint).
 - First position the corner coping tiles to determine the overflow level, followed by the tiles along the top edge of the pool. (figs. 2 and 3)
 - Next plan the layout along the inner edges where the different surface planes meet.

First plan the layout of the tiles along the vertical edges, followed by the horizontal ones. (fig. 4)

- The walls should be tiled from top to bottom, laying the cut tiles along the bottom. The lanes and grid will serve as a reference. Lastly, continue with the bottom of the pool. (figs. 5 and 6)
- Insert expansion joints every 4 metres, so that the maximum area covered by a continuous stretch of tiles is 16 m². These expansion joints should coincide with those of the basin.
- **Laying the tiles:** Follow the manufacturer's instructions regarding the preparation of the adhesive, its working time and application temperature.
 - Spread the mortar over an area of less than 1 sqm so that it does not dry before required. Then comb it with a 6 to 10 mm notched trowel.
 - By also spreading it over the underside of the tile, the bonding strength will be increased by over 30%.
 - Move the tile slightly and press it down to ensure full contact with the base.
 - Level the tiles and remove any surplus adhesive, leaving the tile joints empty and clean.

EL REJUNTADO:

Existen materiales específicos para cada tipo de junta, debiendo atenderse las instrucciones del fabricante de cada producto.

- Antes de rejuntar esperar 48 horas sin pisar el pavimento.
- Ejecutar primero las juntas de colocación con pastas impermeables del tipo CG2. Las juntas epoxi permiten la limpieza con elementos más agresivos.
- Aplicar el producto con llana de goma, rellenando diagonalmente.
- Limpiar las juntas antes de que se endurezcan usando quitacementos. El tiempo de fraguado depende del fabricante.
- Realizar por último las juntas de dilatación, rellenando con pastas elásticas impermeables tipo poliuretanos o polisulfuros.
- Dejar secar el conjunto al menos 21 días antes de llenar la piscina.

GROUTING:

Specific materials can be found for the type of joint in question. Follow the manufacturer's instructions in each case.

- Wait for 48 hours before grouting the tiles. Do not tread on them during this time.
- First grout the tile joints, using a CG2 type waterproof grout. Epoxy grouts can be cleaned with tougher cleaning products.
- Use a rubber trowel to apply the grout, filling the joints diagonally.
- Clean the joints before the grout hardens, using cement remover. The setting time will depend on the specific product.
- Lastly, fill the expansion joints, using waterproof elastic polyurethane or polysulfide sealants.
- Leave the whole pool to dry for at least 21 days before filling it.

Consejos de colocación de piscinas
Swimming pool laying recommendations

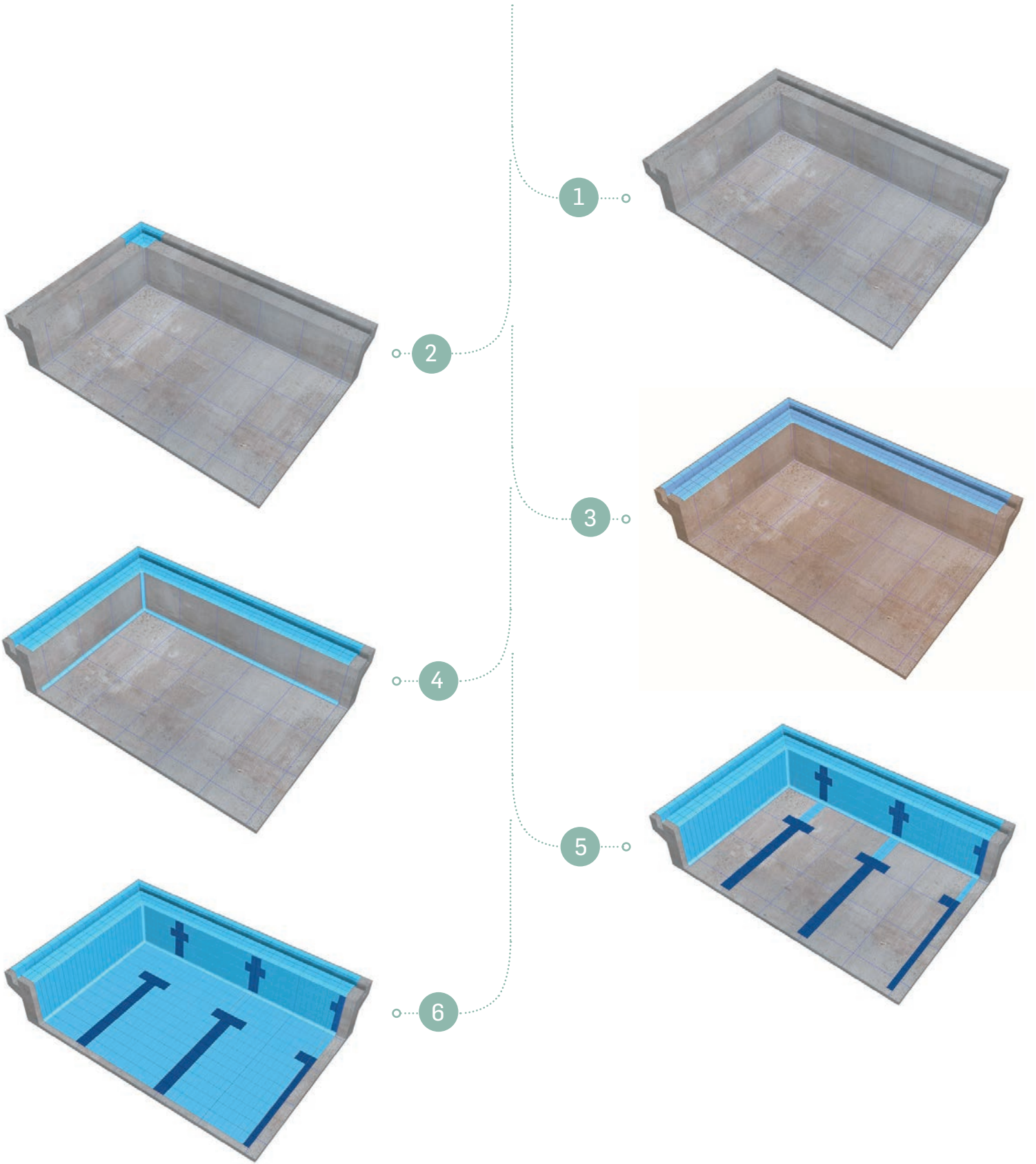

Recomendaciones para la colocación de rejilla cerámica porcelánica

Porcelain ceramic grid layout recommendations

- La rejilla cerámica está diseñada para tener una carga de rotura suficiente para el tránsito peatonal, no obstante, para disponer de plenas prestaciones, únicamente se debe colocar en el sentido que recomienda Gres Aragón.
- The ceramic grid is designed to have an enough breaking load for pedestrian traffic, however, to have full performance, it should only be placed in the direction recommended by Gres Aragón.
- Las piezas de rejilla no se rejuntan entre sí, el espacio entre piezas también es superficie para el desalojo de agua.
- The grid pieces must not be joined together, the space between the pieces is also a surface for the evacuation of water.

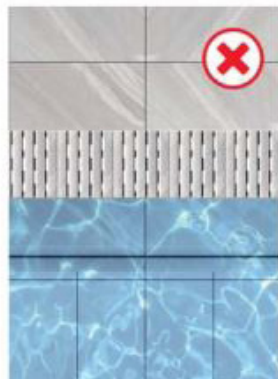
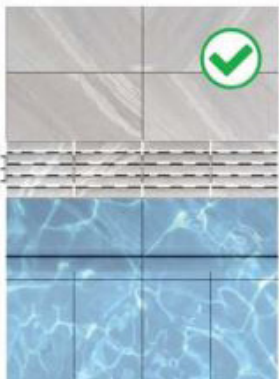
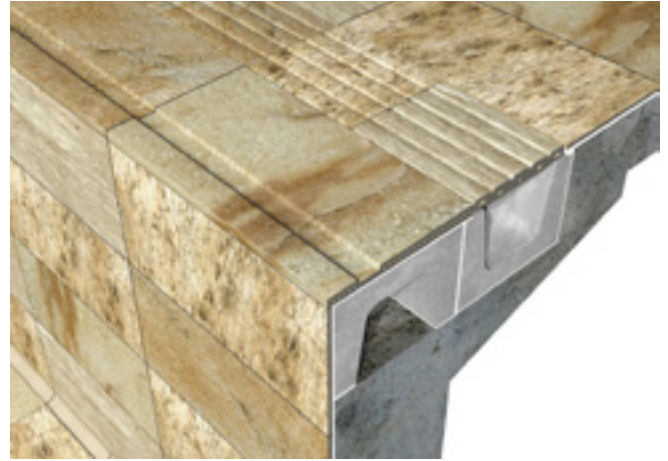

- Dado el carácter duro y rígido de la cerámica, el asiento de las piezas de rejilla debe ser lo más liso y uniforme posible, sin rugosidades y estar perfectamente limpio para un correcto apoyo.
- Due the hard and rigid nature of the ceramic, the seat of the grid pieces must be as smooth and uniform as possible, without roughness and be perfectly clean for proper support.
- Si el apoyo es sobre material cementoso, se puede fijar una de cada tres o cuatro piezas para limitar su posible desplazamiento con cemento cola, con una pistola de inyección, en las hendiduras paralelas del reverso de la pieza.
- If the support is cement material, one of every three or four pieces can be fixed to limit its possible displacement with cement glue, with an injection gun, in the parallel slits of the reverse of the piece.

- Si el soporte es cerámico, se recomienda poner en la ranura una junta tórica de EPDM de diámetro 5 mm, para evitar su movimiento.
- If the support is ceramic, it is recommended to put in the slot an O-ring of EPDM with a diameter of 5 mm, to prevent its movement.
- En cualquier caso, se recomienda colocarlas sobre el sistema Acepool B-33 de GRES ARAGÓN para un óptimo resultado.
- In any case, it is recommended to place them on the Acepool B-33 system of GRES ARAGÓN for an optimal result.



- Para una correcta ejecución, tanto para la rejilla rígida como para la rejilla flexible, se recomienda utilizar el conector plástico suministrado, mantiene el espacio entre piezas y el alineado de las mismas.
- For a correct execution, so for the rigid grid as well as for the flexible grid, the recommendation is to use the plastic connector supplied that keeps the space between pieces and their alignment.
- Las rejillas flexibles, están preparadas para colocarlas con un radio mínimo de 0,82 metros.
- The flexible grids are prepared to be placed with a minimum radius of 0.82 meters.

Normas de limpieza y mantenimiento

Cleaning & Maintenance Guidelines

LIMPIEZA FINAL DE OBRA

Después de la colocación es fundamental realizar una buena limpieza para eliminar residuos de junta y, en general, suciedad de la obra. La limpieza final de la obra se debe realizar cuando el material de rejuntado haya endurecido, pero sin dejar pasar demasiado tiempo para evitar que se adhiera en el pavimento, complicando la limpieza.

Para esta operación es aconsejable el empleo de un detergente de acción ligeramente ácida que no despidan humos tóxicos y respete las juntas, el material y el usuario, **tipo Fila Deterdek o similar**. Previamente se comprobará que el producto de limpieza no afecta a las juntas ni al material cerámico.

También es posible el realizar limpieza mecánica con ayuda de maquinaria específica tipo cepillo rotativo de puas de plástico, no metálicas que puedan dañar el pavimento, o bien con cepillado manual empleando agua caliente.

La limpieza con agua a presión ayuda a la eliminación de restos de obra difíciles.

MANTENIMIENTO Y LIMPIEZA DIARIA

Para un buen mantenimiento del pavimento se aconseja el empleo de un detergente neutro de alto poder limpiador, tipo **FilaCleaner o similar**.

En los casos de suciedad orgánica intensa y acumulada en el tiempo, grasas, etc., se aconseja la utilización extraordinaria de un detergente alcalino de tipo desengrasante **tipo Fila PS/87 o similar**.

Se debe evitar el uso de detergentes que contengan cera o aceites, que puedan potenciar la incrustación de la suciedad, y reducir el antideslizamiento del pavimento.

Es importante, cambiar con frecuencia el agua de limpieza, para no arrastrar la suciedad en suspensión.

FINAL CLEANUP

After laying the flooring, any surplus grout and general dirt must be properly cleaned up. The final cleanup should be done when the grouting material has hardened, without allowing too much time to elapse in case the surplus remains stick to the floor and complicate the cleaning process.

For these operations, a slightly acidic detergent, such as Fila Deterdek, should be used which does not give off any toxic fumes, damage the tile joints or constitute a hazard for users. Test the detergent first to make sure that it does not affect the joints or ceramic tiles.

The flooring can also be cleaned mechanically, with a cleaning machine fitted with rotating brushes made of plastic bristles (since metal ones might damage the flooring), or by hand with a brush and warm water. A pressure washer can be used to clean away tougher dirt and remains.

EVERYDAY CLEANING & CARE

For the flooring's proper care, a thorough neutral detergent like **FilaCleaner** should be used.

On exceptional occasions, when there is heavy organic built-up dirt or grease, an alkaline grease-removing detergent like **Fila PS/87** should be used.

Detergents should be avoided that contain wax or oils, since they might in crust dirt even further and reduce the flooring's non-slip grip.

Tipo de suciedad incrustada Type of inc rusted dirt	Producto a utilizar Cleaning product
Grasas, bebidas, comidas, goma de zapatos o neumáticos, tintes, rotulador, etc. Fat, grease, drinks, food, rubber from footwear or tyres, ink, felt-tip pen, etc.	Detergente alcalino desengrasante tipo Fila PS/87 An alkaline grease removing detergent like FILA PS/87
Cemento, cal del agua, eflorescencias, rayas metales, óxidos, ennegrecido por los agentes atmosféricos. Cement, dissolved lime, efflorescence, metal scratches, oxides, blackened stains caused by atmospheric agents.	Detergente ácido tipo DETERDEK An acidic detergent like ETERDEK
Pintadas de grafitis. Graffiti.	Disolvente tipo Fila NO PAINT STAR A solvent like FILA NOPAINT STAR
Cera de velas, resinas arboles, residuos cinta adhesiva. Candle wax, tree resin, remains of adhesive tape.	Disolvente tipo FILASOLV A solvent like FILASOLV
Restos de juntas epóxicas. Remains of epoxy sealants.	Específico juntas epoxi Tipo CRIO de Fila An epoxy residue remover like CRIO by Fila

IMPORTANTE: Seguir las indicaciones de los fabricantes de los productos de limpieza para una correcta aplicación, respetando las normas de seguridad.

IMPORTANT: Follow the manufacturer's instructions for the cleaning product and observe any safety guidelines.

Información general

General information

CALIDAD DEL PRODUCTO

El sistema de gestión de GRES ARAGÓN está evaluado, certificado y auditado anualmente según las siguientes normas europeas. En lo que se refiere a CALIDAD ISO 9001:2015 y por lo que respecta a MEDIO AMBIENTE ISO 14001:2015.

El material de GRES ARAGÓN es conforme a las normas: europea EN 14411 y mundial ISO 13006.

* Los productos identificados como 2ª calidad no cumplen todas las exigencias de la norma citada anteriormente y podrían presentar defectos de calidad o visuales. Todas las baldosas de primera y segunda calidad cumplen con los requisitos obligatorios del anexo ZA de la norma EN-14411.

PRODUCT QUALITY

The management system of GRES ARAGÓN has been assessed and certified, and is annually audited, as meeting the requirements of the following European standards. ISO 9001:2015 for QUALITY MANAGEMENT and ISO 14001:2015 for ENVIRONMENTAL MANAGEMENT.

Our products meet the requirements of the:

* European standard EN 14411 and the worldwide standard ISO 13006. The products marked as 2nd quality do not meet all the requirements of the standard and they might have quality or visual defects. All 1st and 2nd quality tiles fully comply with the mandatory requirements of Annex ZA of EN-14411.

ANÁLISIS

Gres Aragón analiza sus productos en laboratorios acreditados oficialmente.

El control de calidad de cada lote de fabricación es realizado en el laboratorio interno de Gres Aragón con equipos calibrados y auditados.

TESTS

Gres Aragón tests its products in laboratories officially accredited.

The Quality Control of every single production batch is made at the in-house Laboratory of Gres Aragón with calibrated and audited equipment.

COLORES, DISEÑOS Y FORMATOS

Los colores, tonos, diseños y formatos que figuran en nuestra documentación son puramente indicativos.

Gres Aragón podrá variar cualquiera de estas características de su gama de productos sin previo aviso, sin que esto suponga motivo de reclamación por parte de sus clientes.

COLORS, DESIGNS AND SIZES

The colours, tones, designs and formats shown in our documentation are purely indicative.

Gres Aragón may vary any of these characteristics of its range of products without prior notice, without this being a reason for complaints from its customers.

M²/ML CONVENCIONAL

Los productos de GRES ARAGÓN no se suministran a m² o ml (metro lineal) completo, sino calculando una junta convencional de colocación. No se admitirán, por lo tanto, reclamaciones referentes al número de piezas suministradas.

La unidad de medida (m² o ml) de GRES ARAGÓN está basada en la medida de coordinación de las piezas, que es la suma de la dimensión de fabricación más la junta recomendada. La junta recomendada depende del formato y del tipo de producto. En el catálogo y en las cajas se indica la junta recomendada por formato. En el siguiente cuadro hay un resumen:

CONVENTIONAL M²/LM

GRES ARAGÓN products are not supplied in complete sqm or lm (linear meter), but calculating a conventional placement joint. Therefore, claims regarding the number of parts supplied will not be accepted.

The measurement unit (sqm or lm) of GRES ARAGÓN is based on the coordinating size of the pieces, which results from the addition of the work size plus the joint width recommended. The recommended joint depends on the format and type of product. The recommended joint by format is indicated in the catalogue and on the boxes. There is a summary in the table:

Formato	Medida fabricación	Junta recomendada	Medida coordinación
33x50	325x492 mm	8 mm	333x500 mm
33x33	325x325 mm	8 mm	333x333 mm
25x25	244x244 mm	6 mm	250x250 mm
20x20	195x195 mm	5 mm	200x200 mm
15x15 Ocean	147x147 mm	3 mm	150x150 mm
15x15 Quarry	150x150 mm	5 mm	155x155 mm
12x25	119x244 mm	6 mm	125x250 mm
25x50	244x464 mm	6 mm	250x500 mm
30x30	297x297 mm	3 mm	300x300 mm
30x60	297x297 mm	3 mm	300x600 mm
60x60	597x597 mm	3 mm	600x600 mm
60x120	600x1200 mm	3 mm	603x1203 mm
15x60	147x597 mm	3 mm	150 X600 mm
20x120	195x1200 mm	3 mm	198x1203 mm

Format	Work size	Recomended joint	Coordinating size
33x50	325x492 mm	8 mm	333x500 mm
33x33	325x325 mm	8 mm	333x333 mm
25x25	244x244 mm	6 mm	250x250 mm
20x20	195x195 mm	5 mm	200x200 mm
15x15 Ocean	147x147 mm	3 mm	150x150 mm
15x15 Quarry	150x150 mm	5 mm	155x155 mm
12x25	119x244 mm	6 mm	125x250 mm
25x50	244x464 mm	6 mm	250x500 mm
30x30	297x297 mm	3 mm	300x300 mm
30x60	297x297 mm	3 mm	300x600 mm
60x60	597x597 mm	3 mm	600x600 mm
60x120	600x1200 mm	3 mm	603x1203 mm
15x60	147x597 mm	3 mm	150 X600 mm
20x120	195x1200 mm	3 mm	198x1203 mm

La junta de colocación tiene funciones importantes para la calidad, durabilidad y buen comportamiento del revestimiento cerámico, entre ellas destacan: absorber las tensiones transmitidas por soportes, variaciones dimensionales por dilatación/contracción efecto de la temperatura y corregir las variaciones dimensionales de las baldosas con tolerancias.

The joint has important functions for the quality, durability and good performance of the ceramic tiles, among which stand out: it absorbs the stress transmitted by supports, the dimensional variations produced by the expansion / contraction effect of the temperature and it corrects the dimensional variations of the tiles with tolerances.

MEZCLA DE PIEZAS

Debido a las características propias de los materiales cerámicos, no se puede garantizar que los tonos del material suministrado sean uniformes o que no difieran de las muestras. A menudo una gama diversa de tonos corresponde a una apariencia normal. Además, determinadas series persiguen una destonificación intencionada desde el propio diseño de las piezas.

Para obtener una mezcla uniforme de tonos es recomendable, previo a su instalación, elegir cajas de palets diferentes y, a continuación, piezas de diferentes cajas.

TILES MIXING

Due to the characteristics of ceramic materials, it cannot be guaranteed that the shades of the material supplied are uniform or that they do not differ from the samples. Often a shade variation corresponds to its normal appearance. In addition, certain series pursue a deliberate shade variation starting from the own design process.

To obtain a uniform mix of shades, it is advisable, prior to installation, to choose different pallet boxes and then pieces from different boxes.

SENTIDO DE LA EXTRUSIÓN

Se recomienda colocar todas las piezas extruidas en el sentido de la extrusión, el cual es indicado por las ranuras del dorso de la baldosa.

EXTRUSION DIRECTION

It is advisable to lay all the extruded tiles in the extrusion direction, which is indicated by the grooves on the back side of the tile.

PACKING

La cantidad de piezas que contiene cada caja o el número de cajas que compone cada palet podría sufrir variaciones sin previo aviso por necesidades de producción o de logística. Por ello, se recomienda realizar los pedidos según la unidad de medida (que pueden ser piezas, metros cuadrados o metros lineales) que determina el catálogo para cada producto. En caso contrario, no se aceptarán reclamaciones respecto a posibles diferencias entre cantidades pedidas y servidas.

PACKAGING

The number of pieces per box or boxes per pallet might be altered without previous notice. So, we recommend placing orders according to the unit of measure (pieces, square metres or linear metres) indicated in the catalogue for each good. Otherwise, no claims will be accepted in case of difference between the quantity ordered and delivered.

CONDICIONES DE VENTA. PEDIDOS

Se suministrarán embalajes completos, completando hasta el número de unidades que para cada código de producto reflejan nuestros catálogos (Pzs./caja).

En pedidos de producto fuera de catálogo se suministrarán las cantidades fabricadas a tal efecto, pudiendo éstas superar hasta un 5% la cantidad solicitada.

GARANTÍA

Todos nuestros productos tienen una garantía de dos años, desde la fecha de factura de la compra, de conformidad con la legislación española y europea vigente en esa fecha.

La garantía no cubre defectos que puedan ser causados por una incorrecta colocación, uso o mantenimiento.

Pueden consultar nuestras recomendaciones de colocación, limpieza y mantenimiento en este catálogo y en la página web www.gresaragon.com en la sección "Descargas".

RESPONSABILIDAD SOBRE LAS CARACTERÍSTICAS DEL PRODUCTO

Si el material suministrado no corresponde a la calidad requerida, el cliente tiene derecho a reclamar la eliminación del defecto o el suministro de un nuevo material sin defectos. Los defectos únicamente visuales, que no afecten a la capacidad para el uso previsto autorizan al cliente a reclamar únicamente una disminución del precio.

En caso de variaciones en el tono, declinamos toda responsabilidad si el material está colocado. Dentro de la tolerancia dimensional, las diferencias en cuanto a tamaño, curvaturas y/o espesor no podrán ser objeto de reclamación.

No nos hacemos responsables de las consecuencias de una planificación incorrecta y de una colocación inapropiada. La exactitud de los esquemas de colocación y relación de cantidades de material facilitados por Gres Aragón deben ser verificados por la dirección de obra y por el distribuidor del material cerámico. Declinamos toda responsabilidad por dicha exactitud. Constituye únicamente una cortesía por parte de la empresa. Cualquier manipulación indebida del material durante la fase de colocación, la falta de protección del producto una vez colocado hasta su puesta en servicio, una limpieza de obra no adecuada, un uso indebido o mantenimiento no ordinario (por ejemplo: abrillantado, pulido, ataques químicos, etc.) puede afectar a las prestaciones de deslizamiento del producto durante su vida útil. No nos hacemos responsables de los daños ocasionados por una limpieza no conforme o con productos inapropiados.

Se recomienda reservar material sin colocar de la misma partida que el colocado por si fuese necesario realizar ensayos con posterioridad a la colocación, con el objeto de ensayar y resolver controversias sobre las prestaciones técnicas de la baldosa.

Solamente nos hacemos responsables de los productos suministrados como 1ª calidad.

NOTIFICACIÓN DE DEFECTOS - RECLAMACIONES

Al recibir el suministro, la mercancía debe ser examinada para verificar si corresponde con la que se ha pedido. Las posibles reclamaciones deberán hacerse por escrito en un plazo de 7 días.

Los defectos que sean visibles únicamente después de desembalar la mercancía, deben señalarse también por escrito como muy tarde 6 meses después del suministro de la mercancía y, en cualquier caso, antes de la colocación del material. En caso de que no se comuniquen los defectos y/o se coloque el material, la mercancía se considerará recibida y aceptada; de esa forma, cualquier derecho a indemnización desaparecerá.

La mercancía objeto de reclamación debe ser puesta a nuestra disposición para una inspección de su estado en el momento de la reclamación; si se está realizando la colocación del material, se interrumpirá de inmediato.

Si la reclamación se refiere a material ya colocado, declinamos cualquier pago de indemnización en tanto en cuanto se haya procedido al levantamiento del material sin nuestro permiso previo por escrito.

DEVOLUCIONES

El plazo máximo de la devolución de mercancía que se ha servido siguiendo instrucciones del cliente es de un mes, siempre y cuando el embalaje esté en buenas condiciones. Los portes de devolución son por cuenta del cliente.

PAGOS

Caso de pagos pendientes GRES ARAGÓN se reserva la posibilidad de suspender suministros posteriores, incluso de terminaciones.

Sobre los retrasos en el pago correrán los intereses de mora en la medida del tipo de interés bancario.

RESERVA DE PROPIEDAD

Todo el material suministrado sigue siendo propiedad de Gres Aragón hasta que todos los créditos del distribuidor sean completamente regularizados, sobre todo aquellos créditos resultantes de facturas impagadas, a los cuales tengamos derecho en el ámbito de las relaciones comerciales. Esto se aplica también a los créditos futuros o condicionales. Aunque aceptemos letras de cambio o cheques, nuestros créditos solamente serán satisfechos con el pago irrevocable de la letra o el cobro irrevocable del cheque.

Nota: Esta "Información General" así como las características técnicas reflejadas en este Catálogo, actualizan, modifican y sustituyen a las aparecidas en publicaciones anteriores. El fabricante se reserva el derecho de modificar cualquier valor, siempre dentro de norma, sin previo aviso.

Consultar siempre en www.gresaragon.com la versión más actualizada de este catálogo. Dicha edición online actualiza, modifica y sustituye a este ejemplar impreso.

SALES CONDITIONS. ORDERS

Complete packages will be supplied, completing up to the number of units that reflect our catalogue for each product code (Pcs./Box).

Orders for products out of catalogue will be supplied in the quantities manufactured for this specific purpose, which may exceed up to 5% the requested ones.

GUARANTEE

A 2-year guarantee for all our goods, starting on the date of invoicing, according to Spanish and European legislation in force at that time.

The guarantee does not cover defects that may have been caused by wrong laying, use or maintenance.

Guides and recommendations for laying, cleaning and maintenance are available in this catalogue and at the "Downloads" section in our site www.gresaragon.com

PRODUCT CHARACTERISTICS LIABILITY

If the goods delivered do not correspond to the quality requirements, the customer has the right to get the defect eliminated or to be delivered goods without defects. Visual only defects, if they do not affect the quality, authorize the customer just to get a decrease in price.

In case of shade variations, no claims will be accepted after laying.

Under the dimensional requirements, the size, flatness or thickness deviation can not be the object of claim.

The accuracy of the laying schemes and/or quantities list of materials offer have to be verified by the Works Direction and by the ceramic tiles distributor. We refuse any liability for eventual inaccuracies. These information is to be considered as a gentleness from our company.

Any improper handling of the goods during the laying phase, the lack of protection of the goods once installed until its start-up, a non-adequate after-works cleaning, any improper use or non-ordinary maintenance (i.e.: burnishing, polishing, chemical attacks, etc.) could affect the anti-slip performance characteristics of the product during its lifetime. We refuse any liability for the damages caused by a not proper cleaning or by the usage of inappropriate products.

We strongly recommend to keep a reserve of material of the same batch as the installed one in case of a need of testing arise after laying the goods, in order to test and solve controversies on the technical performance of it.

Claims are accepted only in 1st quality products.

DEFECTS NOTIFICATION - CLAIMS

When received, the goods must be examined to verify if it corresponds with the one ordered. Possible claims must be made in writing within 7 days.

Defects that are visible only after unpacking the goods must also be indicated in writing at the latest 6 months after the goods are delivered and in any case before the tiles are placed. In case the defects are not communicated and / or the material is placed, the merchandise will be considered received and accepted; therefore, any right to compensation would disappear.

The products subject to the claim must be placed at our disposal for inspection. If the material has been already placed, it will be immediately interrupted.

If claim is about a placed product, we refuse any compensation payment as long as the material has been removed without our prior written permission.

RETURNS

A Maximum period of the return of goods delivered following customer's instructions is established in one month, as long as the packaging is in good condition. The return shipping costs are on behalf of the client.

PAYMENTS

In case of unpaid invoices, GRES ARAGON reserve itself the right to cancel any further delivery.

Delays in payment will be taxed with interest on default according to commercial bank interest rates.

OWNERSHIP RESERVATION

Goods, even delivered, belong to Gres Aragón until any credits of the distributor are completely regularized. This also affects future or conditional credits. Even though we accept bills of exchange or cheques, our credits will only be settled by the irrevocable payment of the bill or the irrevocable cashing of the cheque.

Note: This "General Information" as well as the technical characteristics shown on this Catalogue, update, modify and replace those appearing in previous publications.

The manufacturer reserves itself the right to change any values, keeping it always within the Standards, without previous notice.

Always check at www.gresaragon.com the most updated version of this catalogue. The said online edition updates, modifies and replaces this printed copy.

GRES ARAGÓN

SOLUTIONS FOR LIVING

ACEPOOL
WELLNESS CERAMICS-GRES ARAGÓN

FAVEKER®
ARCHITECTURAL CERAMICS

 BIOKLINKER
TECHNOLOGY BY GRES ARAGÓN

**PORCELÁNICO
ESMALTADOS
KLINKER
LÍNEA TÉCNICA**

PORCELAIN TILES
GLAZED TILES
KLINKER
TECHNICAL RANGE

GRES ARAGÓN

SOLUTIONS FOR LIVING

ACEPOOL
WELLNESS CERAMICS GRES ARAGÓN

FAVEKER
ARCHITECTURAL CERAMICS

BIOLINKER
TECHNOLOGY BY GRES ARAGÓN

GRES DE ARAGÓN, S.A.

FÁBRICA Y OFICINAS/ FACTORY AND OFFICE:

Ctra. Escatron, 9
44600 ALCANIZ (Teruel) Spain
Tel. +34 978 830 511
Fax +34 978 833 003
gresaragon@gresaragon.com

CENTRO LOGÍSTICO Y COMERCIAL/ LOGISTIC AND COMMERCIAL CENTRE

Ctra. Villarreal-Onda, km 9
12200 ONDA (Castellón) Spain
Tel. +34 964 626 526
Fax +34 964 626 585
onda@gresaragon.com

FÁBRICA FAVEKER / FAVEKER FACTORY

Pol. El Regatillo 2,
Ctra. Alcorisa a Andorra, km 3,5
44550 ALCORISA (Teruel) Spain
faveker@gresaragon.com

www.gresaragon.com
www.faveker.com



ACREDITADO POR ENAC
* Fábricas Alcañiz y Faveker,
Centro logístico y comercial



ACREDITADO POR ENAC
* Fábricas Alcañiz y Faveker